



Service Manual

ROOFTOP PACKAGED SERVICE MANUAL

(GC2023 - I)

CAPACITY RANGE:24000~57000Btu/h(7.04~16.7kW)

OPERATION RANGE: COOLING:COOLING:23°F(-5°C)~125.6°F(52°C)

HEATING:-22°F(-30°C)~75.2°F(24°C)



Contents

PRODUCT	1
PRODUCT INTRODUCTION	2
1 MODELS LIST	2
2 NOMENCLATURE	2
3 FEATURE	3
4 PRODUCT DATA	4
4.1 PRODUCT DATA AT RATED CONDITION	4
4.2 OPERATION RANGE	5
4.3 ELECTRICAL DATA	5
5 PIPING DIAGRAM	6
CONTROL	7
UNITS CONTROL	8
1 OPERATION FLOWCHART	8
1.1 COOLING OPERATION	8
1.2 HEATING OPERATION	9
2 WIRED CONTROLLER	10
2.1 DISPLAY VIEW	10
2.2 OPERATION VIEW	11
3 OPERATION INSTRUCTIONS OF SPECIAL FUNCTIONS	13
3.1 SETTING OF FILTER CLEAN REMINDER FUNCTION	13
3.2 LOCK FUNCTION	14
3.3 MEMORY FUNCT	15
3.4 MODBUS INTERFACE	15
3.5 SWITCH BETWEEN FAHRENHEIT AND CENTIGRADE	17
3.6 ENQUIRY OF AMBIENT TEMPERATURE	17
3.7 ENQUIRY OF HISTORICAL MALFUNCTION	17
3.8 DEBUGGING FUNCTION	17
4 INSTALLATION OF WIRED CONTROLLER	20
4.1 STANDARD ACCESSORIES	20
4.2 INSTALLATION POSITION AND REQUIREMENT	21
4.3 INSTALLATION OF WIRED CONTROLLER	21
4.4 REMOVAL OF WIRED CONTROLLER	22
5 TROUBLESHOOTING	22
5.1 DISPLAY OF ERROR CODE	22
INSTALLATION	26

1 UNITS INSTALL	27
1.1 INSTALLATION POSITIONS	27
1.2 MATTERS NEED ATTENTION	27
1.3 DIMENSION	30
2 DRAIN PIPING WORK	31
2.1 INSTALLATION PROCEDURE	31
2.2 MATTERS OF ATTENTION	32
3 ELECTRIC WIRING WORK	32
3.1 WIRING PRINCIPLE	32
3.2 ELECTRIC WIRING DESIGN	35
MAINTENANCE	37
1 MALFUNCTION TABLE	38
1.1 MAIN CONTROL MALFUNCTION	38
1.2 DESCRIPTION OF DRIVE MALFUNCTION	40
2 FLOW CHART OF TROUBLESHOOTING	41
2.1 TROUBLESHOOTING FLOW CHART OF MAIN CONTROL MALFUNCTION	41
2.2 TROUBLESHOOTING FLOW CHART OF DRIVE MALFUNCTION	50
3 WIRING DIAGRAM	54
4 DISASSEMBLY AND ASSEMBLY PROCEDURE OF MAIN PARTS	55
4.1 Model: GK-H02TC/NaA-T(U),GK-H03TC/NaA-T(U)	55
4.2 Model: GK-H04TC/NaA-T(U),GK-H05TC/NaA-T(U)	64
5 EXPLODED VIEWS AND SPARE PART LIST	73
5.1 Model: GK-H02TC/NaA-T(U),GK-H03TC/NaA-T(U)	73
5.2 Model: GK-H04TC/NaA-T(U),GK-H05TC/NaA-T(U)	75

PRODUCT

PRODUCT INTRODUCTION

1 MODELS LIST

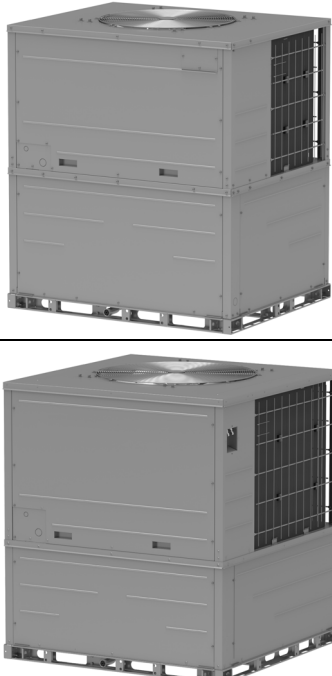
Nominal Capacity (Ton)	Model			Power Supply (V, Ph, Hz)	Appearance
	Refrigerant	Model Name	Product Code		
2	R410A	GK-H02TC/NaA-T(U)	EJ51100070	208/230 1Ph~ 60Hz	
3		GK-H03TC/NaA-T(U)	EJ51001381		
4		GK-H04TC/NaA-T(U)	EJ51100030		
5		GK-H05TC/NaA-T(U)	EJ51100020		



NOTES:

- ① Above pictures may be different from actual model.
- ② 1Ton =12000Btu/h = 3.517kW.

2 NOMENCLATURE

GK	-	H	02	T	C	/	Na	A	-	T	(U)
1	-	2	3	4	5	-	6	7	-	8	9

No.	Description	Options
1	Product Category	GK=GREE Rooftop Packaged Air-condition
2	Product Function Code	C = Cooling only type; H = Heat pump type.
3	Cooling/Heating Capacity	02=2Ton 03=3Ton.....
4	Operating Condition	T=T3 Condition; N=T1 Condition.

No.	Description	Options
5	Airflow Options	H=Horizontal; C=Convertible.
6	Refrigerant Options	Omit =R22; Na=R410A; Nh=R32.
7	Design Code	A,B,C.....
8	Voltage Options	T=208/230V, 1Ph, 60Hz;
9	Place of Export	U=North America; E=Middle East; L=Latin America.

3 FEATURE

Feature	Description
DC Inverter technology	The Gree 220V Rooftop unit equipped efficient DC compressor and fan motor fusing advanced fuzzy control, can stepless adjust the output capacity according to the space load and significantly reduce power consumption.
Non-polarity communication design	The Gree 220V Rooftop unit are strong anti-interference design, host directly connected to wired controller with two-core unshielded cable, which length can up to 100 meters.
Anti-corrosive and dustproof design	The Gree 220V Rooftop unit equipped with high anti-corrosive coating of outdoor and indoor heat exchanger, triple layer moisture proof painting PCB, IP56 standard outdoor fan motor, hermetically sealed indoor fan motor, which greatly improve the durability of product in the extreme environment.
Multi-protection design	The Gree 220V Rooftop unit build in comprehensive protection such as high/low pressure protection, over current protection, high discharge temperature protection, phase failure&sequence protection, which greatly improve the reliability of product in the extreme environment.
Multi parameter throttling control design	The Gree 220V Rooftop unit EXV control by the MCU fusing hight/low pressure, compressor discharge temperature, etc. Maximum optimize the unit operation process.
Dead wind start-up design	The Gree 220V Rooftop unit intergrated exclusive outdoor fan dead wind start-up fuction, which greatly improve the success rates of fan start-up in the windy circumstances and ensure the unit performance steadily.
Emergency operation design	The Gree 220V Rooftop unit is composed of two independence system. When one system fails, another system continue to operate in emergency during the maintenance period.
Centralized Control	The Gree 220V Rooftop unit support centralized control fuction. One centralized controller can control up to 36 host.
Remote control function	The Gree 220V Rooftop unit support remote control function, host can be access and control through LAN and WAN(Gateway accessory are required).

4 PRODUCT DATA

4.1 PRODUCT DATA AT RATED CONDITION

Model			GK-H02TC/NaA-T(U)	GK-H03TC/NaA-T(U)
Capacity	Cooling	kW	7.03	10.08
		BTU/h	24000	34400
	Heating	kW	7.03	10.55
		BTU/h	24000	36000
SEER		-	17.8	17.8
HSPF		-	8.8	8.8
EER		(Btu/h)/W	11	11
COP		W/W	3.4	3.4
Power supply		V/Ph/Hz	208/230/1/60	208/230/1/60
MOP		A	40	40
MCA		A	35	35
Refrigerant charge volume		lbs	11	11
Sound pressure level		dB(A)	63	63
Dimension (W×D×H)	Outline	in	44-1/8×35-3/8×49-3/16	44-1/8×35-3/8×49-3/16
	Package	in	44-5/8×35-15/16×50-13/16	44-5/8×35-15/16×50-13/16
Net weight/Gross weight		lbs	523/545	523/545
Loading quantity	40'GP/40'HQ	unit	26/52	26/52

Model			GK-H04TC/NaA-T(U)	GK-H05TC/NaA-T(U)
Capacity	Cooling	kW	13.77	16.41
		BTU/h	47000	56000
	Heating	kW	13.77	16.71
		BTU/h	47000	57000
SEER		-	17.8	17
HSPF		-	8.5	8.3
EER		(Btu/h)/W	11	10.6
COP		W/W	3.24	3.18
Power supply		V/Ph/Hz	208/230/1/60	208/230/1/60
MOP		A	45	45
MCA		A	39.1	39.1
Refrigerant charge volume		lbs	14.8	14.8
Sound pressure level		dB(A)	68	68
Dimension (W×D×H)	Outline	in	44-1/8×44-1/8×49-3/16	44-1/8×44-1/8×49-3/16
	Package	in	44-5/8×44-5/8×50-13/16	44-5/8×44-5/8×50-13/16
Net weight/Gross weight		lbs	628/650	628/650
Loading quantity	40'GP/40'HQ	unit	20/40	20/40

**NOTES:**

- ① The cooling capacity stated above is measured under following conditions:
 - Indoor Conditions: 26.7°C DB/19.4°C WB (80.1°F DB/66.9°F WB).
 - Outdoor Conditions: 35°C DB/24°C WB (95°F DB/76°F WB).
- ② The heating capacity stated above is measured under following conditions:
 - Indoor Conditions: 21.1°C DB/15.6°C WB (70°F DB/60°F WB).
 - Outdoor Conditions: 8.3°C DB/6.1°C WB (46.9°F DB/42.9°F WB).
- ③ The air volume is measured at the relevant standard external static pressure.
- ④ The technical parameters are changed along with the products improvement; please refer to the nameplate of the unit for actual data.
- ⑤ Above data is subject to change without notice.

4.2 OPERATION RANGE

Item	Outdoor Condition°C (°F)
Cooling	-5(23)~52(125.6)
Heating	-30(-22)~24(75.2)

4.3 ELECTRICAL DATA

Model	Power supply	Fuse capacity (A)	Maximum over-current protection(A)	Minimum circuit ampacity(A)
GK-H05TC/NaA-T(U) GK-H04TC/NaA-T(U)	208/230V-1Ph-60Hz	45	45	39.1
GK-H03TC/NaA-T(U) GK-H02TC/NaA-T(U)	208/230V-1Ph-60Hz	40	40	35

5 PIPING DIAGRAM

GK-H02TC/NaA-T(U), GK-H03TC/NaA-T(U), GK-H04TC/NaA-T(U), GK-H05TC/NaA-T(U):

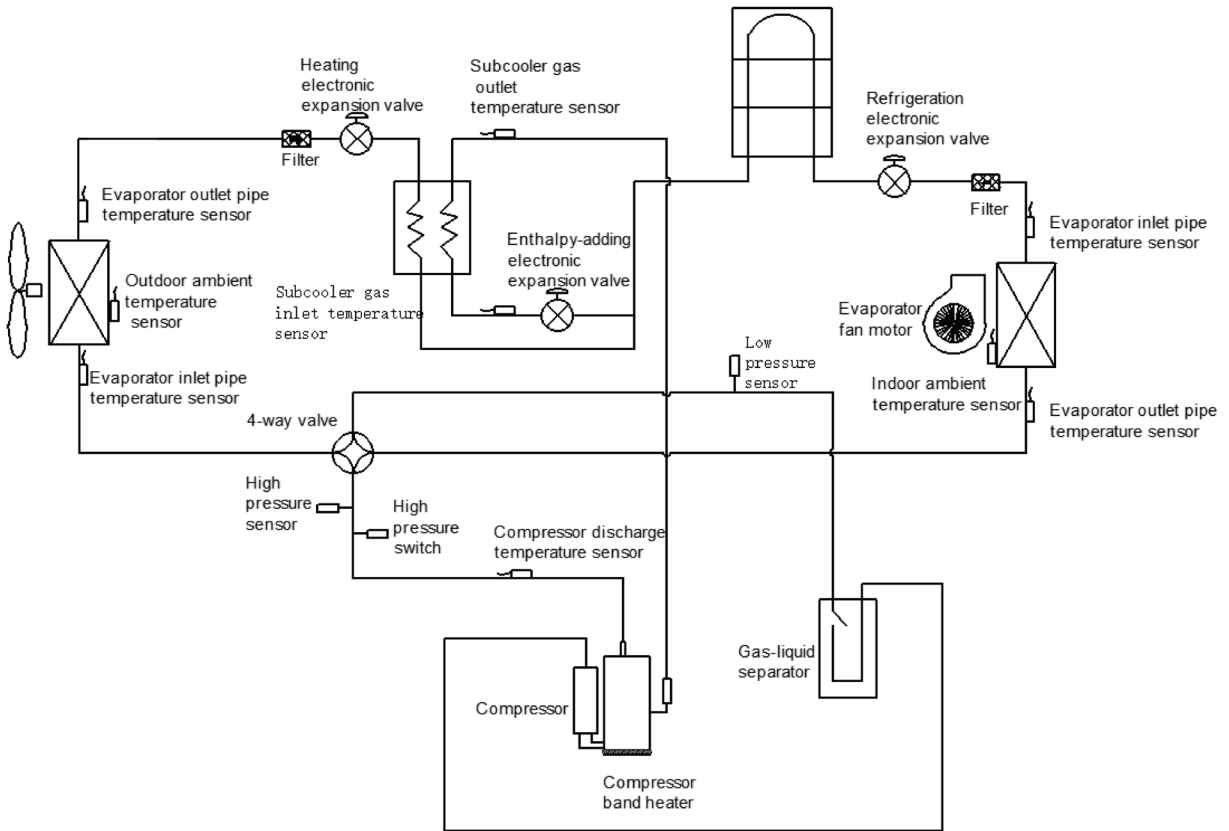

CONTROL

UNITS CONTROL

1 OPERATION FLOWCHART

1.1 COOLING OPERATION

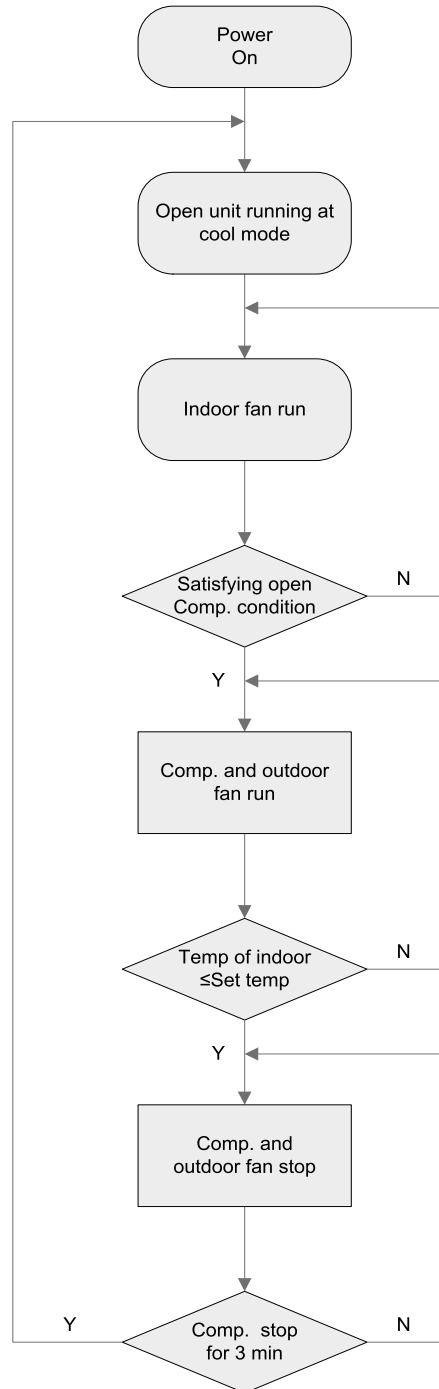

1.2 HEATING OPERATION

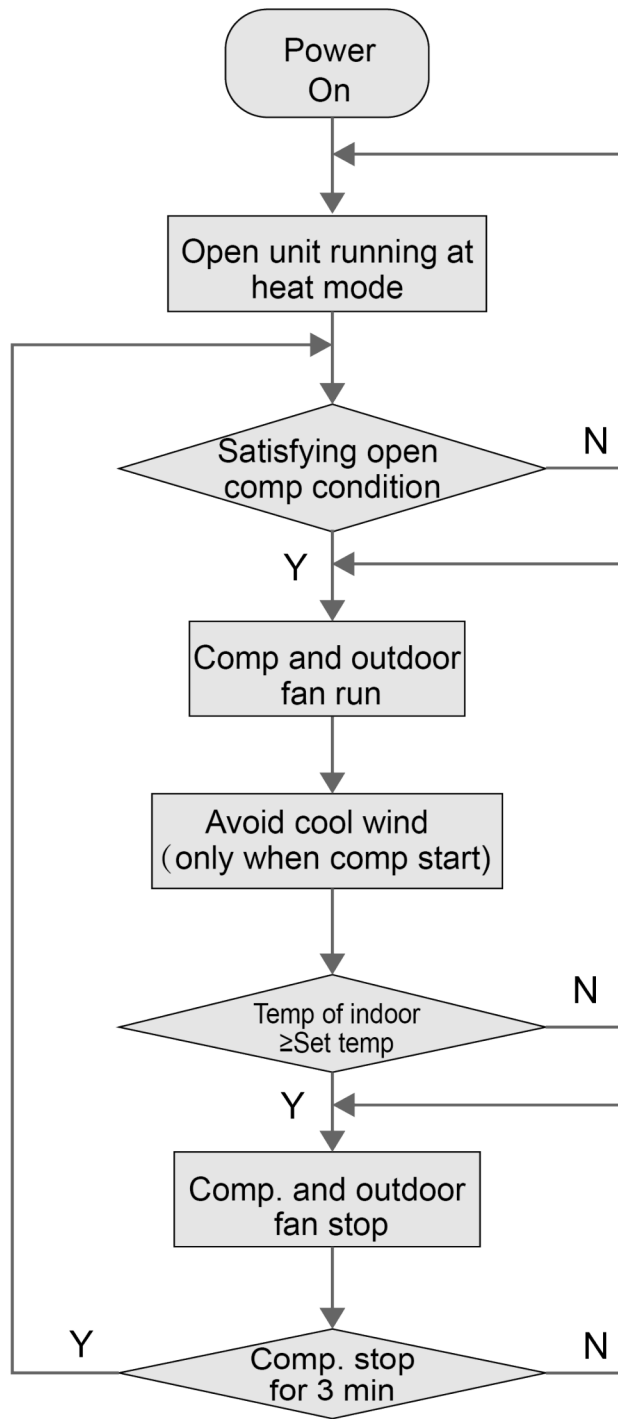

2 WIRED CONTROLLER

2.1 DISPLAY VIEW

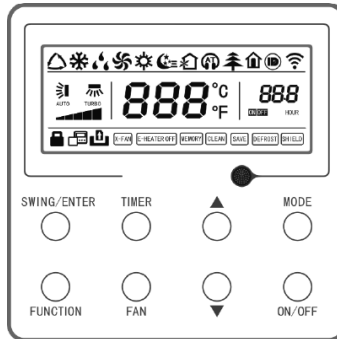

Figure 2-1-1 Appearance of wired controller

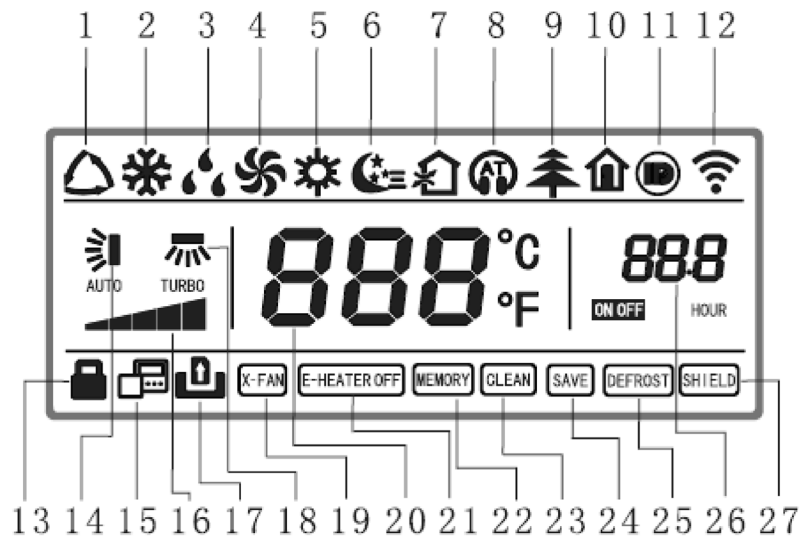

Figure 2-1-2 LCD display of wired controller

Table 2-1-1 Instruction to LCD Display

No.	Display	Introduction
1	Auto	Automatic mode (under auto mode, the indoor unit will select its operating mode according to the variation of room temperature)
2	Cool	Cooling mode
3	Dry	Dry mode
4	Fan	Fan mode
5	Heat	Heating mode
6	Sleep	Display when sleep function is set (only display sleep mode II)
7	Exchange	Display when air exchange function is set
8	Silent	Display when silent function is set (only display silent, no AT)
9	Health	Display when health function is set
10	Absent	Display when absent function is set
11	I-Demand	Display when I-DEMAND function is set
12	WiFi	WiFi function icon

No.	Display	Introduction
13	Child-lock	Child-lock status, display when child-lock function is set
14	Up&down swing	Display when up and down swing function is set
15	Slave wired controller	Icon of slave wired controller, it will display when slave wired controller is set
16	Fan speed	The fan speed set currently (including auto, low, medium and low, medium, medium and high, high, and turbo)
17	No card	No card in gate control system
18	Left&right swing	Display when left and right swing function is set
19	X-fan	Display when dry function is set
20	Temperature	It will display the setting temperature
21	E-heater	On/off switch of auxiliary heating
22	Memory	Memory status (After power failure and re-energizing the unit, it will resume to ON/OFF status of unit before the power failure)
23	Clean	Filter washing reminder
24	Save	Display when energy-saving function is set
25	Defrost	Defrosting status
26	Timer	Display when timer status is set
27	Shield	Shielding status

2.2 OPERATION VIEW

2.2.1 Silk Screen of Buttons

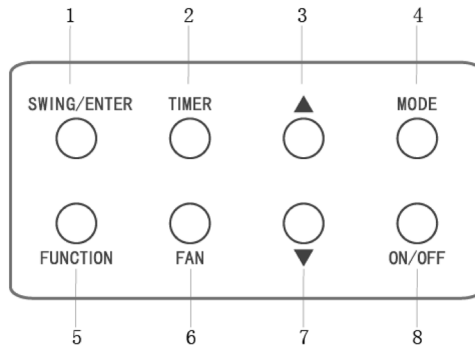

Figure 2-2-1 Silk screen of buttons

2.2.2 Instruction to Function of Buttons

Table 2-2-1 Instruction to buttons of wired controller

No.	Description	Functions
1	Swing/Enter	Function selection and canceling; Press it for 5s to view the ambient temperature; press Mode button to select viewing outdoor ambient temperature or indoor ambient temperature.
2	Timer	Timer setting.
3	▲	Running temperature setting range of indoor unit: 16-30°C; Timer setting range: 0.5-24hr; Setting of air function level; Setting of energy-saving temperature; Setting of cleaning class.
7	▼	
4	Mode	Setting of auto/cooling/heating/fan/dry mode of indoor unit.
5	Function	Switch over among these functions of swing/air/sleep/health/I-Demand/out/turbo/save/e-heater/X-fan/clean/quiet.
6	Fan	Setting of high/medium high/medium/medium low/low/auto fan speed.
8	On/Off	Turn on/off indoor unit.
4 Mode and 3 ▲	Memory function	Press Mode and ▲ buttons at the same time for 5s under off state of the unit to Swing/Enter memory function (If memory function is set, indoor unit will resume original setting state after power failure and then power recovery. If not, indoor unit is defaulted to be off after power recovery. Ex-factory setting of memory function is on).
3 ▲ and 7 ▼	Lock	Upon startup of the unit without malfunction or under off state of the unit, press ▲ and ▼ buttons at the same time for 5s to enter lock state. In this case, any other buttons won't respond when pressing. Repress ▲ and ▼ buttons for 5s to quit lock state.
4 Mode and 5 Function	Enquiry and setting of address of wired controller	Under off state of the unit, press Mode and Function buttons at the same time for 5s to set the address.
5 Function and 2 Timer	Setting of project parameters (More details please refer to the Notes)	Under off state of the unit, press Function and Timer buttons at the same time for 5s to go to the debugging menu. Press Mode button to adjust the setting items and press ▲ or ▼ buttons to set the actual value.
4 Mode and 7 ▼	Switch between Fahrenheit and Centigrade	Under off state of the unit, press Mode and ▼ buttons at the same time for 5s to switch between Fahrenheit and Centigrade.
5 Function and 7 ▼	Viewing historical malfunction	Continuously press Function and ▼ buttons for 5s to view historical malfunction. Then press ▲ and ▼ buttons to adjust displayed contents. The timer displaying position displays the sequence of malfunction and the detailed error code. The 5th displayed malfunction is the last malfunction.
1 Swing/Enter and 4 Mode	Setting of master and slave wired controller	Under off state of the unit, press Swing/Enter and Mode buttons at the same time for 5s to set master and slave wired controller. Press ▲ or ▼ button to adjust.
1 Swing/Enter and 3 ▲	Swing angle function	Under power-off status, press "Swing/Enter" button and "▲" button simultaneously for 5 seconds, the up & down swing icon will flash, then switch for simple swing and fixed swing is done.

 **NOTES:**

The following functions can be set through Function and Timer buttons: setting of ambient temperature sensor, display setting of freeze protection error code, selecting of blowing residual heat of indoor unit, selecting door control function.

3 OPERATION INSTRUCTIONS OF SPECIAL FUNCTIONS

3.1 SETTING OF FILTER CLEAN REMINDER FUNCTION

When unit is on, press Function button to switch to filter clean reminder function. The  icon will blink and then enter setting of filter clean reminder function. Timer zone displays the set pollution level and you can press ▲ or ▼ button to adjust the level. Then press Swing / Enter button to turn on this function.

When filter clean reminder function is turned on, press Function button to switch to filter clean reminder function. The  icon will blink and press ▲ or ▼ button to adjust timer zone to display "00". Then press Swing/Enter button to cancel this function.

When setting the filter clean reminder function, timer zone will display 2 digits, of which the former indicates the pollution degree of operating place and the latter indicates the accumulated operating time of indoor unit. There are 4 types of situations:



- (1) Clean Reminder is off (Timer zone shows "00").
- (2) Slight pollution: the former digit in timer zone shows 1 while the latter one shows 0, which indicates the accumulated operating time is 5500hr. Each time the latter digit increases 1, the accumulated operating time increases 500hr. When it reaches 9, it means the accumulated operating time is 10000hr.
- (3) Medium pollution: the former digit in timer zone shows 2 while the latter one shows 0, which indicates the accumulated operating time is 1400hr. Each time the latter digit increases 1, the accumulated operating time increases 400hr. When it reaches 9, it means the accumulated operating time is 5000hr.
- (4) Heavy pollution: the former digit in timer zone shows 3 while the latter one shows 0, which indicates the accumulated operating time is 100hr. Each time the latter digit increases 1, the accumulated operating time increases 100hr. When it reaches 9, it means the accumulated operating time is 1000hr.

The detailed pollution level and the corresponding time is as shown in Table 2-4below:

Table 3-1-1 Pollution level and corresponding time

Pollution Level	Accumulative Operating Time (Hour)	Pollution Level	Accumulative Operating Time (Hour)	Pollution Level	Accumulative Operating Time (Hour)
10	5500	20	1400	30	100
11	6000	21	1800	31	200
12	6500	22	2200	32	300
13	7000	23	2600	33	400
14	7500	24	3000	34	500
15	8000	25	3400	35	600
16	8500	26	3800	36	700
17	9000	27	4200	37	800
18	9500	28	4600	38	900
19	10000	29	5000	39	1000

If filter clean reminder function is turned on, the  icon will be on.

- (1) If cleaning time is not reached, no matter the setting is changed or not, the accumulated operating time won't be recalculated when pressing Swing/Enter button;
- (2) If cleaning time is reached, in unit on or off state,  will blink every 0.5s for reminder. Press Function button to switch to  icon and press ▲ and ▼ button to adjust the level. Then press Swing / Enter button, so the accumulated operating time won't be cleared (If the adjusted level is higher than the present accumulated operating time, the icon won't blink any more; if the adjusted level is lower than the present accumulated operating time, the icon will go on blinking).
- (3) The only way to cancel filter clean reminder function is to press Function button to switch to filter clean reminder function. The  icon will blink and press ▲ or ▼ button to adjust timer zone to display "00". In this case, the accumulated operating time will be cleared.

3.2 LOCK FUNCTION

When unit is turned on normally or turned off, pressing ▲ and ▼ buttons at the same time for 5s will turn on Lock function. LCD will display . Pressing ▲ and ▼ buttons at the same time for 5s to turn off this function.

When Lock function is turned on, any other buttons won't respond when pressing. The function can be memorized after power failure and then power recovery.

3.3 MEMORY FUNCT

Press Mode and ▲ buttons at the same time for 5s under off state of the unit to turn on or cancel memory function. If memory function is set, **MEMORY** is displayed.

If memory function is set, indoor unit will resume original setting state after power failure and then power recovery.

If memory function is not set, indoor unit is defaulted to be off after power recovery.

NOTE:

If memory function is set, indoor unit will resume original setting state after power failure and then power recovery. If cut off power with 5s after memorized content is changed, the memorized content may be abnormal. Do not cut off power within 5s after memorized content is changed.

3.4 MODBUS INTERFACE

The unit of this series has MODBUS interface. If the user needs to connect the unit to the management system of the building, please enquire Gree for the MODBUS protocol.

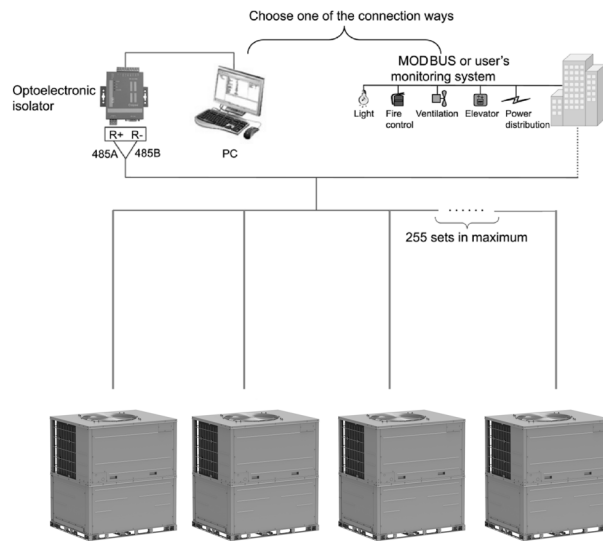

Figure 3-4-1

- (1) Interface instruction:
- 1) The printing is COM-CENT and the interface type is B2B-XH-K3.
 - 2) Electrical characteristic: baud rate: 9600bps; standard: RS485.
 - 3) Working principle.

The indoor mainboard can send out the unit operation state through this interface and receive logical control information to realize control and monitor of the unit.

(2) Function instructions:

In order to achieve this function, set the address mode and address through wired controller. Please refer to Point 3 for the setting method. You must set the address mode into long-distance control address mode.

The address mode is defaulted to be connecting to centralized controller mode and the defaulted address is 1.

(3) Setting method:

- 1) Firstly, set the address mode of wired controller into centralized controller address mode. The setting method is:

Under off state of the unit, press Function and Timer buttons at the same time for 5s to go to the debugging menu. Press Mode button to adjust to "10" in temperature displaying zone. Timer zone displays setting state and press ▲ or ▼ button to adjust. There are 2 selections:

- (1) Centralized controller address mode (LCD displays 00).
- (2) Long-distance control address mode (LCD displays 01).

Choose the second selection and then press Swing/Enter button to save and exit setting. Now, the address of wired controller is set to match the address of long-distance control. The unit will memorize this setting status. The setting value will be memorized after power failure. Address setting of each unit: when the address mode is set to be long-distance control address mode. The address setting value range is 01~255. The setting method is:

Under off state of the unit, press Function and Mode buttons at the same time for 5s to enter setting interface of wired controller address. LCD displays address sequence. Press ▲ or ▼ button to adjust the address sequence and then press Swing/Enter button to confirm. The setting value will be memorized after power failure.

NOTE:

- ① In order to realize the MODBUS interface function, the address mode of the unit must be set into long-distance control address mode; you can not set it into centralized control address mode, otherwise, this function can not be realized.
- ② The unit can not be connected to MODBUS and centralized controller at the same time; only one of them can be selected.
- ③ 255 sets of unit in maximum can be connected in the same network; the unit addresses in the same network must be different, otherwise, the unit control will be affected.
- ④ Perform wiring when the unit power is cut off.

3.5 SWITCH BETWEEN FAHRENHEIT AND CENTIGRADE

Under off state of the unit, press Mode and ▼ buttons at the same time for 5s to switch between Fahrenheit and Centigrade.

3.6 ENQUIRY OF AMBIENT TEMPERATURE

Under off or on state of the unit, press Swing/Enter for 5s to view the ambient temperature. In this case, timer zone displays ambient temperature type 01 or 02. Ambient temperature zone displays the corresponding temperature of that type. 01 stands for outdoor ambient temperature and 02 stands for the indoor ambient temperature after compensation. Press Mode button to switch between 01 and 02. Pressing other buttons except Mode button or receiving remote control signal will exit enquiry state. If there is no operation within 20s will also exit enquiry state.

NOTE:

- ① If the unit is not connected to outdoor ambient temperature sensor, display of outdoor ambient temperature will be shielding after energizing for 12hr.
- ② If there is malfunction of outdoor ambient temperature sensor, display of outdoor ambient temperature will be shielding after energizing for 12hr.

NOTE:

(for this air-condition):

When you want to enquiry outdoor ambient temperature, "00" will displayed for 3 seconds, and then the temperature will turn to the setted temperature.

3.7 ENQUIRY OF HISTORICAL MALFUNCTION

Under off or on state of the unit, continuously press Function and ▼ buttons for 5s to view historical malfunction.

In enquiry state, set temperature displaying zone displays "00". Press ▲ and ▼ buttons to view the 10 malfunctions happened recently. The timer displaying position displays the detailed error code. The 10th displayed malfunction is the last malfunction.

3.8 DEBUGGING FUNCTION

Under off state of the unit, press Function and Timer buttons at the same time for 5s to go to the debugging menu. Press Mode button to adjust the setting items and press ▲ or ▼ button to set the actual value.

3.8.1 Setting ambient temperature sensor (dual ambient temperature sensors function)

Under debugging state, press Mode button to adjust to “00” in temperature displaying zone. Timer zone displays setting state and press ▲ or ▼ button to adjust. There are 3 selections:

- (1) The ambient temperature at air return is set as indoor ambient temperature (timer zone displays 01).
- (2) The temperature at wired controller is set as indoor ambient temperature (timer zone displays 02).
- (3) Select the temperature sensor at air return in cooling, dry and fan mode; select the temperature sensor at wired controller in heating and auto mode.

3.8.2 Displaying setting of freeze protection error code

Under debugging state, press Mode button to adjust to “02” in temperature displaying zone. Timer zone displays setting state and press ▲ or ▼ button to adjust. There are 2 selections:

- (1) Displayed (LCD displays 01).
- (2) Not displayed (LCD displays 02).

It is defaulted to be not displayed for export unit and be displayed for domestic unit.

3.8.3 Setting refrigerant lacking protection function

Under debugging state, press Mode button to adjust to “04” in temperature displaying zone. Timer zone displays setting state and press ▲ or ▼ button to adjust. There are 2 selections:

- (1) With refrigerant lacking protection function (LCD displays 01).
- (2) Without refrigerant lacking protection function (LCD displays 02).

3.8.4 Selecting blowing residual heating of indoor unit

Under debugging state, press Mode button to adjust to “05” in temperature displaying zone. Timer zone displays setting state and press ▲ or ▼ button to adjust. There are 2 selections:

- (1) Mode 1 (LCD displays 00).
- (2) Mode 2 (LCD displays 01).

NOTE: Blowing residual heating of indoor unit.

Mode 1: Unit stops when reaching temperature point and indoor fan motor does not stop in cooling mode; after unit stops when reaching temperature point in heating mode, unit blow residual heat for 60s and then stop indoor unit.

Mode 2: After unit stops when reaching temperature point, the indoor fan motor stops operation with a 10s delay no matter in cooling mode or in heating mode.

3.8.5 Mode selecting of compressor electric heating belt

Under debugging state, press Mode button to adjust to “06” in temperature displaying zone. Timer zone displays setting state and press ▲ or ▼ button to adjust. There are 2 selections:

- (1) Mode 1 (LCD displays 00).
- (2) Mode 2 (LCD displays 01).

NOTE:

Mode 1: Compressor electric heating belt starts when outdoor ambient temperature is below 35°C and stops when outdoor ambient temperature is above 37°C. When outdoor ambient temperature is within 35°C~ 37°C, the belt will keep its previous operation state.

Mode 2: Compressor electric heating belt starts when outdoor ambient temperature is below -2°C and stops when outdoor ambient temperature is above 0°C. When outdoor ambient temperature is within -2°C~0°C, the belt will keep its previous operation state.

3.8.6 Selecting door control function

Under debugging state, press Mode button to adjust to “08” in temperature displaying zone. Timer zone displays setting state and press ▲ or ▼ button to adjust. There are 2 selections:

- (1) Without door control function (LCD displays 00).
- (2) With door control function (LCD displays 01).

3.8.7 Selecting long-distance monitoring or centralized controller

Under debugging state, press Mode button to adjust to “10” in temperature displaying zone. Timer zone displays setting state and press ▲ or ▼ button to adjust. There are 2 selections:

- (1) Centralized controller (LCD displays 00).
- (2) Long-distance monitoring (LCD displays 01).

3.8.8 Selecting compensation of temperature sensor at air return

Under debugging state, press Mode button to adjust to “12” in temperature displaying zone. Timer zone displays setting state and press ▲ or ▼ button to adjust. There are 16 selections:

- (1) Compensate 0°C (LCD displays 00).
- (2) Compensate 1°C (LCD displays 01).
- (3) Compensate 2°C (LCD displays 02).
- (4) Compensate 3°C (LCD displays 03).
- (5) Compensate 4°C (LCD displays 04).
- (6) Compensate 5°C (LCD displays 05).
- (7) Compensate 6°C (LCD displays 06).
- (8) Compensate 7°C (LCD displays 07).
- (9) Compensate 8°C (LCD displays 08).

- (10) Compensate 9°C (LCD displays 09).
- (11) Compensate 10°C (LCD displays 10).
- (12) Compensate 11°C (LCD displays 11).
- (13) Compensate 12°C (LCD displays 12).
- (14) Compensate 13°C (LCD displays 13).
- (15) Compensate 14°C (LCD displays 14).
- (16) Compensate 15°C (LCD displays 15).

NOTE:

Indoor ambient temperature compensation can be set through wired controller (E.g. If 02 is selected, it indicates the compensation temperature is 2°C. If the indoor ambient temperature detected by the temperature sensor at air return is 29°C, the ambient temperature after compensation is 29°C-2°C=27°C).

After finishing setting, press Swing/Enter button to save and exit setting. After entering this interface, the system will exit this menu if there is no operation on the button within 20s. Normal off state interface will be displayed and present setting will not be saved.

4 INSTALLATION OF WIRED CONTROLLER

4.1 STANDARD ACCESSORIES

Table 4-1-1 Standard Accessories of Wired Controller

No.	①	②	③	④
Name	wired controller	screw M4×25	installing box of wired controller	junction box for installing inside the wall
Quantity	1	2	1	1(prepared by user)

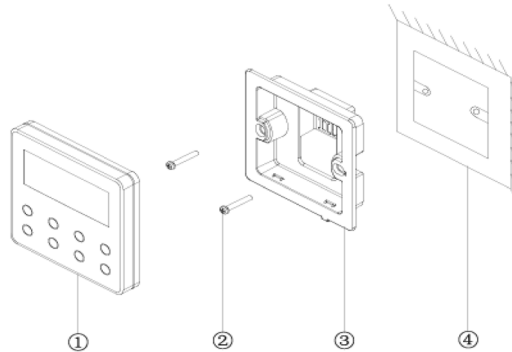

Figure 4-1-1

4.2 INSTALLATION POSITION AND REQUIREMENT

- (1) Please do not install the wired controller in the position where is wet or is likely to be splashed with water.
- (2) Please do not install the wired controller near high-temperature objects or under direct sunlight.
- (3) Please do not install the wired controller in the position where facing the window, so as to avoid interference of neighbor's remote controller with the same model and cause malfunction.
- (4) Before installation, please cut off the power supply of strong current wire inside the wall, it is not allowed to install under electrified status.
- (5) In order to avoid malfunction due to electromagnetic interference and other causes, please pay attention to the following notices:
 - 1) Make sure that the interface of communication wire is correct, otherwise the communication cannot work.
 - 2) Signal wire of wired controller should be separated from the power cord and indoor and outdoor connecting wire, the shortest distance should be over 20cm, otherwise the communication cannot work normally.
 - 3) If the unit is installed in the position where is likely to be impacted by electromagnetic interface, signal wire of wired controller should be made of STP (shielded twisted pair).
- (6) The wired controller should only be installed indoors, and its working temperature range is 0°C~50°C.

4.3 INSTALLATION OF WIRED CONTROLLER

First to select the right signal wire of wired controller: 2 - core signal wire (wire diameter \geq 0.75mm, length $<$ 30m, recommendable length is 8m).

For installation steps of wired controller please refer to the following sketch map, brief instructions are as below:

- (1) Before installation, please cut off the power supply of indoor unit, live working during installation is not allowed.
- (2) Pull out the 2-core STP inside the wall from the installing hole, thread the wire through the connecting hole in the back of soleplate of wired controller.
- (3) Stick the soleplate of wired controller on the wall, use screw M4 \times 25 to fix the soleplate onto the installing hole of wall.
- (4) Connect the 2-core STP with the two wiring terminals in the back of wired controller respectively, and screw up the screw; no polarity for these two wiring terminals, but note that it should not be connected to strong current.
- (5) Buckle the panel of wired controller with the soleplate, then the installation is finished.

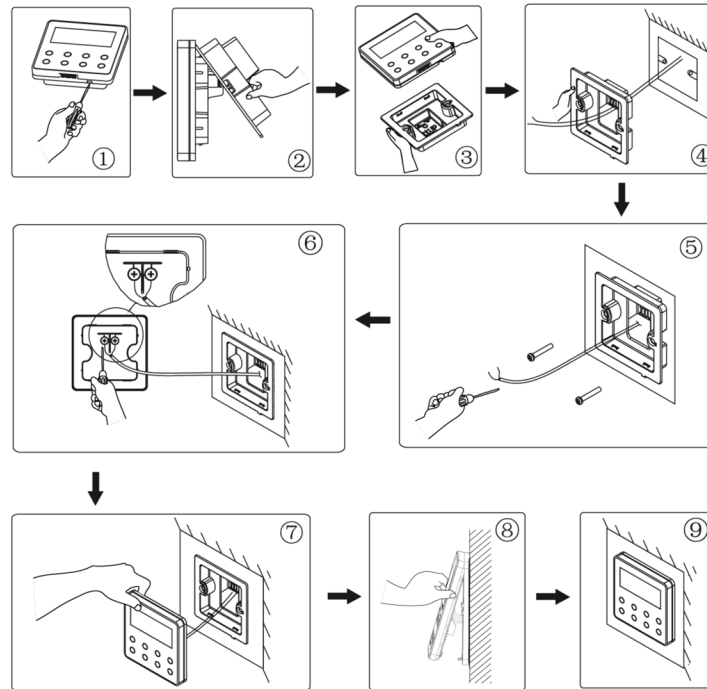

Figure 4-3-1 Installation of wired controller

4.4 REMOVAL OF WIRED CONTROLLER

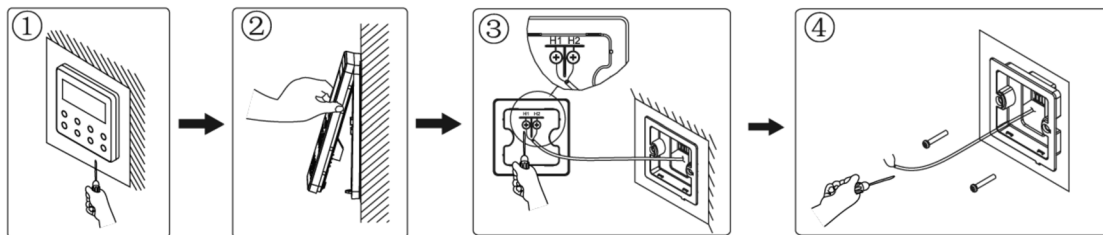

Figure 4-4-1 Removal of wired controller

5 TROUBLESHOOTING

5.1 DISPLAY OF ERROR CODE

Table 5-1-1 Error Code List 1

No.	Error code	Error	Remarks
1	E1	Compressor high pressure protection	
2	E2	Indoor anti-freeze protection	
3	E3	Compressor low pressure protection, refrigerant lack protection and refrigerant colleting mode	
4	E4	Compressor high discharge temperature protection	
5	E6	Communication error	

No.	Error code	Error	Remarks
6	E8	Indoor fan motor error	
7	F0	Indoor ambient temperature sensor error	
8	F1	Evaporator temperature sensor error	
9	F2	Condenser temperature sensor error	
10	F3	Outdoor ambient temperature sensor error	
11	F4	Discharge temperature sensor error	
12	F5	Temperature sensor error of wired controller	
13	F6	Condenser mid-tube thermistor error	
14	C5	Capacity code error	
15	EE	Outdoor memory chip error	
16	PF	Electric box sensor error	
17	H3	Compressor overload protection	
18	H4	Overloading	
19	H5	IPM protection	
20	H6	DC fan motor error	
21	H7	Drive desynchronizing protection	
22	Lc	Activation failure	
23	Ld	Compressor phase sequence protection	
24	LE	Compressor stalling protection	
25	LF	Power protection	
26	Lp	Controllers incompatibility error	
27	U7	4-way valve direction changing protection	
28	P0	Drive reset protection	
29	P5	Over-current protection	
30	P6	Communication error between main control and drive	
31	P7	Drive module sensor error	
32	P8	Drive module over temperature protection	
33	P9	Zero passage protection	
34	PA	AC current protection	
35	Pc	Drive current error	
36	Pd	Sensor connecting protection	
37	PE	Temperature drift protection	
38	PL	Bus low voltage protection	
39	PH	Bus high voltage protection	
40	PU	Charge loop error	
41	PP	Input voltage abnormality	
42	ee	Drive memory chip error	
43	HC	pf _c protection	
44	C4	ODU jumper cap failure	
45	d1	DRED1 mode	
46	d2	DRED2 mode	
47	d3	DRED3 mode	
48	E9	Water overflow protection	
49	EL	Emergency Stop(Fire alarm)	

No.	Error code	Error	Remarks
50	08	Defrosting	
51	09	Oil return	

NOTE:

When several malfunctions occur at the same time, these error codes will be displayed circularly.

When there is a malfunction, please turn off the unit and ask the professional for maintenance.

Table 5-1-2 Error Code List 2

No.	Error Code	Error	Remarks
1	AL	Fan DC busbar under voltage protection	
2	AH	Fan DC busbar over voltage protection	
3	AA	Fan AC current protection (input side)	
4	A1	Fan IPM module protection	
5	AF	Fan PFC abnormality	
6	Ac	Fan startup failure	
7	Ad	Fan Missing phase	
8	A0	Fan Drive module resetting	
9	UL	Fan current protection	
10	UP	Fan power protection	
11	AE	Fan Current sensor malfunction	
12	AJ	The Fan motor in loss of synchronization	
13	A6	Malfunction from Fan driving part to main-control communication	
14	A8	Overheat protection of Fan radiator	
15	A9	Fan radiator sensor malfunction	
16	An	Fan Drive Storage chip malfunction	
17	AU	Fan Charge circuit malfunction	
18	AP	Fan AC input voltage abnormality	
19	Ar	Fan drive board environment temperature sensor malfunction	
20	U9	Fan AC contactor protection or input zero crossing error	

When there is a malfunction during operation, error will be displayed on the temperature displaying zone of LCD. When several malfunctions occur at the same time, these error codes will be displayed circularly.

When there is a malfunction, please turn off the unit and ask the professional for maintenance.

For example, E1 means high pressure protection during operation.

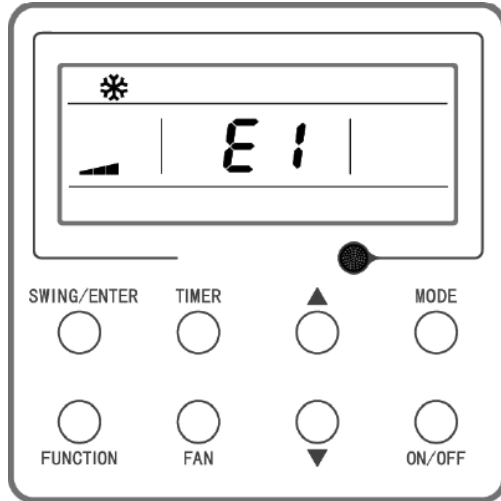

Figure 5-1-1

INSTALLATION

1 UNITS INSTALL

1.1 INSTALLATION POSITIONS

To ensure the unit in proper function, selection of installation location must be in accordance with following principles.

- (1) Unit shall be installed so that the air discharged by outdoor fan will not return and that sufficient space for repair shall be provided around the unit.
- (2) The installation site must have good ventilation, so that the unit can take in and exhaust enough air.
- (3) Place of installation shall be strong enough to support the weight of unit, and it shall be able to insulate noise and prevent vibration. Ensure that the wind and noise from the unit will not affect your neighbors.
- (4) Avoid direct sunshine over the unit. It is better to set up a sun shield as the protection.
- (5) Place of installation must be able to drain the rainwater and defrosting water.
- (6) Place of installation must ensure the unit will not subject to the influence of rubbish or oil fog.
- (7) The installation site must be at a place where the air exhaust outlet does not face strong wind.
- (8) Unit must be fixed on stable and solid surface of floor.

GK-H02TC/NaA-T(U),GK-H03TC/NaA-T(U),GK-H04TC/NaA-T(U),GK-H05TC/NaA-T(U)

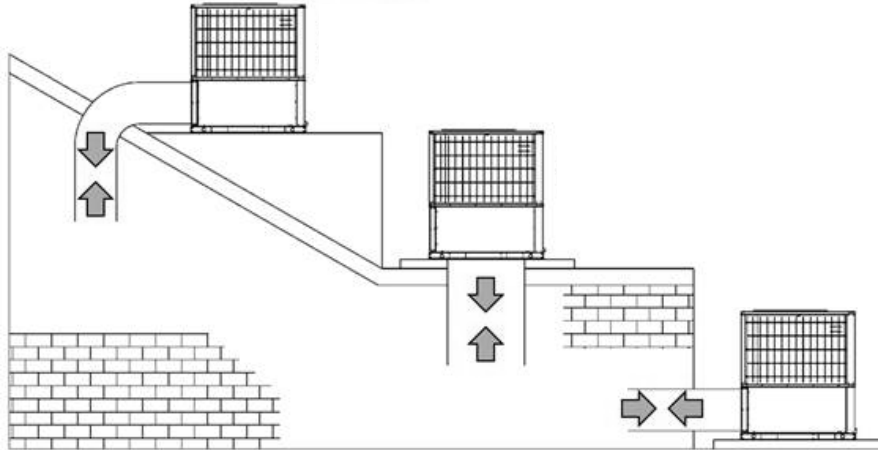

1.2 MATTERS NEED ATTENTION

1.2.1 Lifting Method

Do not remove the unit's package materials before installation. Keep unit upright and do not drop. Rig the unit by attaching chain or cable slings to the lifting holes in base rails.

Place the unit on roof curb and maintain the clearance between the roof curb and the base rail inside at 1/4inch. (6.4mm).After unit is position, remove rigging skids and package materials.

Unit:inch(mm)

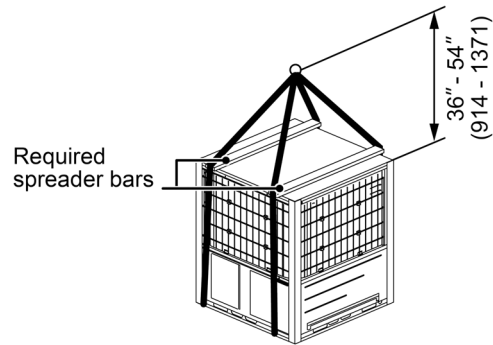

NOTICE

- | |
|---|
| (1) Spreader bars must required in order to prevent rigging straps from damaging unit. |
| (2) All panels must be in place when rigging. |
| (3) The height between the top of unit and the rigging cables' connection point should be 36-54inch (914-1371mm). |

1.2.2 Installation Pedestal

The unit must be laid on horizontal pedestal that is rigid. It is advised that pedestal is made of concrete.

The high dimension of the pedestal must larger than the dimension that needed for drainpipe installation. And the unit must be fixed on the pedestal with bolt. The location of pedestal must be able to support the weight of the unit. If not, the unit may be overturning, declining or falling off in an extreme circumstance (just like earthquake, typhoon).

GK-H02TC/NaA-T(U), GK-H03TC/NaA-T(U)

Unit:mm

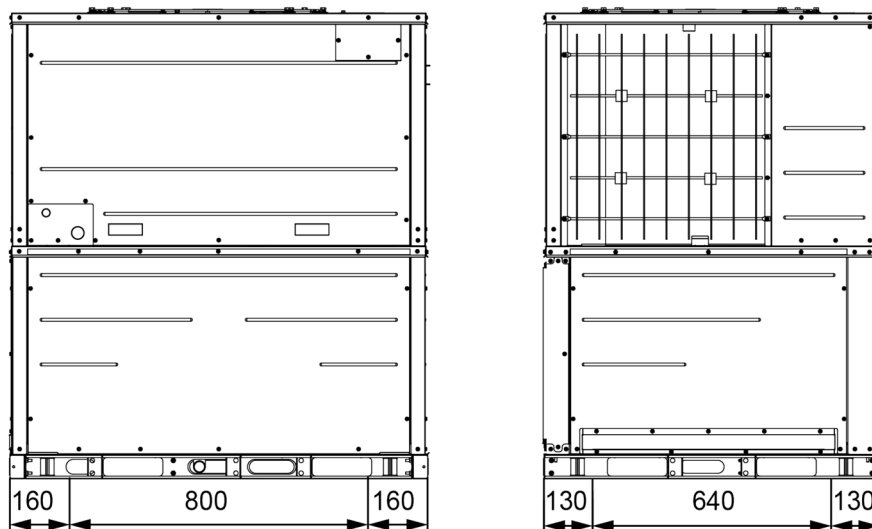

NOTE:

- ① The diagram may be different from actual model. The diagram is for pedestal made of concrete.
- ② The high dimension of the pedestal must be enough to install drainpipe (Refer to DRAIN PIPING WORK).

1.2.3 Duckwork

The design and installation of air ducts must be in conformity with the relevant local engineering criteria.

Ductwork is to be constructed in a manner that limits restrictions and maintains suitable air velocity.

The air supply duct, the air intake duct must be covered with a layer of thermal insulation, so as to avoid thermal leakage and condensation.

The air supply ducts and the air intake ducts shall be fixed by the prefabricated boards of the ceiling by using iron supports. The joints of the ducts must be sealed by glue so as to avoid leakage.

The edge of the air intake duct must be at least 150mm away from the wall.

Silencing and shock absorption shall be considered in the design and installation of the air ducts. Additionally, the noise source must be far away from where people stay. The air intake shall not be located above the place where users stay (offices and rest places, etc.).

Do not terminate the air return duct in an area that can introduce toxic or objectionable fumes/odors into the ductwork.

Each installation must include a return air filter. This filtering may be performed at the unit or externally such as a return air filter grille.

Building condition and maintenance convenience should be taken into consideration when selecting the installation method.

1.3 DIMENSION

1.3.1 Dimension of Units

GK-H02TC/NaA-T(U), GK-H03TC/NaA-T(U), GK-H04TC/NaA-T(U), GK-H05TC/NaA-T(U)

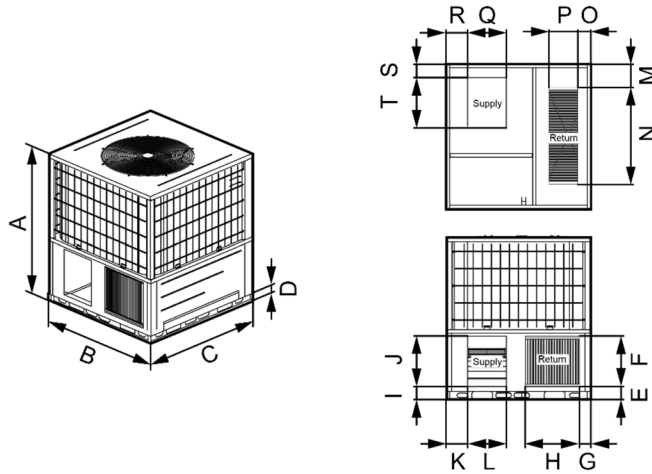

Unit:inch(mm)

Dimension	A	B		C		D		
	49-1/4 (1250)	44 (1120)		35-7/16 (900)		2-1/2 (65)		
Side air vents								
	E	Size of air return		G	I	Size of air supply		K
		F	H			J	L	
GK-H02TC/NaA-T(U) GK-H03TC/NaA-T(U)	4-7/16 (113)	17-8/16 (445)	16-9/16 (420)	3-7/16 (87)	3-15/16 (101)	15-6/16 (390)	11-13/16 (300)	6-3/16 (157)
Bottom air vents								
	M	Size of air return		O	R	Size of air supply		S
		N	P			Q	T	
	5-14/16 (149)	23-1/16 (586)	8-10/16 (219)	3-11/16 (93)	6-3/16 (156)	11-14/16 (302)	13-12/16 (350)	3-10/16 (92)

Unit:inch(mm)

Dimension	A	B		C		D		
	49-1/4 (1250)	44 (1120)		44 (1120)		2-1/2 (65)		
Side air vents								
	E	Size of air return		G	I	Size of air supply		K
		F	H			J	L	
GK-H04TC/NaA-T(U) GK-H05TC/NaA-T(U)	4 (101)	15-3/8 (390)	16-1/2 (420)	3-3/8 (87)	4 (101)	15-3/8 (390)	11-3/4 (300)	6-1/2 (166)
Bottom air vents								
	M	Size of air return		O	R	Size of air supply		S
		N	P			Q	T	
	7-7/8 (199)	28 (711)	9 (228)	3-3/4 (96)	6-1/2 (166)	11-3/4 (300)	15-3/8 (390)	4 (103)

NOTE:Above diagrams may be different from actual model.

1.3.2 Installation Clearance Data

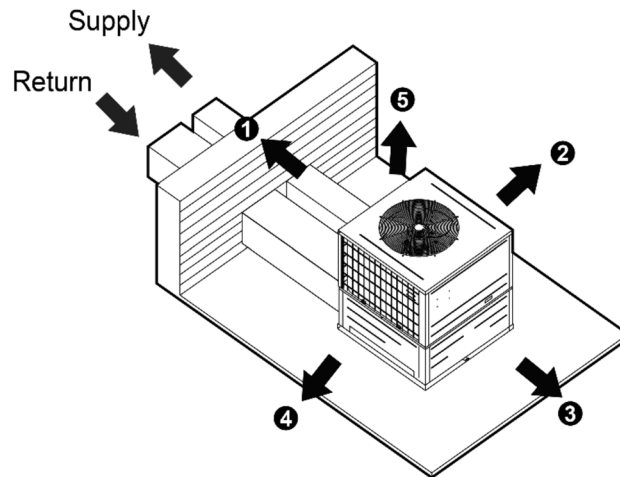

GK-H02TC/NaA-T(U), GK-H03TC/NaA-T(U), GK-H04TC/NaA-T(U), GK-H05TC/NaA-T(U)

Installation clearances		
Dimension(minimum)	mm	inch
A	600	24
B	1100	43
C	860	34
D	1100	43
E	1524	60

NOTE:Above diagrams may be different from actual mode.

2 DRAIN PIPING WORK

2.1 INSTALLATION PROCEDURE

After the unit is installed, it is required to check the level of the whole unit. The unit must be placed horizontally to ensure the unit in proper function.

When shipped out from factory, both the condensate outlets are blocked by rubber plug. So before installation, please take the rubber plug out. Condensate removal is performed by attaching a PVC pipe to the drain pan and terminated in accordance with local or state Plumbing/HVAC codes.

The indoor coil condensate drain ends with a threaded 3/4" (NPT) or 1-1/5" stub tube. A trap must be built for proper condensate drainage and to prevent debris from being drawn into the unit.

2.2 MATTERS OF ATTENTION

The condensate pipe shall be installed with an inclining angel of 5~10°, so as to facilitate the drainage of condensate.

As the inside of the unit is in the negative pressure status, it is required to set up a backwater elbow.

The requirements is: $A=B \geq P/10+20(\text{mm})$

Remark: P is the absolute pressure inside the unit. The unit of the pressure is Pa.

After the electrical installation is completed, carry out the testing of the drainage system.

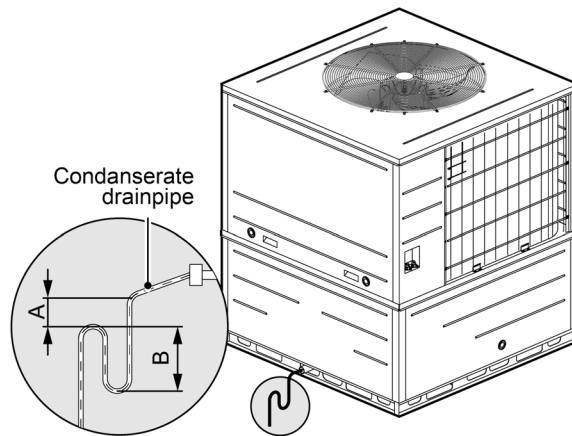

NOTE:Above diagrams may be different from actual mode.

Model	Drain connection size
GK-H02TC/NaA-T(U), GK-H03TC/NaA-T(U), GK-H04TC/NaA-T(U), GK-H05TC/NaA-T(U)	3/4"(NPT)

3 ELECTRIC WIRING WORK

3.1 WIRING PRINCIPLE

3.1.1 Precautions

- (1) Before connecting lines, read the unit nameplate for message about voltages, circuit ampacity, capacity, and so on. Then carry out line connection according to the schematic diagram.
- (2) The air-conditioning unit shall have special power supply line which shall be equipped with electricity leakage switch and air switch, so as to deal with overload conditions. Moreover, leakage switch must be tested for availability in each month (press TEST button on the switch to test).
- (3) The air-conditioning unit must have grounding to avoid hazard owing to insulation failure.
- (4) Lay out power cords through cable trough or wiring pipe. Make power cord connect into electric box through the cable-cross loop to avoid scratch of it by edges of sheet metal.
- (5) Keep distance between power line and low voltage connections above 150mm.

- (6) All line connections must conform to the schematic diagram. Wrong connection may cause abnormal operation or damage of the air-conditioning unit.
- (7) Do not let any cable contact the refrigerant pipe, the compressor and moving parts such as fan.
- (8) Do not change the internal line connections inside the air-conditioning unit. The manufacturer shall not be liable for any loss or abnormal operation arising from wrong line connections.
- (9) If the supply cord is damaged, it must be replaced by the manufacturer or its service agent or a similarly qualified person in order to avoid a hazard.
- (10) All of the supplied components, material, and electric operation should be accorded with the local principles.

3.1.2 Connect Wiring to the Terminals



CAUTIONS:

Please note the following items before installing the electric appliance.

- (1) Check if the power supply accords with its value on the nameplate.
- (2) The capacity of the power supply must be large enough.
- (3) The circuit should be installed by the professional technician.
- (4) In fixed circuit, there must be electricity leakage protection switch of enough power capacity and air switch with space between its electrode contacts $\geq 3\text{mm}$.
- (5) Single wire connection.
 - 1) Peel off the insulation for 25mm with pliers.
 - 2) Remove the screw from the terminal board.
 - 3) Bend the peeled wire into circle with pliers.
 - 4) Screw cross the circle and fix it on the terminal board.
- (6) Strand wires connection.
 - 1) Peel off the insulation for 10mm with pliers.
 - 2) Remove the screw from the terminal board.
 - 3) Clamp a round terminal of the peeled wires.
 - 4) Screw cross the circle and fix it on the terminal board.

Unit:mm

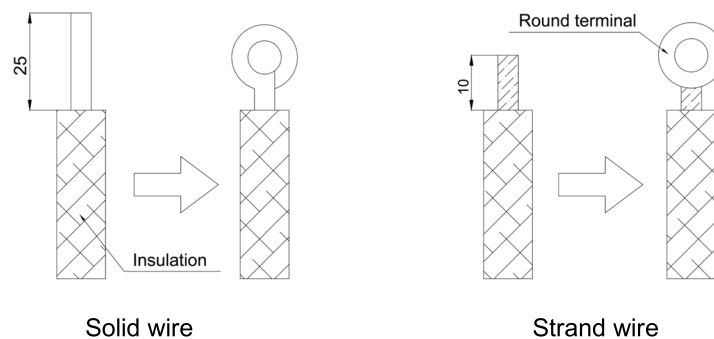

3.1.3 Electrical Connections-supply Voltage:

- (1) Air-conditioning unit with single-phase power supply.
 - 1) Remove the Electric Box Cover of the unit.
 - 2) Pass the cable through rubber ring.
 - 3) Connect the power supply cable to the terminals and the grounding screw.
 - 4) Use cable fastener to bundle and fix the cable.
- (2) Air-conditioning unit with 3-phase power supply.
 - 1) Remove the Electric Box Cover of the unit.
 - 2) Pass the cable through rubber ring.
 - 3) Connect the power supply cable to the "L1, L2, L3" terminals and the grounding screw.
 - 4) Use cable fastener to bundle and fix the cable.

(3) Low Voltage Connections

Low voltage wiring is to be copper conductors. The wire size of the communication line should be no less than 0.75mm^2 .

- 1) Remove the Electric Box Cover of the unit.
- 2) Pass the signal cable of the wire controller through rubber ring.
- 3) Connect the signal cable to the "H1,H2" terminals.
- 4) Use cable fastener to bundle and fix the cable.



CAUTIONS:

Take great care when carrying out the following connections, so as to avoid malfunction of the air-conditioning unit because of electromagnetic interference.

The signal line of the wire controller must be separated from the power line.

In case the unit is installed in a place vulnerable by electromagnetic interference, it is better to use shielded cable or double-twisted cable as the signal line of the wire controller.

3.2 ELECTRIC WIRING DESIGN

Model: GK-H02TC/NaA-T(U),GK-H03TC/NaA-T(U),GK-H04TC/NaA-T(U),GK-H05TC/NaA-T(U)

Without electric heater:

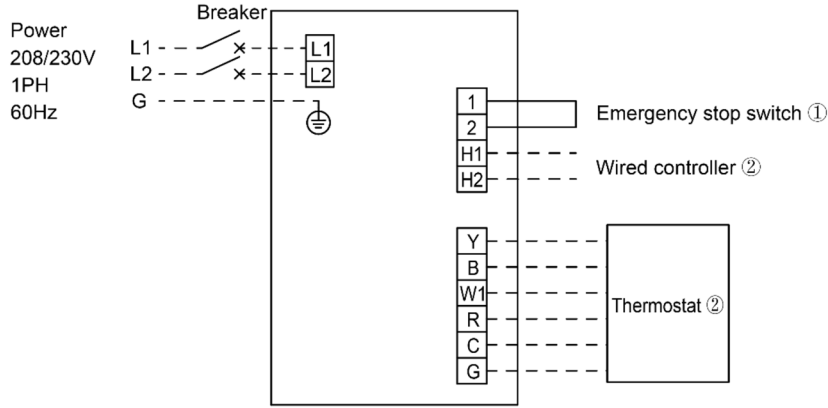

- Note: ①The factory has been short-circuited, when the user needs to connect the emergency stop switch, please remove the corresponding short-circuit wire
 ②The unit can only be connected to a thermostat or wire controller

With electric heater:

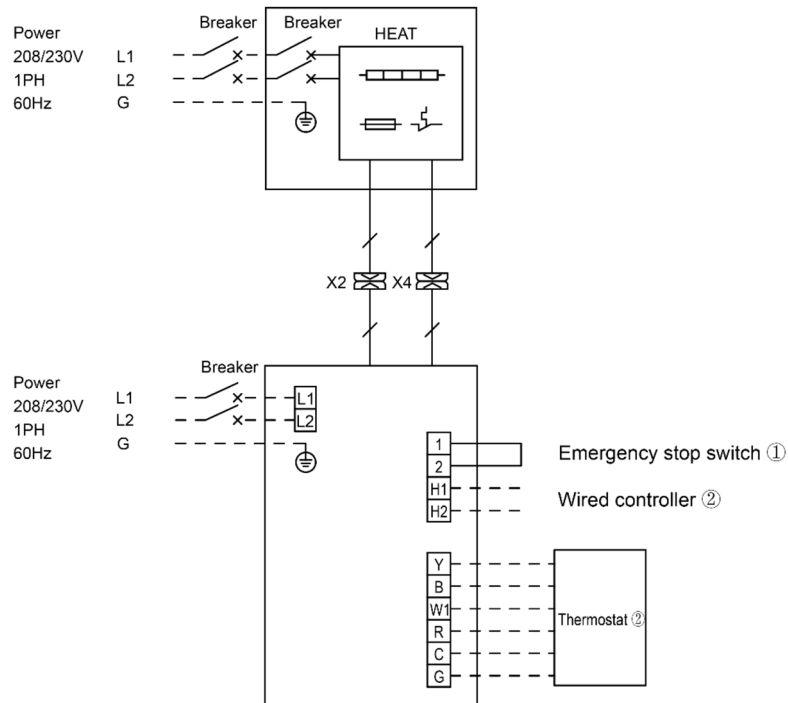

- Note: ①The factory has been short-circuited, when the user needs to connect the emergency stop switch, please remove the corresponding short-circuit wire
 ②The unit can only be connected to a thermostat or wire controller

Fig. with LYQ-08-A,LYQ-08-C

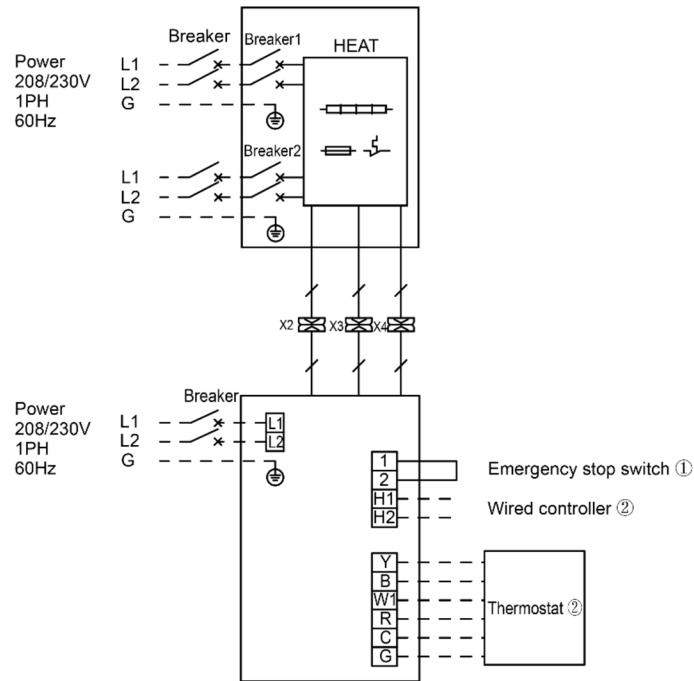

- Note: ①The factory has been short-circuited, when the user needs to connect the emergency stop switch, please remove the corresponding short-circuit wire
 ②The unit can only be connected to a thermostat or wire controller

Fig. with LYQ-08-D,LYQ-08-E

MAINTENANCE

1 MALFUNCTION TABLE

1.1 MAIN CONTROL MALFUNCTION

Table 1 Fault Display on Wired Controller

No.	Error code	Malfunction name	Origin of malfunction signal	Control description
1	E1	High pressure protection	High pressure switch	When unit detects the high pressure switch is cut off for 3s successively, high pressure protection will occur. All the loads (except the 4-way valve in heating mode) will be switched off. In this case, all the buttons and remote control signals except ON/OFF button will be disabled and cannot be recovered automatically. Switch off the unit or re-energize the unit after cutting off power to eliminate this protection.
2	E2	Freeze protection	Evaporator temperature sensor	If detecting that the evaporator temperature is lower than protective temperature value after the unit has been running for a period of time under cooling or dry mode, the unit will report this fault, in which case the compressor and condenser fan motor will be stopped. The unit will not run until evaporator temperature is higher than the protective temperature value and the compressor is stopped for 3min.
3	E3	Low pressure protection	Low pressure switch	If it is detected within 30s successively that the low-pressure switch is cut off under ON or standby state, the unit will report low pressure protection. If the fault occurs successively 3 times within 30min, the unit cannot be recovered automatically.
		Refrigerant lacking protection	/	If the unit reports system refrigerant lacking within 10min after turning on the unit, the unit will stop operation. If the fault occurs successively 3 times, the unit cannot be recovered automatically.
		Refrigerant recycling mode	/	If enter refrigerant recycling mode through special operation, E3 will be displayed. After exiting refrigerant recycling mode, the code will disappear.
4	E4	Compressor high discharge temperature protection	Compressor discharge temperature is high	If unit detects that the discharge temperature is higher than protective temperature value, the unit will report high discharge temperature protection. If the protection occurs over 6 times, the unit cannot be recovered automatically. Switch off the unit or re-energize the unit after cutting off power to eliminate this protection.
5	E6	Communication malfunction	Communication between mainboards	If the mainboard does not receive data from the other mainboards, communication malfunction will be reported. If there is communication abnormality between display board (wired controller) and the unit, communication malfunction will be reported too.
6	E8	Malfunction of evaporator fan motor	Evaporator fan motor	If the unit does not receive signal from evaporator fan motor for 30s successively when the fan motor is operating, evaporator fan motor malfunction will be reported. In this case, the unit can automatically resume operation after stopping. If the malfunction occurs 6 times within one hour, the unit cannot be recovered automatically. Switch off the unit or re-energize the unit after cutting off power to eliminate this malfunction.
7	E9	Full water protection	Water level switch	If cut-off of water level switch is detected for 8s successively once energized, the system will enter full water protection. In this case, switch off the unit and then switch it on to eliminate this malfunction.
8	F0	Malfunction of indoor ambient temperature sensor at air return port	Indoor ambient temperature sensor	If the indoor ambient temperature sensor is detected of open circuit or short circuit for 5s successively, indoor ambient temperature sensor malfunction will be reported. The unit can automatically resume operation after the malfunction disappears. If indoor ambient temperature sensor malfunction occurs in fan mode, only the error code is displayed and the unit can work normally.

No.	Error code	Malfunction name	Origin of malfunction signal	Control description
9	F1	Malfunction of evaporator temperature sensor	Evaporator temperature sensor	If the indoor evaporator temperature sensor is detected of open circuit or short circuit for 5s successively, evaporator temperature sensor malfunction will be reported. The unit can automatically resume operation after the malfunction disappears. If evaporator temperature sensor malfunction occurs in fan mode, only the error code is displayed and the indoor unit can work normally.
10	F2	Malfunction of condenser temperature sensor	Condenser temperature sensor	If the condenser temperature sensor is detected of open circuit or short circuit for 5s successively, condenser temperature sensor malfunction will be reported. The unit can automatically resume operation after the malfunction disappears. If condenser temperature sensor malfunction occurs in fan mode, only the error code is displayed and the unit can work normally.
11	F3	Malfunction of outdoor ambient temperature sensor	Outdoor ambient temperature sensor	If the outdoor ambient temperature sensor is detected of open circuit or short circuit for 5s successively, outdoor ambient temperature sensor malfunction will be reported. The unit can automatically resume operation after the malfunction disappears. If outdoor ambient temperature sensor malfunction occurs in fan mode, only the error code is displayed and the indoor unit can work normally.
12	F4	Malfunction of discharge temperature sensor	Discharge temperature sensor	If the discharge temperature sensor is detected of open circuit or short circuit for 5s successively after the compressor has been operating for 3min, discharge temperature sensor malfunction will be reported. The unit can automatically resume operation after the malfunction disappears.
13	F5	Malfunction wired controller temperature sensor	Wired controller	If the wired controller detects open circuit or short circuit of its temperature sensor for 5s successively, wired controller temperature sensor malfunction will be reported.
14	F6	Condenser mid-tube thermistor error	Condenser mid-tube temperature sensor	If the condenser mid-tube temperature sensor is detected of open circuit or short circuit for 5s successively, Condenser mid-tube thermistor error will be reported. The unit can automatically resume operation after the error disappears. If Condenser mid-tube thermistor error occurs in fan mode, only the error code is displayed and the unit can work normally.
15	ee	Malfunction of drive memory chip	Drive board	If the memory chip of drive board is broken, the unit cannot be started. The unit cannot be recovered automatically. If the malfunction cannot be eliminated after switching off the unit and then energizing the unit for several times, please replace the drive board.
16	H3	Compressor overload protection	Compressor overload switch	If it is detected within 3s successively that the overload switch is cut off under ON or standby state, the unit will report overload protection. If the fault occurs successively 3 times, the unit cannot be recovered automatically. Switch off the unit or re-energize the unit after cutting off power to eliminate this protection.
17	H4	Overload protection	Evaporator temperature, condenser temperature	If unit detects that the tube temperature is higher than protective temperature value, the unit will report overload protection. The unit will not restart operation until tube temperature is lower than the protective temperature value and the compressor is stopped for 3min. If the protection occurs over 6 times, the unit cannot be recovered automatically. Switch off the unit or re-energize the unit after cutting off power to eliminate this protection.
18	H6	Malfunction of condenser fan motor	Condenser fan motor	If the unit does not receive signal from condenser fan motor for 30s successively when the fan motor is operating, condenser fan motor malfunction will be reported. In this case, the unit can automatically resume operation after stopping. If the malfunction occurs 6 times within one hour, the unit cannot be recovered automatically. Switch off the unit or re-energize the unit after cutting off power to eliminate this malfunction.

No.	Error code	Malfunction name	Origin of malfunction signal	Control description
19	U7	Direction changing malfunction of 4-way valve	4-way valve	After the compressor starts operation in heating mode, if the unit detects the difference between evaporator temperature and indoor ambient temperature is lower than the protective value for 10min successively, direction changing malfunction of 4-way valve will be reported and the outdoor unit will stop operation. The unit can automatically resume operation in the first two malfunctions. If the malfunction occurs 3 times, the unit cannot be recovered automatically. Switch off the unit or re-energize the unit after cutting off power to eliminate this malfunction.
20	P6	Communication malfunction between main control board and drive board	Communication between main control board and drive board	If the outdoor main control board does not receive data from drive board, communication malfunction between main control and drive will be reported. This malfunction can be eliminated automatically.
21	EE	Malfunction of main control memory chip	Main control board	If the memory chip of main control board is broken, the unit cannot be started. The unit cannot be recovered automatically. If the malfunction cannot be eliminated after switching off the unit and then energizing the unit for several times, please replace the outdoor main control board.

1.2 DESCRIPTION OF DRIVE MALFUNCTION

Main board dual 8 numeral tube display codes for unit.

Malfunction Item	Wired controller display	Unit display of dual 8 numeral tube
DC busbar over-voltage protection	PH	PH
IPM or PFC over-temperature protection	P8	P8
Current sense circuit error	Pc	Pc
IPM or PFC temperature sensor error	P7	P7
Compressor current protection	P5	P5
DC busbar under-voltage protection	PL	PL
Compressor startup failure	Lc	Lc
Drive module reset	P0	P0
Compressor motor desynchronizing	H7	H7
Phase loss	Ld	Ld
Drive-to-main-control communication error	P6	P6
IPM protection	H5	H5
Compressor overload protection	H3	H3
AC current protection (input side)	PA	PA
Charging circuit error	PU	PU
DC fan error	H6	H6
Input AC voltage abnormality	PP	PP
Driving board memory chip error	ee	ee
Condenser Fan DC busbar under voltage protection	H6	AL
Condenser Fan DC busbar over voltage protection	H6	AH
Condenser Fan AC current protection (input side)	H6	AA
Condenser Fan IPM module protection	H6	A1
Condenser Fan PFC abnormality	H6	AF
Condenser Fan startup failure	H6	AC
Condenser Fan missing phase	H6	Ad
Condenser Fan Drive module resetting	H6	A0

Malfunction Item	Wired controller display	Unit display of dual 8 numeral tube
Condenser Fan current protection	H6	UL
Condenser Fan power protection	H6	UP
Condenser Fan Current sensor malfunction	H6	AE
Condenser Fan motor in loss of synchronization	H6	AJ
Malfunction from Condenser Fan driving part to main-control communication	H6	A6
Overheat protection of Condenser Fan radiator	H6	A8
Condenser Fan radiator sensor malfunction	H6	A9
Condenser Fan Drive Storage chip malfunction	H6	An
Condenser Fan Charge circuit malfunction	H6	AU
Condenser Fan AC input voltage abnormality	H6	AP
Condenser Fan drive board environment temperature sensor malfunction	H6	Ar
Condenser Fan AC contactor protection or input zero crossing error	H6	U9

2 FLOW CHART OF TROUBLESHOOTING

2.1 TROUBLESHOOTING FLOW CHART OF MAIN CONTROL MALFUNCTION

◆ E1 High Pressure Protection

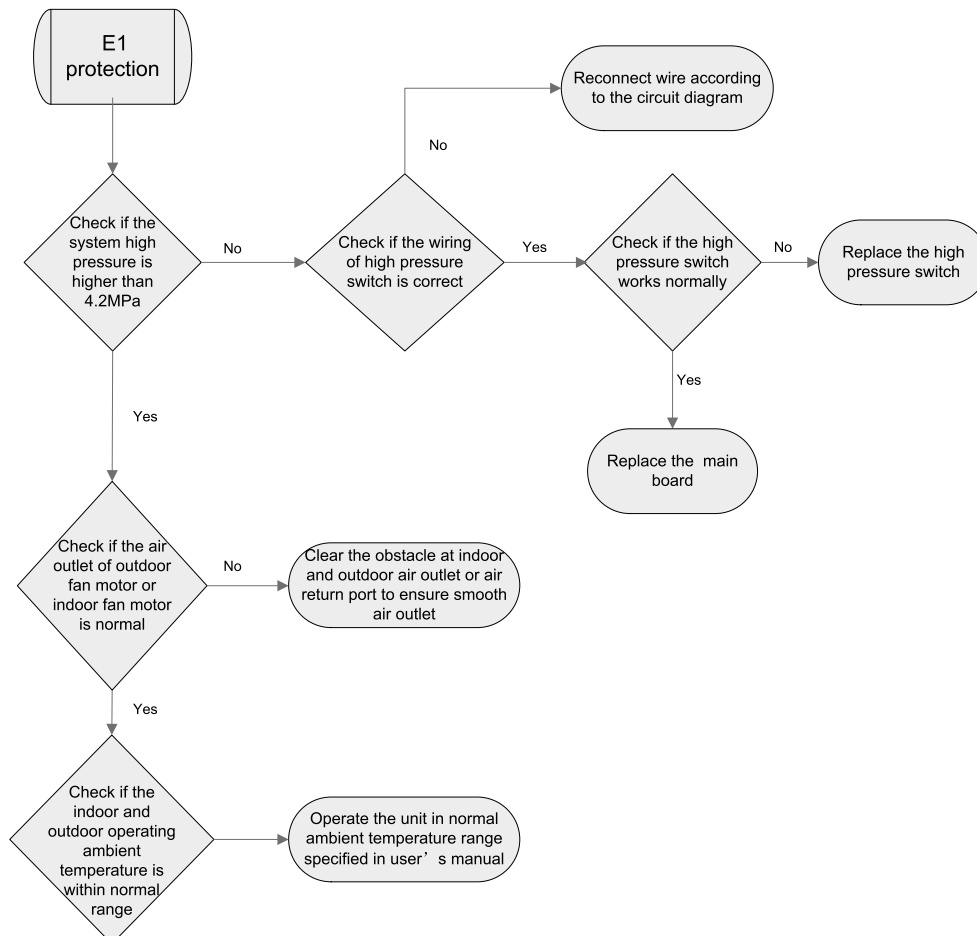

◆ E2 Freeze Protection

Freeze protection is normal protection but not abnormal malfunction. If freeze protection occurs frequently during operation, please check if the indoor filter is with filth blockage or if the indoor air outlet is abnormal. The user is required to clean the filter, check the air outlet and air return pipe periodically to ensure smooth air return and air outlet.

◆ E3 stands for three statuses:

(1) Low pressure protection.

(2) Refrigerant lacking protection.

(3) Refrigerant recycling mode.

1) If enter refrigerant recycling mode through special operation, the displayed E3 is not an error code. It will be eliminated when exiting refrigerant recycling mode.

2) If you do not want to have refrigerant lacking protection, you can enter the debugging mode through wired controller and then cancel the refrigerant lacking protection mode.

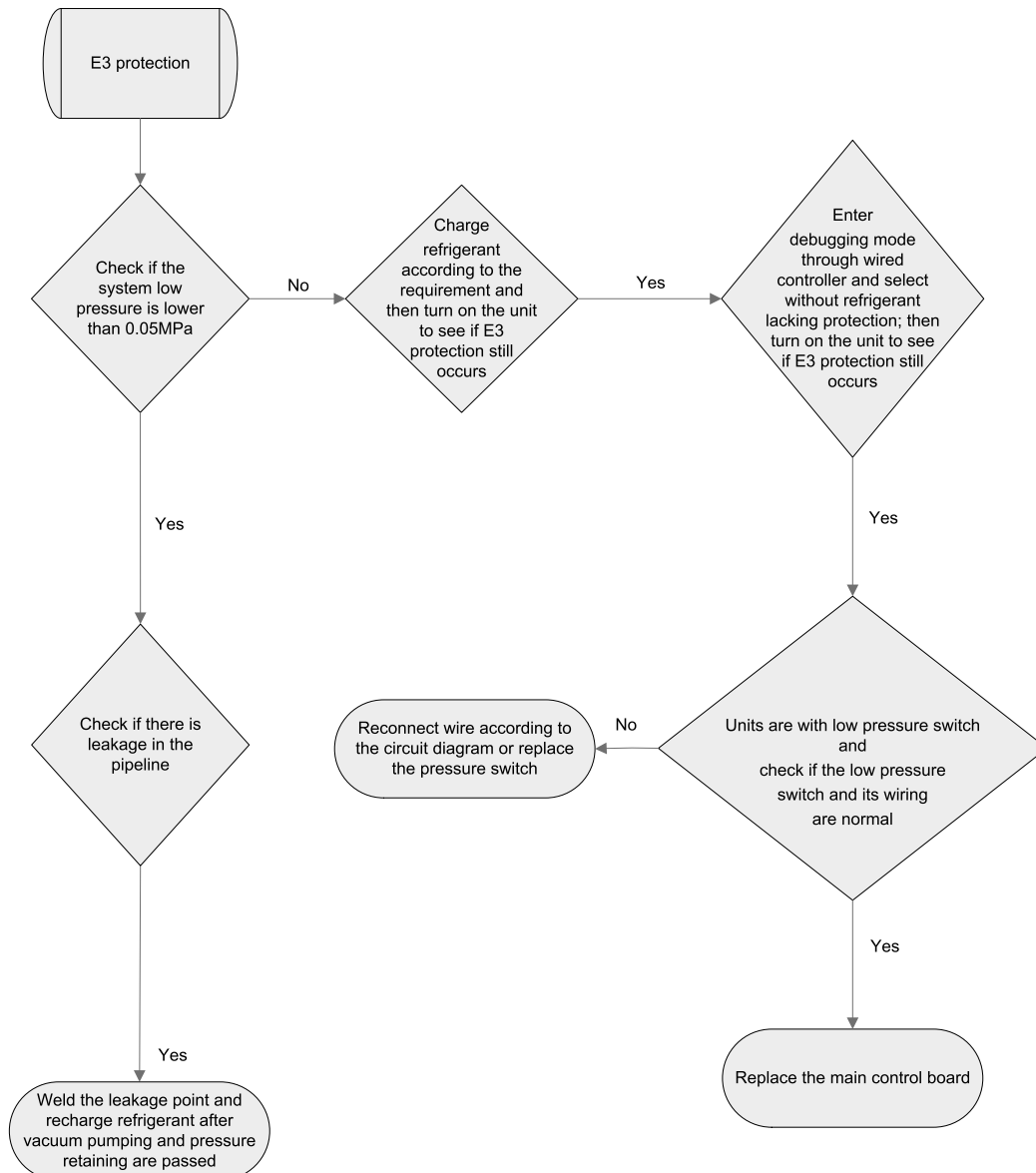

◆ E4 Discharge Protection

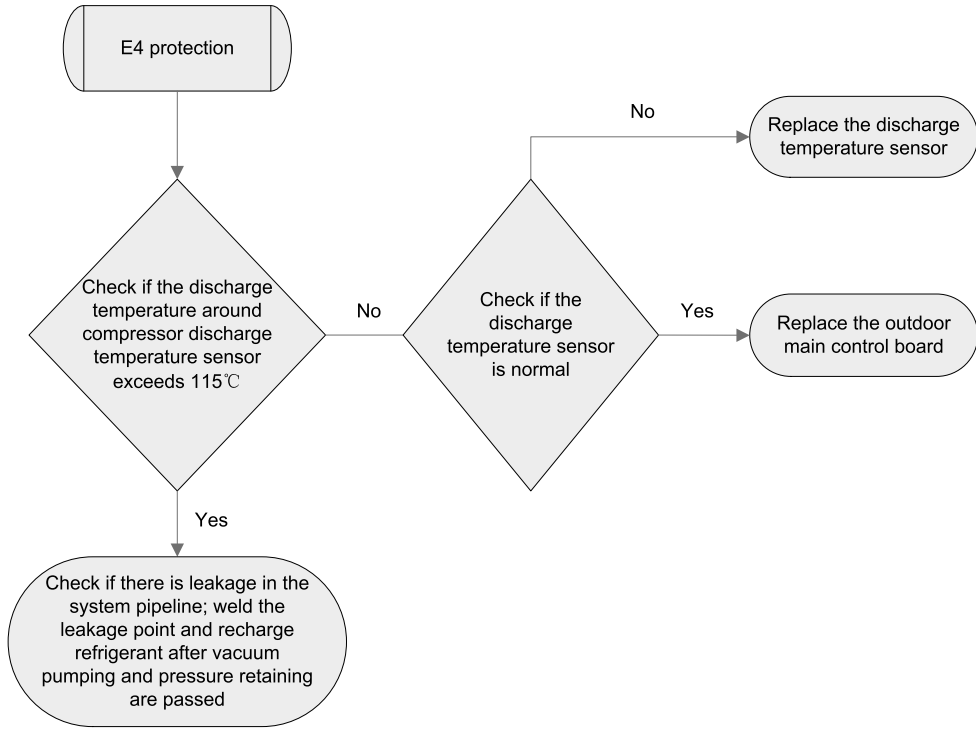

◆ E6 Communication Malfunction

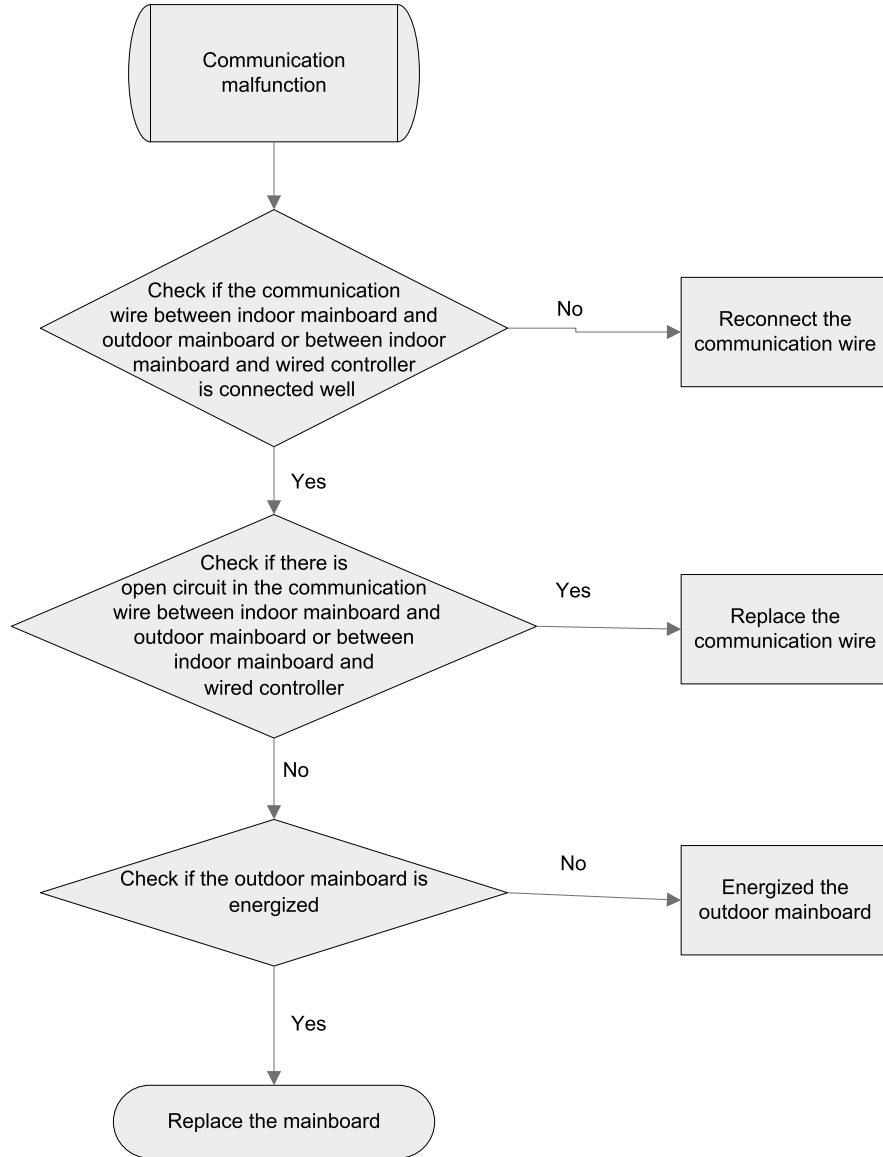

◆ F0 Malfunction of Indoor Ambient Temperature Sensor

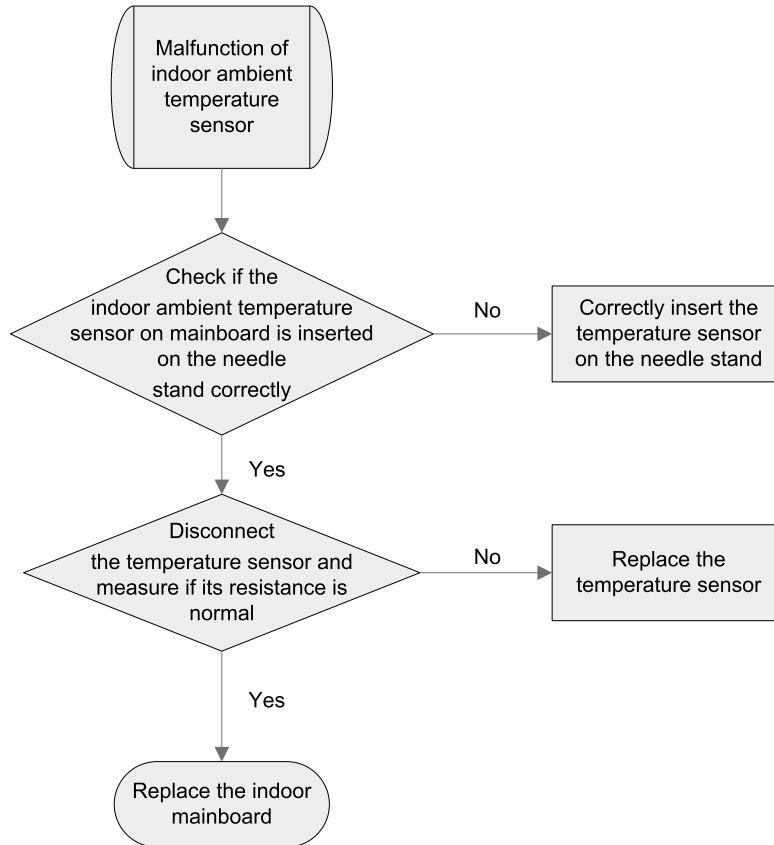

◆ F1 Malfunction of Evaporator Temperature Sensor

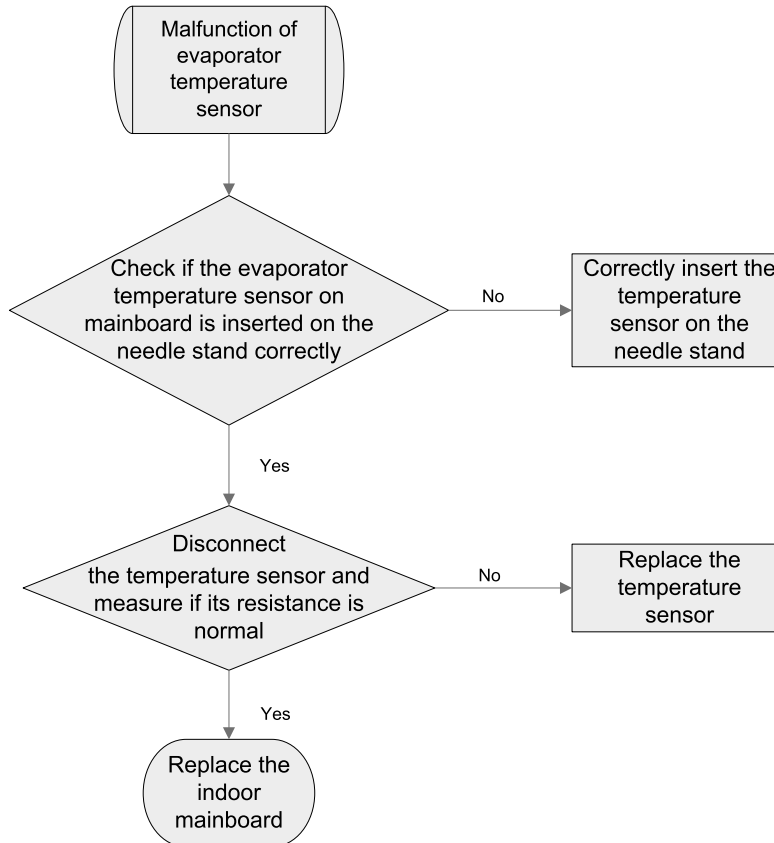

◆ F2 Malfunction of Condenser Temperature Sensor

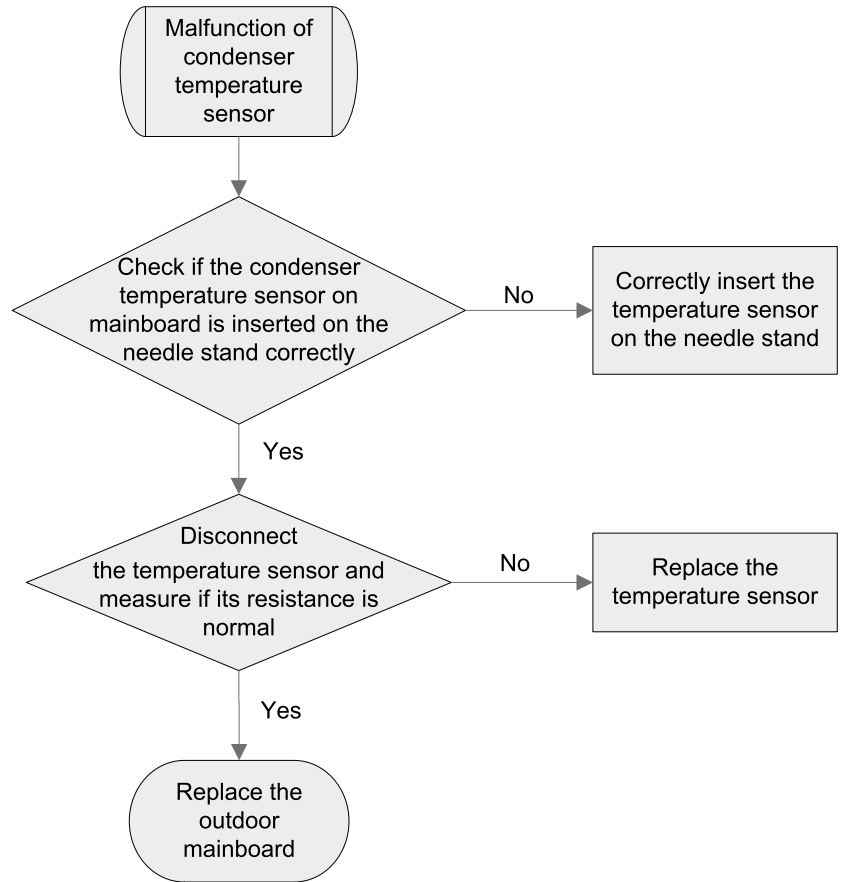

◆ F3 Malfunction of Outdoor Ambient Temperature Sensor

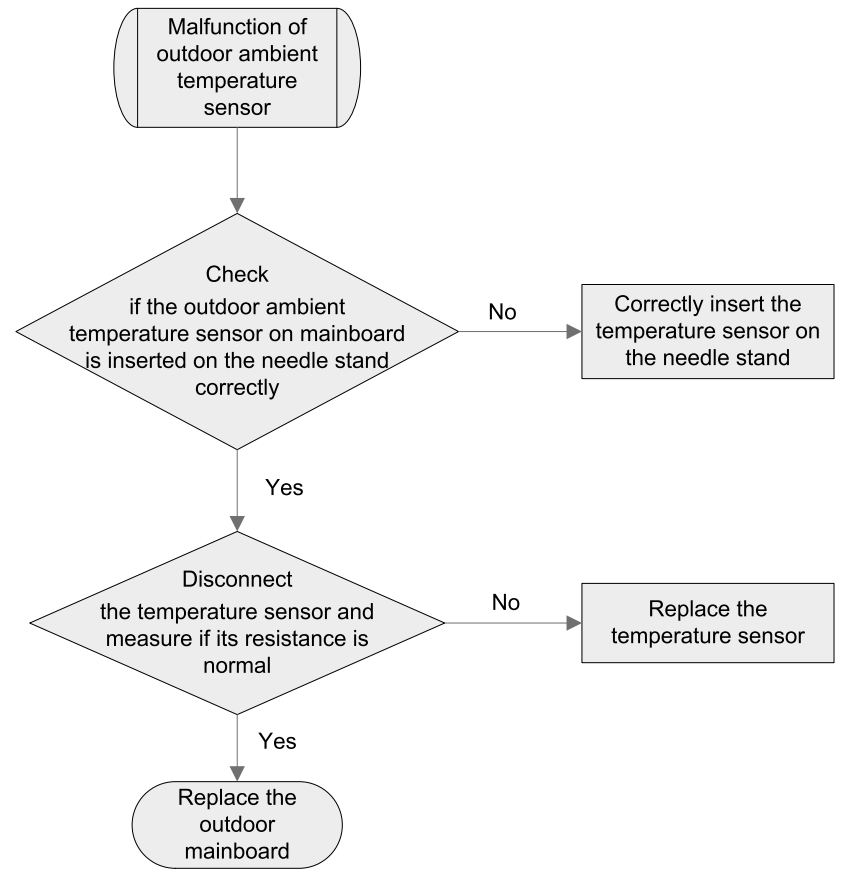

◆ F4 Malfunction of Discharge Temperature Sensor

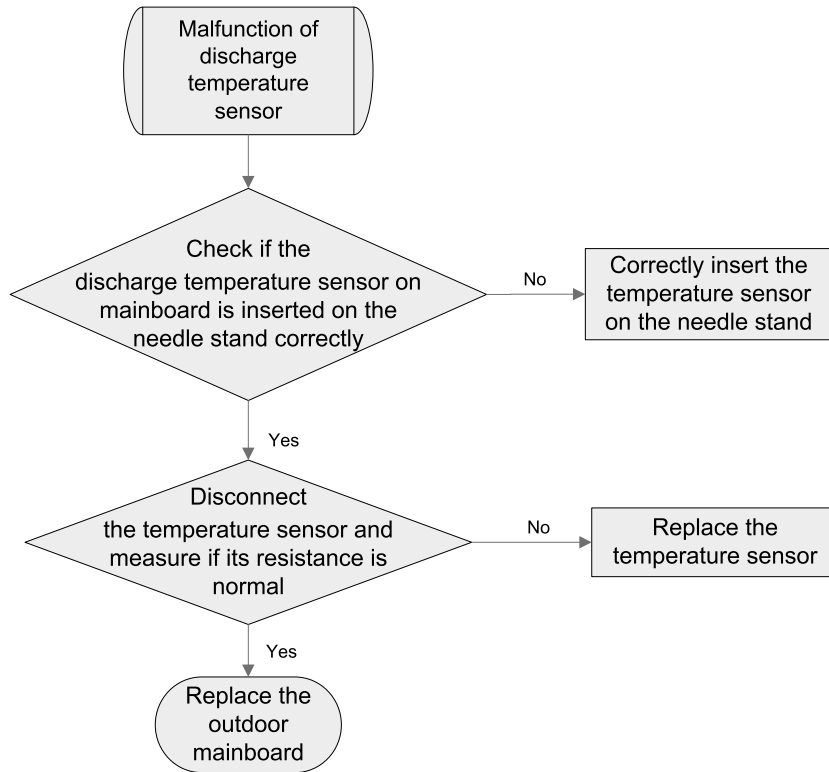

◆ F5 Malfunction of Wired Controller Temperature Sensor

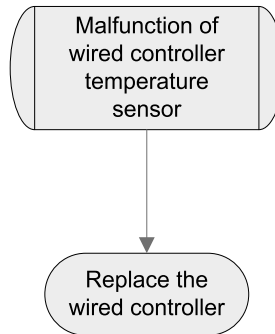

◆ F6 Condenser Mid-tube Thermistor Error

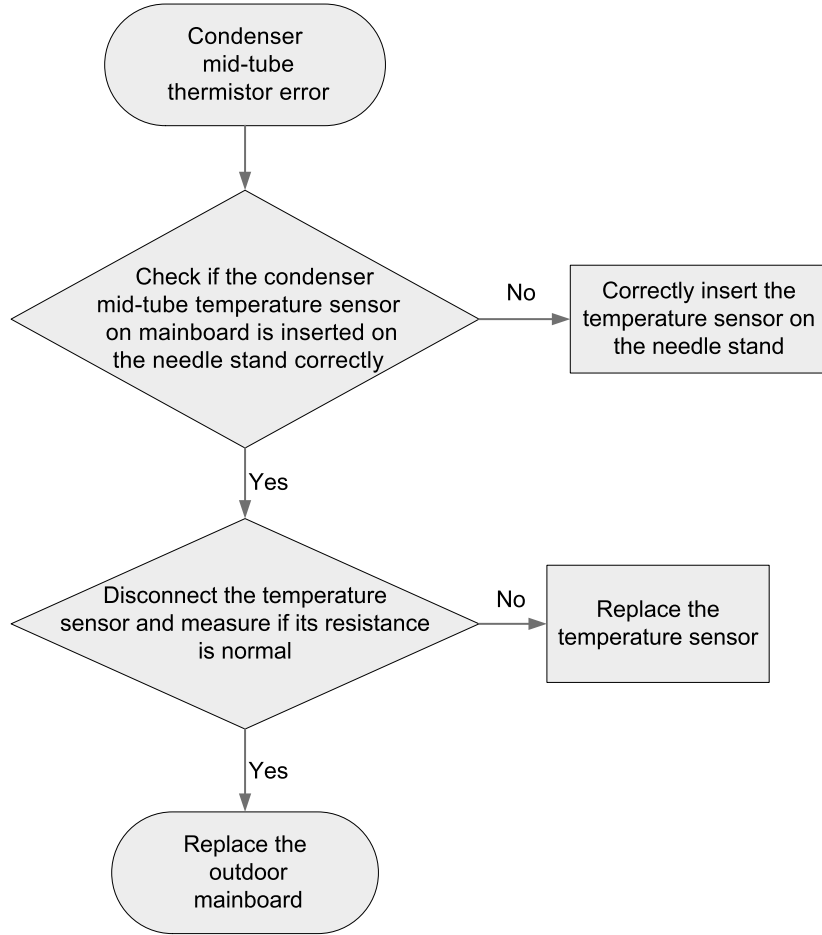

◆ H6 Malfunction of Outdoor Fan Motor

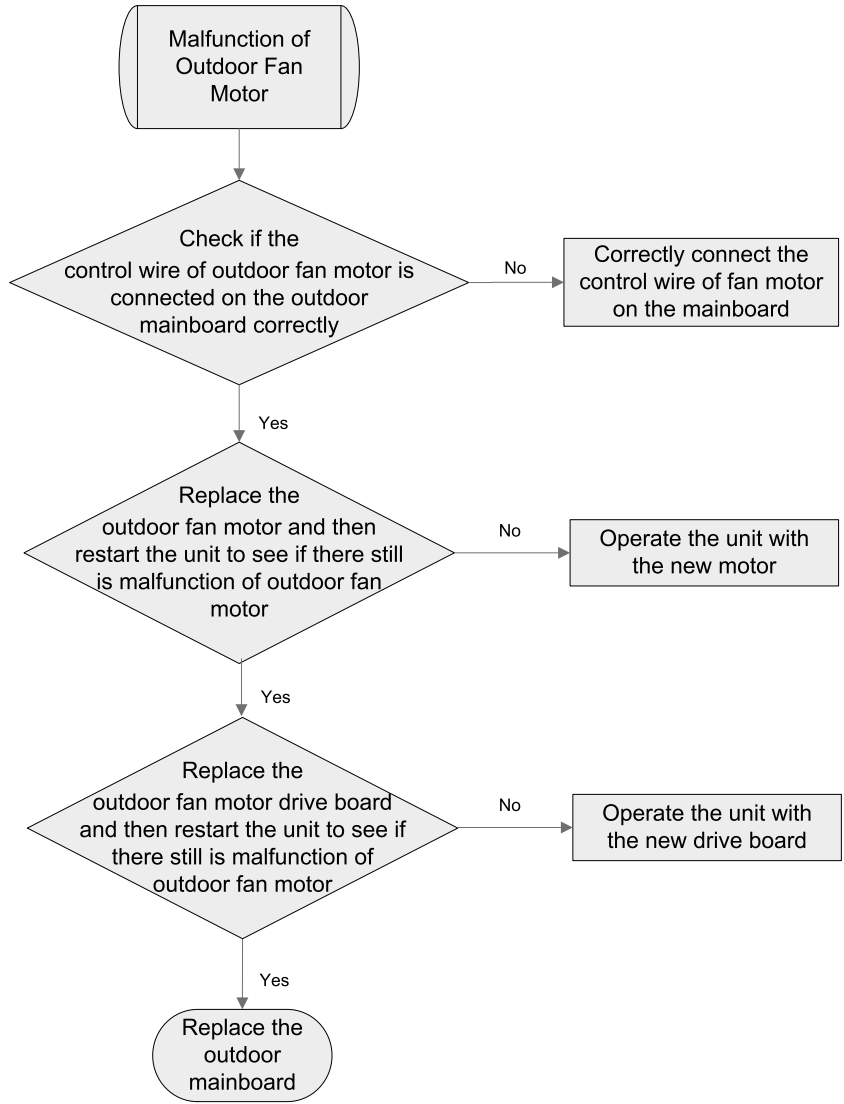

◆ E8 Malfunction of Indoor Fan Motor

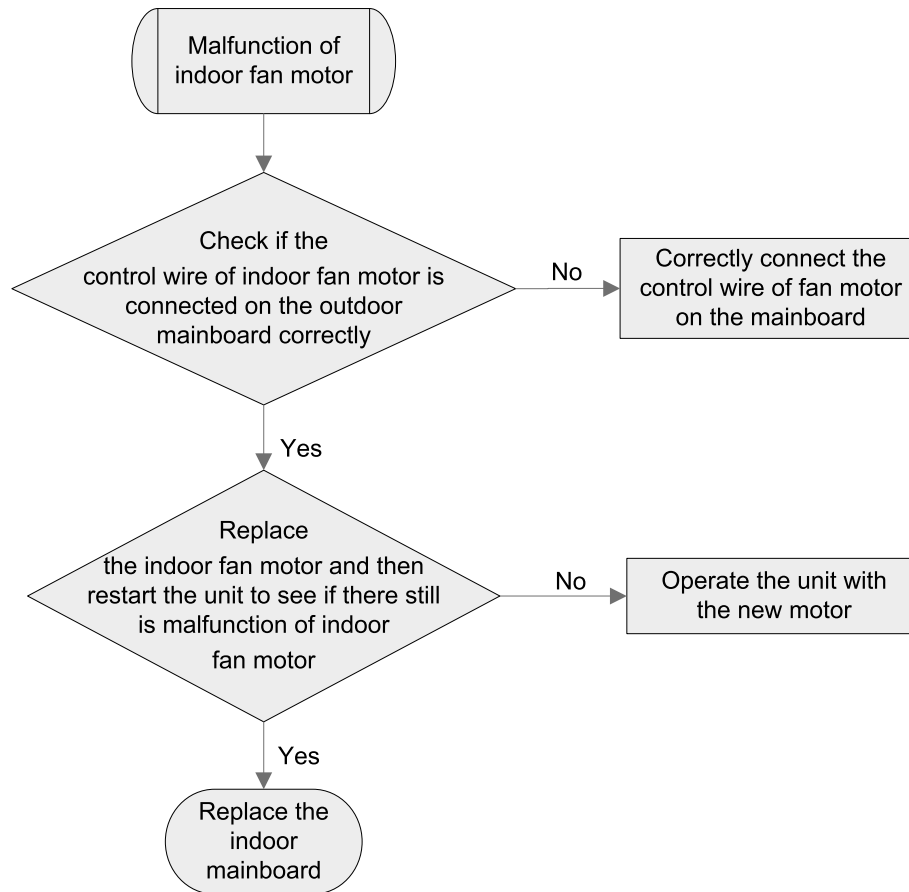
**2.2 TROUBLESHOOTING FLOW CHART OF DRIVE MALFUNCTION**

- ◆ P0 Drive module reset.
- ◆ P7 IPM temperature sensor error.
- ◆ PA AC current protection (input side).
- ◆ PC Current sense circuit error.

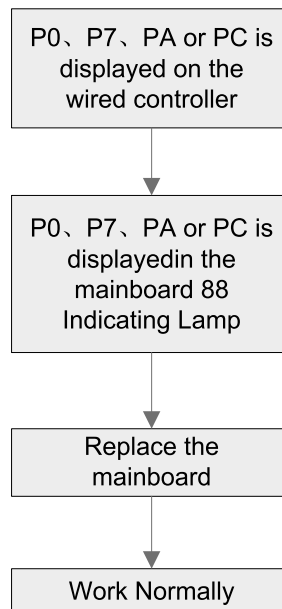

- ◆ PH DC busbar over-voltage protection
- ◆ PL DC busbar under-voltage protection

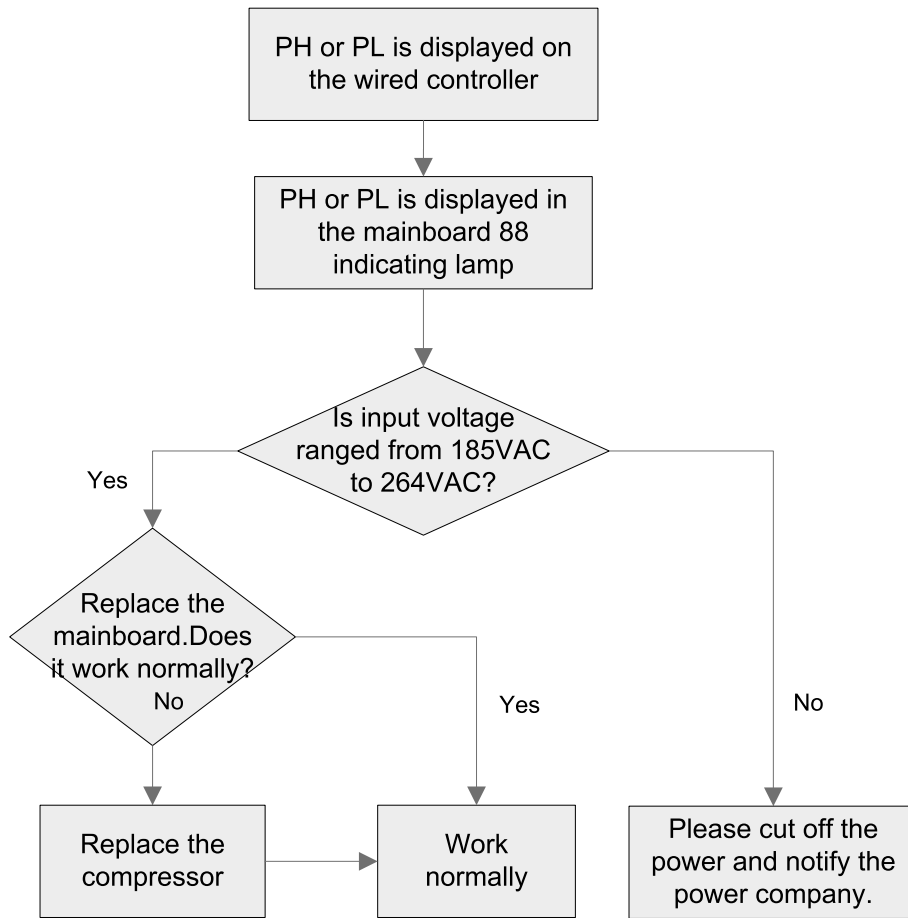

- ◆ P6 Drive-to-main-control communication error
- ◆ LC Compressor Startup Failure

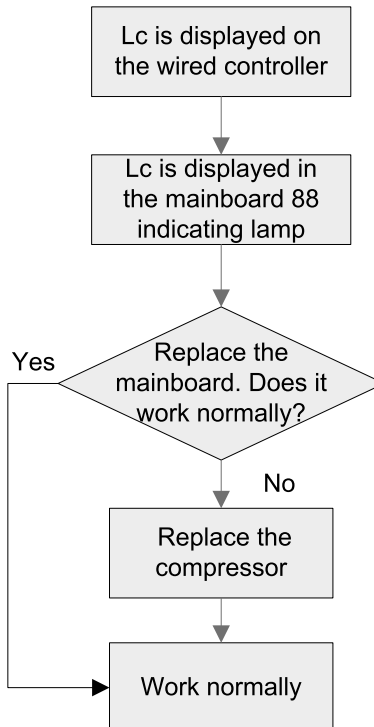

- ◆ P5 Compressor current protection
- ◆ H7 Compressor motor desynchronizing
- ◆ H5 IPM protection
- ◆ Ld Phase loss

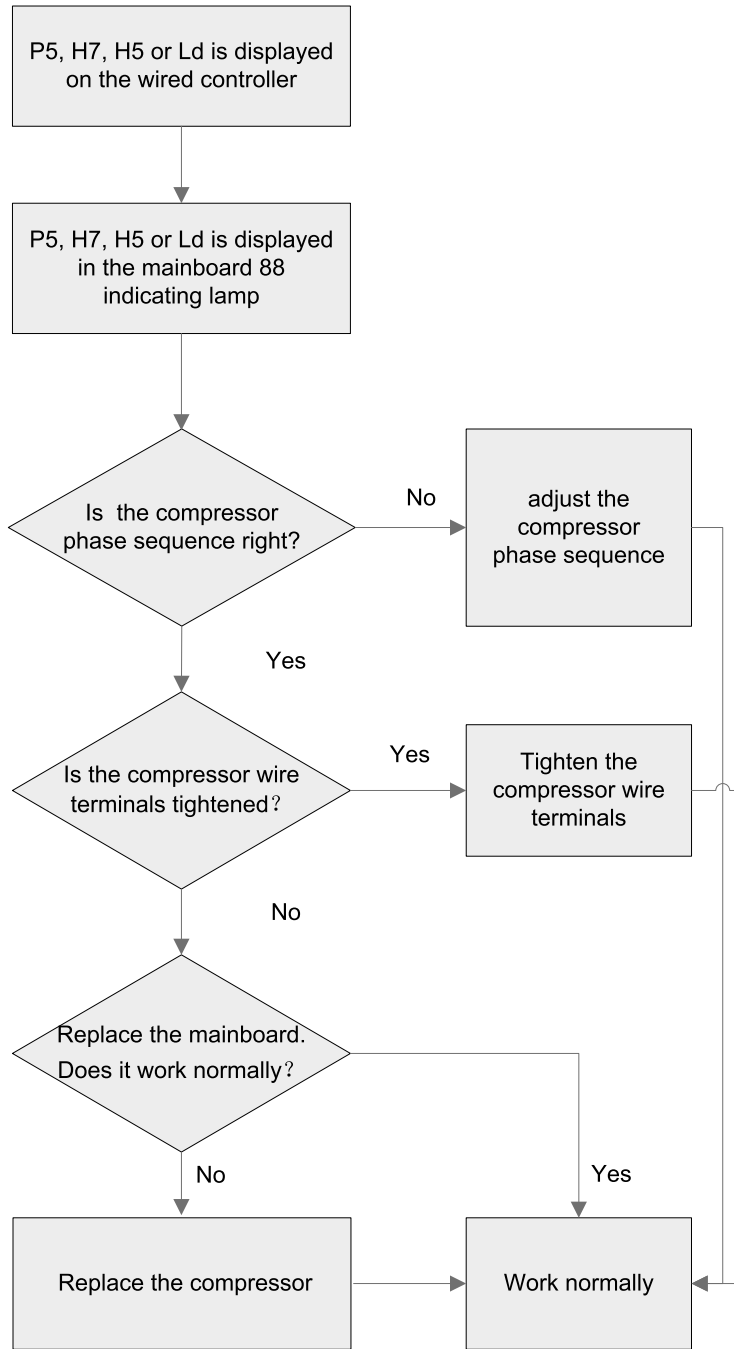

◆ ee driving board chip error

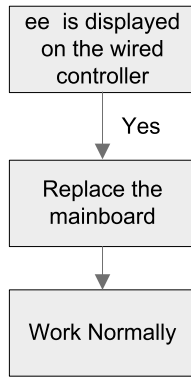

◆ H6 DC fan error

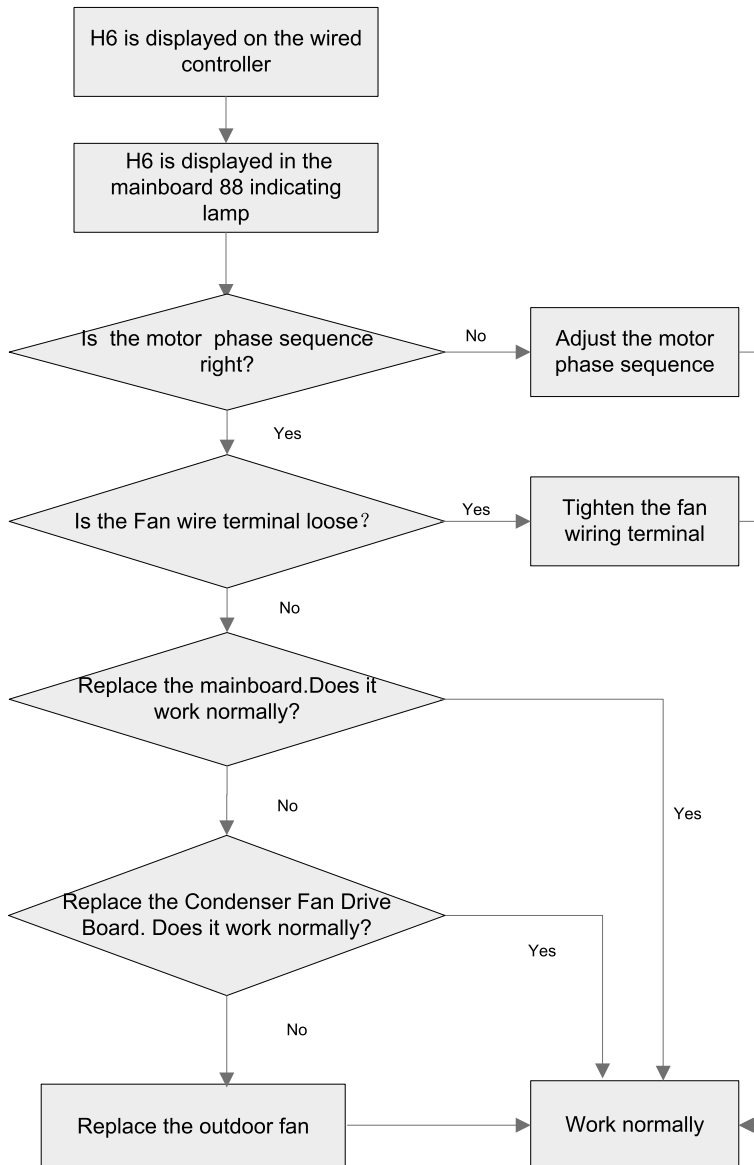

3 WIRING DIAGRAM

The actual wiring should always refer to the wiring diagram of the unit.

Model: GK-H02TC/NaA-T(U),GK-H03TC/NaA-T(U),GK-H04TC/NaA-T(U),GK-H05TC/NaA-T(U)

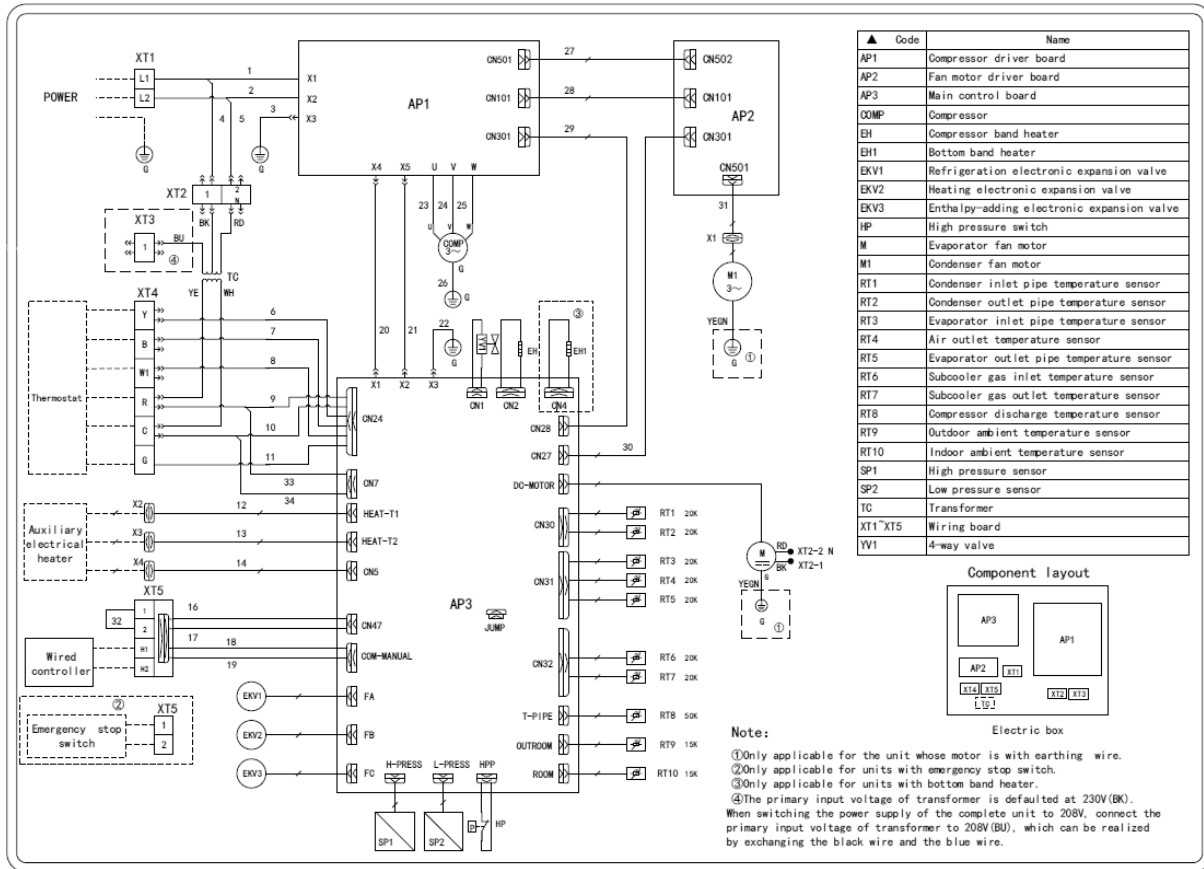

NOTE: Above data is subject to change without notice.

4 DISASSEMBLY AND ASSEMBLY PROCEDURE OF MAIN PARTS

4.1 Model: GK-H02TC/NaA-T(U),GK-H03TC/NaA-T(U)

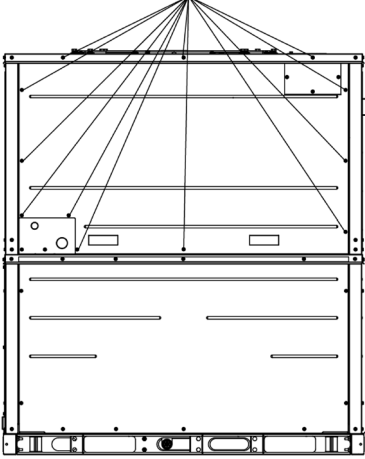
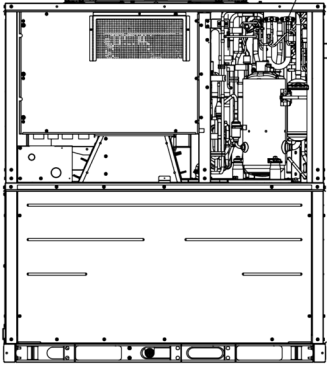
Disassembly and Assembly of Compressor		
Remark: Make sure there isn't any refrigerant in pipe system and the power supply is cut off before removal of the compressor.		
Step	Illustration	Handling Instruction
1. Open the front-panel.	<p style="text-align: center;">Screws</p> 	<ul style="list-style-type: none"> ● Unscrew the bolts (indicated by arrows).
2. Disconnect the power cord and condenser fan motor wires.	/	<ul style="list-style-type: none"> ● Disconnect the power cord and condenser fan motor wires after remove the side plate. <p>NOTE: Earmark the colour of wire corresponding to the terminal when removing the wire to avoid mistakes when renewing wire connection.</p>
3. Recover refrigerant in the system.	<p style="text-align: center;">Nozzells</p> 	<ul style="list-style-type: none"> ● Connect vacuum recovery tank with nozzle for adding freon for recovery of refrigerant. <p>NOTE: Recovery work must be complete because refrigerant is badly hurtful to environment and animals.</p>

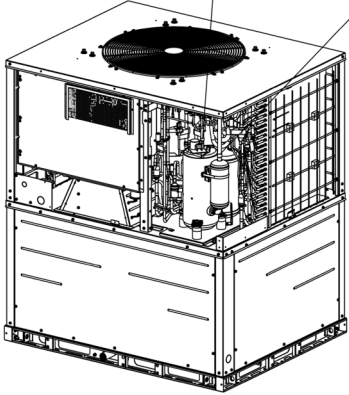
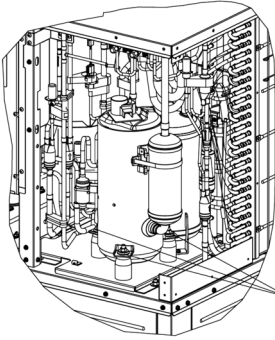
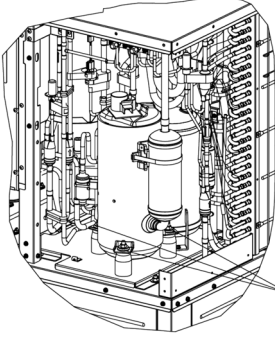
Disassembly and Assembly of Compressor		
Remark: Make sure there isn't any refrigerant in pipe system and the power supply is cut off before removal of the compressor.		
Step	Illustration	Handling Instruction
4. Remove the suction and discharge pipes.	 <p>Discharge pipe Suction pipe</p>	<ul style="list-style-type: none"> ● Heat the connection pipes indicated by arrows with fired heater and then draw out them. <p>NOTE: Pay attention to things around to avoid burning out.</p>
5. Remove the compressor from the chassis.	 <p>Nuts</p>	<ul style="list-style-type: none"> ● Unscrew the nuts on compressor base with a wrench and then remove compressor from the base. <p>NOTE: Keep compressor level and vertically out. Never invert it.</p>
6. Install a new compressor on the chassis.	 <p>Nuts</p>	<ul style="list-style-type: none"> ● Put the new compressor on the chassis as the direction during removing, and then screw down fixing nut on compressor base with a wrench. <p>NOTE: Keep compressor level and vertically on to the base. Never incline or invert it.</p>

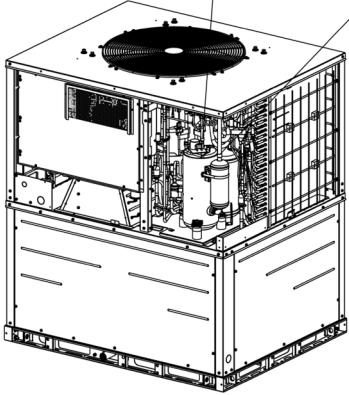
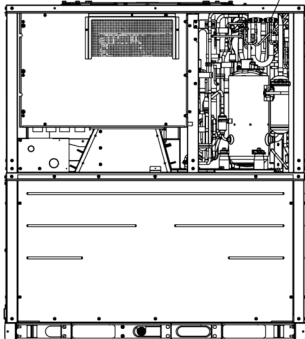
Disassembly and Assembly of Compressor		
Remark: Make sure there isn't any refrigerant in pipe system and the power supply is cut off before removal of the compressor.		
Step	Illustration	Handling Instruction
<p>7. Connect the suction and discharge pipes of the compressor with system pipes.</p>	<p style="text-align: center;">Discharge pipe Suction pipe</p> 	<ul style="list-style-type: none"> ● Heat the connection pipes indicated by arrows and then weld them with unit pipes together. <p>NOTE: Pay attention to things around to avoid burning out.</p>
<p>8. Reconnect power cord of compressor.</p>	<p>/</p>	<ul style="list-style-type: none"> ● Reconnect the power cord into compressor according to the procedure of disconnecting power cord. The line connection must accord to the schematic diagram. <p>NOTE: The connection box of compressor must be re-covered to resisting water. All cable can not contact the pipe and moving parts such as fan.</p>
<p>9. Recharge refrigerant.</p>	<p style="text-align: center;">Nozzells</p> 	<ul style="list-style-type: none"> ● Connect refrigerant tank with nozzle of low pressure (indicated by the maker) for recharging refrigerant. <p>NOTE: Check the leak after finishing the connectionpipes. Charge amount should be consistent with nameplate.</p>

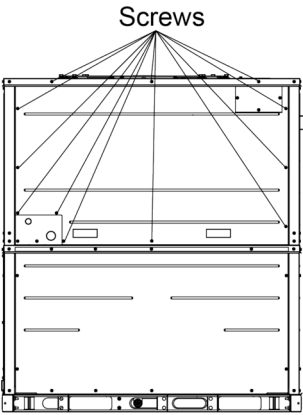
Disassembly and Assembly of Compressor		
Remark: Make sure there isn't any refrigerant in pipe system and the power supply is cut off before removal of the compressor.		
Step	Illustration	Handling Instruction
10. Close the front-panel.		<ul style="list-style-type: none"> ● Tighten the bolts.

NOTE: Above diagrams may be different from actual model.

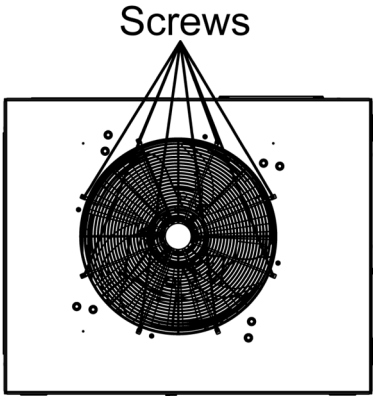
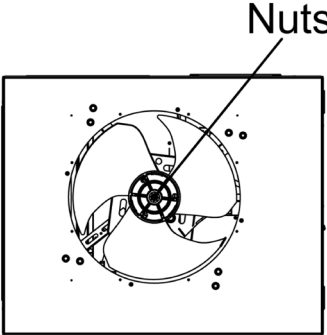
Disassembly and Assembly of Condenser Fan Motor		
Remark: Make sure that the unit is stopped running and power supply is cut off before removal of the motor.		
Step	Illustration	Handling Instruction
1. Disconnect the electrical source wire.	/	<ul style="list-style-type: none"> ● Disconnect all connection lines between condenser fan motor and elements in electric box. <p>NOTE: Please refer to the schematic diagram which adhered on electric box for disconnection of connection lines of condenser fan motor.</p>
2. Remove the Rear Grill.		<ul style="list-style-type: none"> ● Unscrew the screws fixing rear Grill(indicated by arrows) to remove it.
3. Remove the fan.		<ul style="list-style-type: none"> ● Unscrew the screw (indicated by the arrow) fixing fan to remove the fan. <p>NOTE: Fix the fan when unscrew the holding bolt to avoid fan from rotating and thereby injury to people is caused.</p>

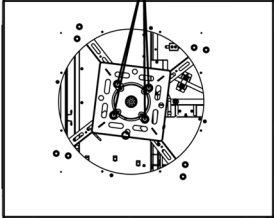
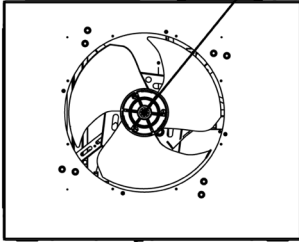
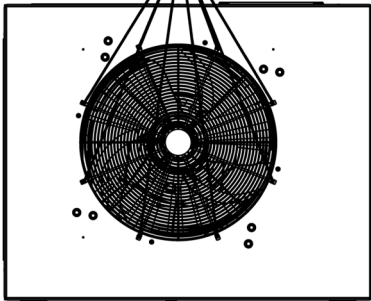
Disassembly and Assembly of Condenser Fan Motor		
Remark: Make sure that the unit is stopped running and power supply is cut off before removal of the motor.		
Step	Illustration	Handling Instruction
4. Remove the motor from the bracket.	/	<ul style="list-style-type: none"> Remove the holding bolt of motor firstly and then remove motor from bracket. <p>NOTE: Loosen power cord fixed by bundles before removing motor.</p>
5. Fix the new motor on to the bracket.	<p>Nuts</p> 	<ul style="list-style-type: none"> Put the repaired or replaced motor onto bracket as the direction during removing. Then screw down the holding bolt with a wrench. <p>NOTE: Please keep the motor level and vertical during installation. After that, fix the power cord with bundles at original locations.</p>
6. Install and fix fan blade.	<p>Nuts</p> 	<ul style="list-style-type: none"> Re-install fan blade and screw down the holding bolt indicated by the arrow with a wrench <p>NOTE: Moment of force should be within 8-12N during screwing down bolt. After that, please charge glue into gap between bolt and hole to avoid loose of it.</p>
7. Re-install the Rear Grill.	<p>Screws</p> 	<ul style="list-style-type: none"> Put the rear Grill back and tighten the screws.
8. Re-connect power cord.	/	<ul style="list-style-type: none"> Re-connect power cord according to circuit mark adhered on electric box. <p>NOTE: After connection, arrange leading wires and refix them with bundles at original locations. Close the cover plate of electric box hermetically. All cable can not contact the pipe and moving parts such as fan.</p>

NOTE: Above diagrams may be different from actual model.

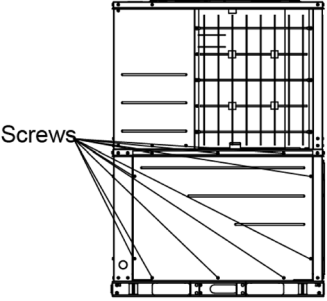
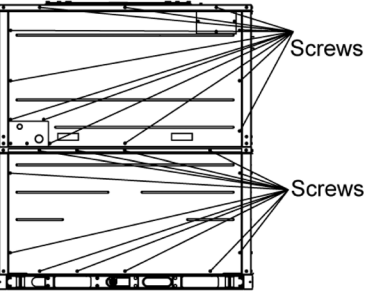
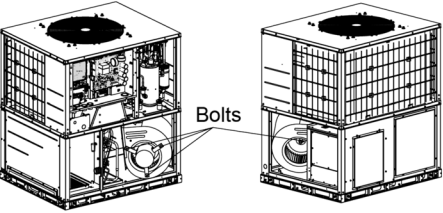
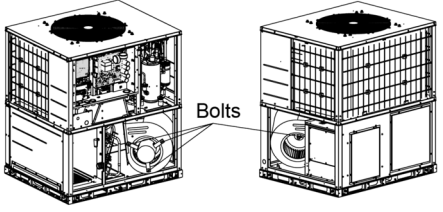
Disassembly and Assembly of Supply Blower Motor		
Remark: Make sure that the unit is stopped running and power supply is cut off before removal of the motor.		
Step	Illustration	Handling Instruction
1. Remove the side plate.		<ul style="list-style-type: none"> ● Unscrew the screws fixing side plate (indicated by arrows) to remove it.
2. Remove the front plate.		<ul style="list-style-type: none"> ● Unscrew the screws fixing cover plate (indicated by arrows) to remove it.
3. Disconnect all connection lines.	/	<ul style="list-style-type: none"> ● Disconnect all connection lines between motor and elements in electric box. <p>NOTE: Please refer to the schematic diagram which adhered on electric box for disconnection of connection lines of supply blower motor.</p>
4. Remove the motor.		<ul style="list-style-type: none"> ● Unscrew the nuts (indicated by arrows) to loosen the connection between motor and bracket.
5. Re-install the motor.		<ul style="list-style-type: none"> ● Re-assemble repaired or replaced motor. Installation direction is the same as that during disassembly. Then screw down the holding bolts with a wrench.

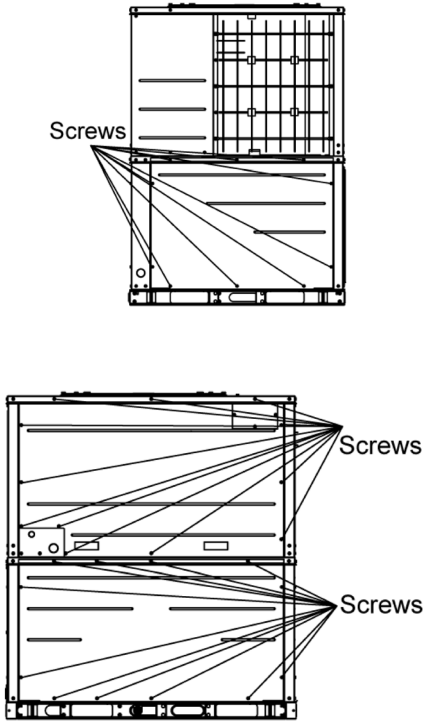
Disassembly and Assembly of Supply Blower Motor		
Remark: Make sure that the unit is stopped running and power supply is cut off before removal of the motor.		
Step	Illustration	Handling Instruction
<p>6. Re-connect power cord.</p>	<p style="text-align: center;">/</p>	<ul style="list-style-type: none"> ● Re-connect power cord according to wiring diagram adhered on electric box. <p>NOTE: After connection, arrange leading wires and refix them with bundles at original locations. All cable can not contact the pipe and moving parts such as fan. Close the cover plate of electric box hermetically.</p>
<p>7. Re-install the side and front plate.</p>		<ul style="list-style-type: none"> ● Put pulleys onto shaft and then put taper sleeve. After that, cover the pulleys onto taper sleeve. Clockwise screw down the 2 bolts. <p>NOTE: The sleeve has taper, so pulleys must be installed first. Ensure the coplanarity of pulleys, and adjust the tightness level of belt.</p>

NOTE: Above diagrams may be different from actual model.

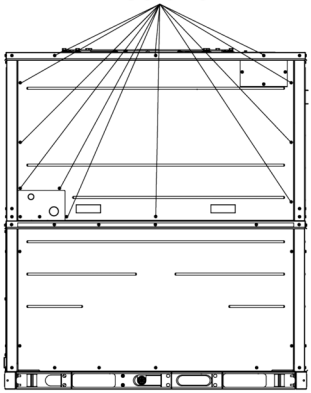
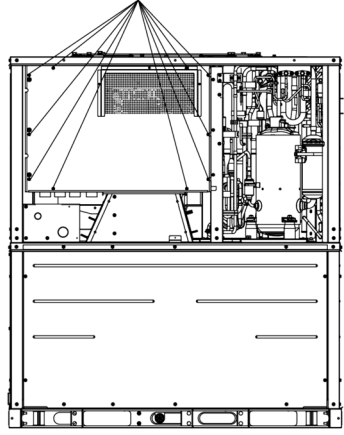
Disassembly and Assembly of Electric Box		
Remark: Make sure that the unit is stopped running and power supply is cut off before removal.		
Step	Illustration	Handling Instruction
1. Take down the front plate.	<p style="text-align: center;">Screws</p> 	<ul style="list-style-type: none"> ● Unscrew the screws fixing front plate. Lift the handles, slightly pulling it outwards and downwards to remove the side plate.
2. Disconnect the power cord.	/	<ul style="list-style-type: none"> ● Pull out power cord or disconnect the power cord after unscrewing the screws. <p>NOTE: Earmark the colour of wire corresponding to the terminal when removing the wire to avoid mistakes when renewing wire connection.</p>
3. Remove the electric box cover.	<p style="text-align: center;">Screws</p> 	<ul style="list-style-type: none"> ● Unscrew the screws fixing cover (indicated by the arrows). Then remove the cover.
4. Disconnect all connection lines.	/	<ul style="list-style-type: none"> ● Disconnect all connection lines between exterior electric component and elements in electric box. <p>NOTE: Please refer to the schematic diagram which adhered on electric box for disconnection of connection lines of motor.</p>

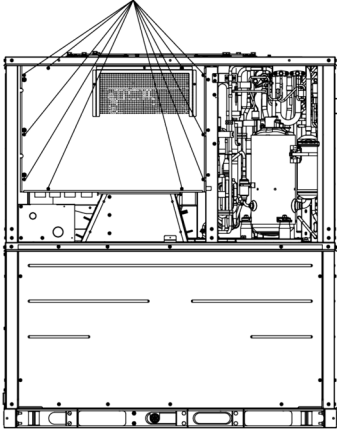
Disassembly and Assembly of Electric Box		
Remark: Make sure that the unit is stopped running and power supply is cut off before removal.		
Step	Illustration	Handling Instruction
5. Remove the main board.	/	<ul style="list-style-type: none"> ● Unscrew the screws (indicated by the arrows),and then take down the main board. <p>NOTE: Power cord may be fixed by bundles, so loose the bundles before removing the main board.</p>
6. Re-install the main board.	/	<ul style="list-style-type: none"> ● Put the main board back and tighten the screws. Then reconnect all connection lines that had been take down, and refix the Power cord with bundles at original locations. <p>NOTE: The line connection must accord to the schematic diagram. All cable can not contact the pipe and moving parts such as fan.</p>
7. Re-connect power cord.	/	<ul style="list-style-type: none"> ● Re-connect power cord according to wiring diagram adhered on electric box. <p>NOTE: After connection, arrange leading wires and refix them with bundles at original locations. All cable can not contact the pipe and moving parts such as fan. Close the cover plate of electric box hermetically.</p>
8. Re-install the electric box cover.	<p style="text-align: center;">Screws</p> 	<ul style="list-style-type: none"> ● Screw the screws fixing cover (indicated by the arrows).

Disassembly and Assembly of Electric Box		
Remark: Make sure that the unit is stopped running and power supply is cut off before removal.		
Step	Illustration	Handling Instruction
9. Re-install the front plate.	<p style="text-align: center;">Screws</p>	<ul style="list-style-type: none"> ● Put the side plate back and tighten the screws.

NOTE: Above diagrams may be different from actual model.

4.2 Model: GK-H04TC/NaA-T(U),GK-H05TC/NaA-T(U)

Disassembly and Assembly of Compressor		
Remark: Make sure there isn't any refrigerant in pipe system and the power supply is cut off before removal of the compressor.		
Step	Illustration	Handling Instruction
1. Open the front-panel.	<p style="text-align: center;">Screws</p>	<ul style="list-style-type: none"> ● Unscrew the bolts (indicated by arrows).
2. Disconnect the power cord and condenser fan motor wires.	/	<ul style="list-style-type: none"> ● Disconnect the power cord and condenser fan motor wires after remove the side plate. <p>NOTE: Earmark the colour of wire corresponding to the terminal when removing the wire to avoid mistakes when renewing wire connection.</p>

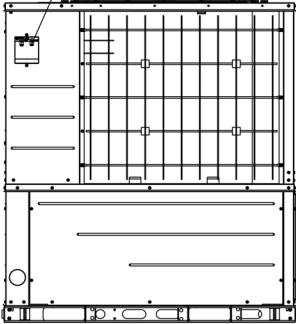
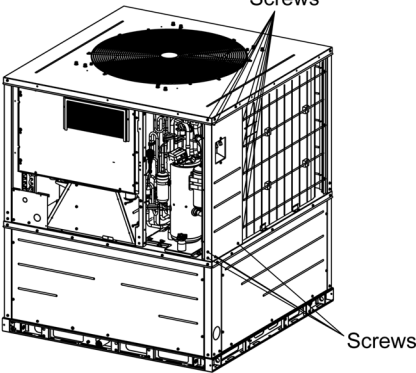
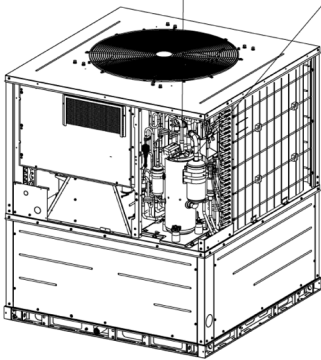
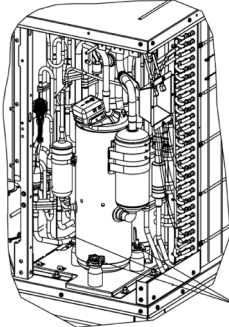
Disassembly and Assembly of Compressor		
Remark: Make sure there isn't any refrigerant in pipe system and the power supply is cut off before removal of the compressor.		
Step	Illustration	Handling Instruction
3. Recover refrigerant in the system.	<p>Nozzells</p> 	<ul style="list-style-type: none"> ● Connect vacuum recovery tank with nozzle for adding freon for recovery of refrigerant. <p>NOTE: Recovery work must be complete because refrigerant is badly hurtful to environment and animals.</p>
4. Open the side-panel.	<p>Screws</p>  <p>Screws</p>	<ul style="list-style-type: none"> ● Unscrew the bolts (indicated by arrows).
5. Remove the suction and discharge pipes.	<p>Discharge pipe Suction pipe</p> 	<ul style="list-style-type: none"> ● Heat the connection pipes indicated by arrows with fired heater and then draw out them. <p>NOTE: Pay attention to things around to avoid burning out.</p>
6. Remove the compressor from the chassis.	 <p>Nuts</p>	<ul style="list-style-type: none"> ● Unscrew the nuts on compressor base with a wrench and then remove compressor from the base. <p>NOTE: Keep compressor level and vertically out. Never invert it.</p>

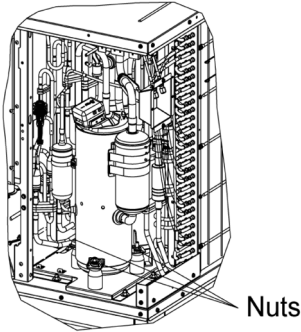
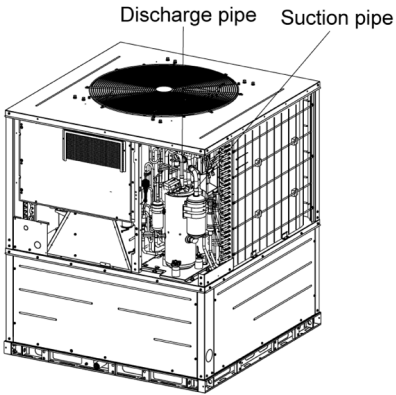
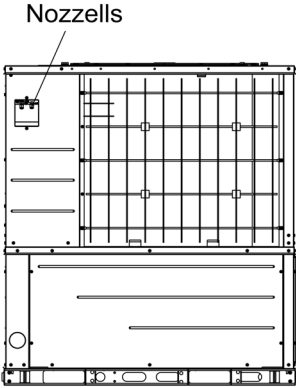
Disassembly and Assembly of Compressor		
Remark: Make sure there isn't any refrigerant in pipe system and the power supply is cut off before removal of the compressor.		
Step	Illustration	Handling Instruction
7. Install a new compressor on the chassis.		<ul style="list-style-type: none"> Put the new compressor on the chassis as the direction during removing, and then screw down fixing nut on compressor base with a wrench. <p>NOTE: Keep compressor level and vertically on to the base. Never incline or invert it.</p>
8. Connect the suction and discharge pipes of the compressor with system pipes.		<ul style="list-style-type: none"> Heat the connection pipes indicated by arrows and then weld them with unit pipes together. <p>NOTE: Pay attention to things around to avoid burning out.</p>
9. Reconnect power cord of compressor.	/	<ul style="list-style-type: none"> Reconnect the power cord into compressor according to the procedure of disconnecting power cord. The line connection must accord to the schematic diagram. <p>NOTE: The connection box of compressor must be re-covered to resisting water. All cable can not contact the pipe and moving parts such as fan.</p>
10. Recharge refrigerant.		<ul style="list-style-type: none"> Connect refrigerant tank with nozzle of low pressure (indicated by the maker) for recharging refrigerant. <p>NOTE: Check the leak after finishing the connection pipes. Charge amount should be consistent with nameplate.</p>

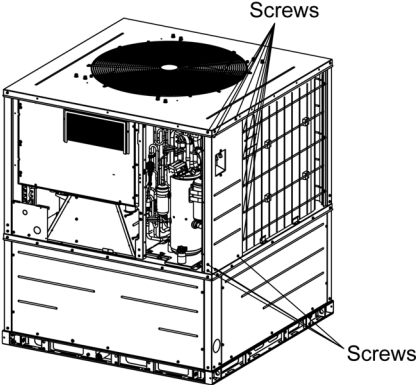
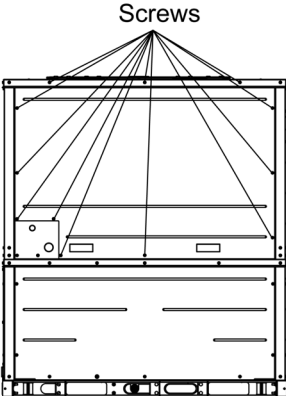
Disassembly and Assembly of Compressor		
Remark: Make sure there isn't any refrigerant in pipe system and the power supply is cut off before removal of the compressor.		
Step	Illustration	Handling Instruction
11. Close the side-panel.		<ul style="list-style-type: none"> ● Tighten the bolts.
12. Close the front-panel.		<ul style="list-style-type: none"> ● Tighten the bolts.

NOTE: Above diagrams may be different from actual model.

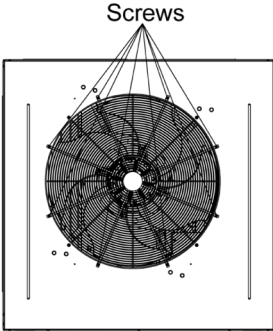
Disassembly and Assembly of Condenser Fan Motor		
Remark: Make sure that the unit is stopped running and power supply is cut off before removal of the motor.		
Step	Illustration	Handling Instruction
1. Disconnect the electrical source wire.	/	<ul style="list-style-type: none"> ● Disconnect all connection lines between condenser fan motor and elements in electric box. <p>NOTE: Please refer to the schematic diagram which adhered on electric box for disconnection of connection lines of condenser fan motor.</p>
2. Remove the Rear Grill.		<ul style="list-style-type: none"> ● Unscrew the screws fixing rear Grill (indicated by arrows) to remove it.

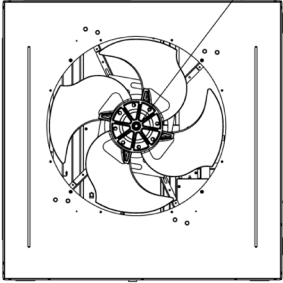
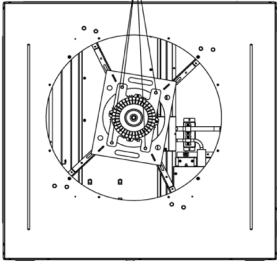
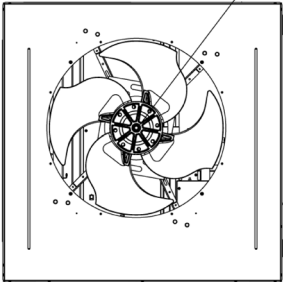
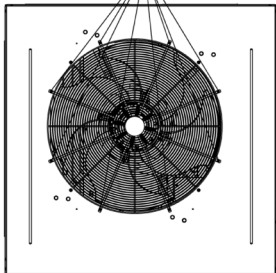
Disassembly and Assembly of Condenser Fan Motor		
Remark: Make sure that the unit is stopped running and power supply is cut off before removal of the motor.		
Step	Illustration	Handling Instruction
3. Remove the fan.		<ul style="list-style-type: none"> ● Unscrew the screw (indicated by the arrow) fixing fan to remove the fan. <p>NOTE: Fix the fan when unscrew the holding bolt to avoid fan from rotating and thereby injury to people is caused.</p>
4. Remove the motor from the bracket.	/	<ul style="list-style-type: none"> ● Remove the holding bolt of motor firstly and then remove motor from bracket. <p>NOTE: Loosen power cord fixed by bundles before removing motor.</p>
5. Fix the new motor on to the bracket.		<ul style="list-style-type: none"> ● Put the repaired or replaced motor onto bracket as the direction during removing. Then screw down the holding bolt with a wrench. <p>NOTE: Please keep the motor level and vertical during installation. After that, fix the power cord with bundles at original locations.</p>
6. Install and fix fan blade.		<ul style="list-style-type: none"> ● Re-install fan blade and screw down the holding bolt indicated by the arrow with a wrench <p>NOTE: Moment of force should be within 8-12N during screwing down bolt. After that, please charge glue into gap between bolt and hole to avoid loose of it.</p>
7. Re-install the Rear Grill.		<ul style="list-style-type: none"> ● Put the cover rear Grill and tighten the screws.

Disassembly and Assembly of Condenser Fan Motor		
Remark: Make sure that the unit is stopped running and power supply is cut off before removal of the motor.		
Step	Illustration	Handling Instruction
8. Re-connect power cord.	/	<ul style="list-style-type: none"> ● Re-connect power cord according to circuit mark adhered on electric box. <p>NOTE: After connection, arrange leading wires and refix them with bundles at original locations. Close the cover plate of electric box hermetically. All cable can not contact the pipe and moving parts such as fan.</p>

NOTE: Above diagrams may be different from actual model.

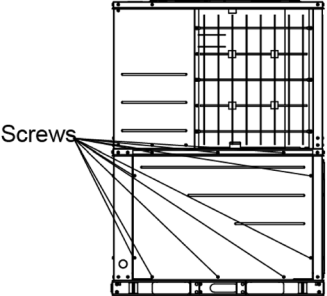
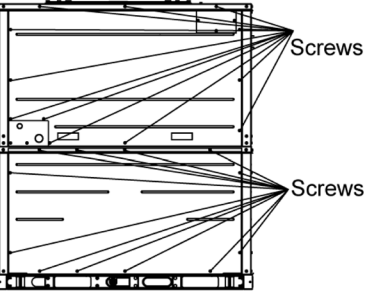
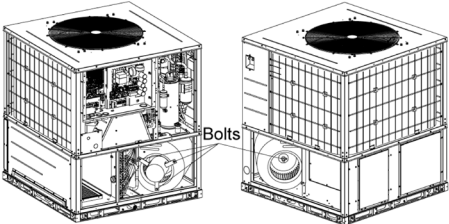
Disassembly and Assembly of Supply Blower Motor		
Remark: Make sure that the unit is stopped running and power supply is cut off before removal of the motor.		
Step	Illustration	Handling Instruction
1. Remove the side plate.		<ul style="list-style-type: none"> ● Unscrew the screws fixing side plate (indicated by arrows) to remove it.
2. Remove the front plate.		<ul style="list-style-type: none"> ● Unscrew the screws fixing cover plate (indicated by arrows) to remove it.
3. Disconnect all connection lines.	/	<ul style="list-style-type: none"> ● Disconnect all connection lines between motor and elements in electric box. <p>NOTE: Please refer to the schematic diagram which adhered on electric box for disconnection of connection lines of supply blower motor.</p>
4. Remove the motor.		<ul style="list-style-type: none"> ● Unscrew the nuts (indicated by arrows) to loosen the connection between motor and bracket.

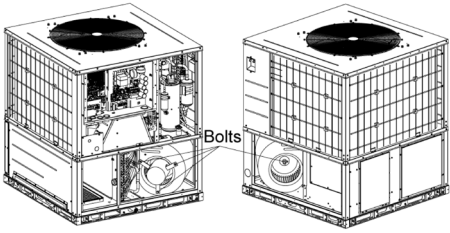
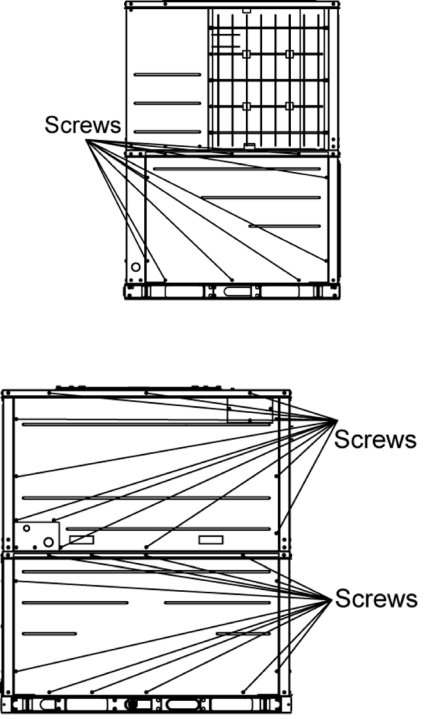
Disassembly and Assembly of Supply Blower Motor		
Remark: Make sure that the unit is stopped running and power supply is cut off before removal of the motor.		
Step	Illustration	Handling Instruction
5. Re-install the motor.		<ul style="list-style-type: none"> ● Re-assemble repaired or replaced motor. Installation direction is the same as that during disassembly. Then screw down the holding bolts with a wrench.
6. Re-connect power cord.	/	<ul style="list-style-type: none"> ● Re-connect power cord according to wiring diagram adhered on electric box. <p>NOTE: After connection, arrange leading wires and refix them with bundles at original locations. All cable can not contact the pipe and moving parts such as fan. Close the cover plate of electric box hermetically.</p>
7. Re-install the side and front plate.		<ul style="list-style-type: none"> ● Put pulleys onto shaft and then put taper sleeve. After that, cover the pulleys onto taper sleeve. Clockwise screw down the 2 bolts. <p>NOTE: The sleeve has taper, so pulleys must be installed first. Ensure the coplanarity of pulleys, and adjust the tightness level of belt.</p>

NOTE: Above diagrams may be different from actual model.

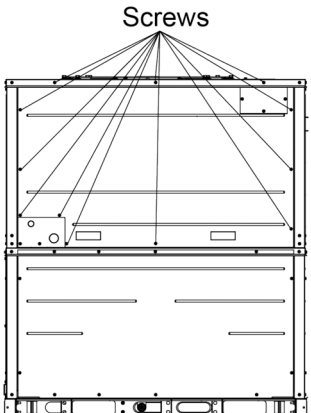
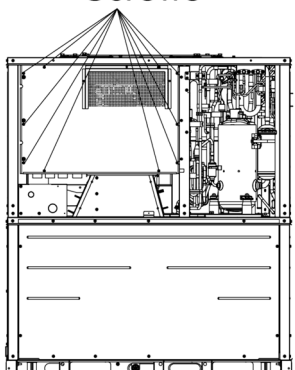
Disassembly and Assembly of Electric Box		
Remark: Make sure that the unit is stopped running and power supply is cut off before removal.		
Step	Illustration	Handling Instruction
1. Take down the front plate.	 <p style="text-align: center;">Screws</p>	<ul style="list-style-type: none"> ● Unscrew the screws fixing front plate. Lift the handles, slightly pulling it outwards and downwards to remove the side plate.
2. Disconnect the power cord.	/	<ul style="list-style-type: none"> ● Pull out power cord or disconnect the power cord after unscrewing the screws. <p>NOTE: Earmark the colour of wire corresponding to the terminal when removing the wire to avoid mistakes when renewing wire connection.</p>
3. Remove the electric box cover.	 <p style="text-align: center;">Screws</p>	<ul style="list-style-type: none"> ● Unscrew the screws fixing cover (indicated by the arrows).Then remove the cover.
4. Disconnect all connection lines.	/	<ul style="list-style-type: none"> ● Disconnect all connection lines between exterior electric component and elements in electric box. <p>NOTE: Please refer to the schematic diagram which adhered on electric box for disconnection of connection lines of motor.</p>
5. Remove the Main Board.	/	<ul style="list-style-type: none"> ● Unscrew the screws (indicated by the arrows),and then take down the Main Board. <p>NOTE: Power cord may be fixed by bundles, so loose the bundles before removing the main board.</p>

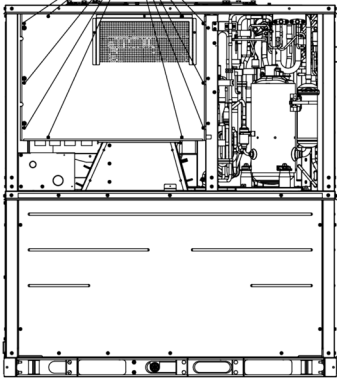
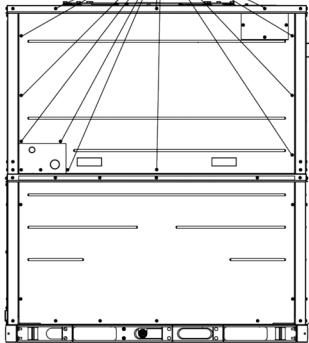
Disassembly and Assembly of Electric Box		
Remark: Make sure that the unit is stopped running and power supply is cut off before removal.		
Step	Illustration	Handling Instruction
6. Re-install the Main Board.	/	<ul style="list-style-type: none"> ● Put the Main Board back and tighten the screws. Then reconnect all connection lines that had been take down, and refix the Power cord with bundles at original locations. <p>NOTE: The line connection must accord to the schematic diagram. All cable can not contact the pipe and moving parts such as fan.</p>
7. Re-connect power cord.	/	<ul style="list-style-type: none"> ● Re-connect power cord according to wiring diagram adhered on electric box. <p>NOTE: After connection, arrange leading wires and refix them with bundles at original locations. All cable can not contact the pipe and moving parts such as fan. Close the cover plate of electric box hermetically.</p>
8. Re-install the electric box cover.	<p>Screws</p> 	<ul style="list-style-type: none"> ● Screw the screws fixing cover (indicated by the arrows).
9. Re-install the front plate.	<p>Screws</p> 	<ul style="list-style-type: none"> ● Put the side plate back and tighten the screws.

NOTE: Above diagrams may be different from actual model.

5 EXPLODED VIEWS AND SPARE PART LIST

5.1 Model: GK-H02TC/NaA-T(U),GK-H03TC/NaA-T(U)

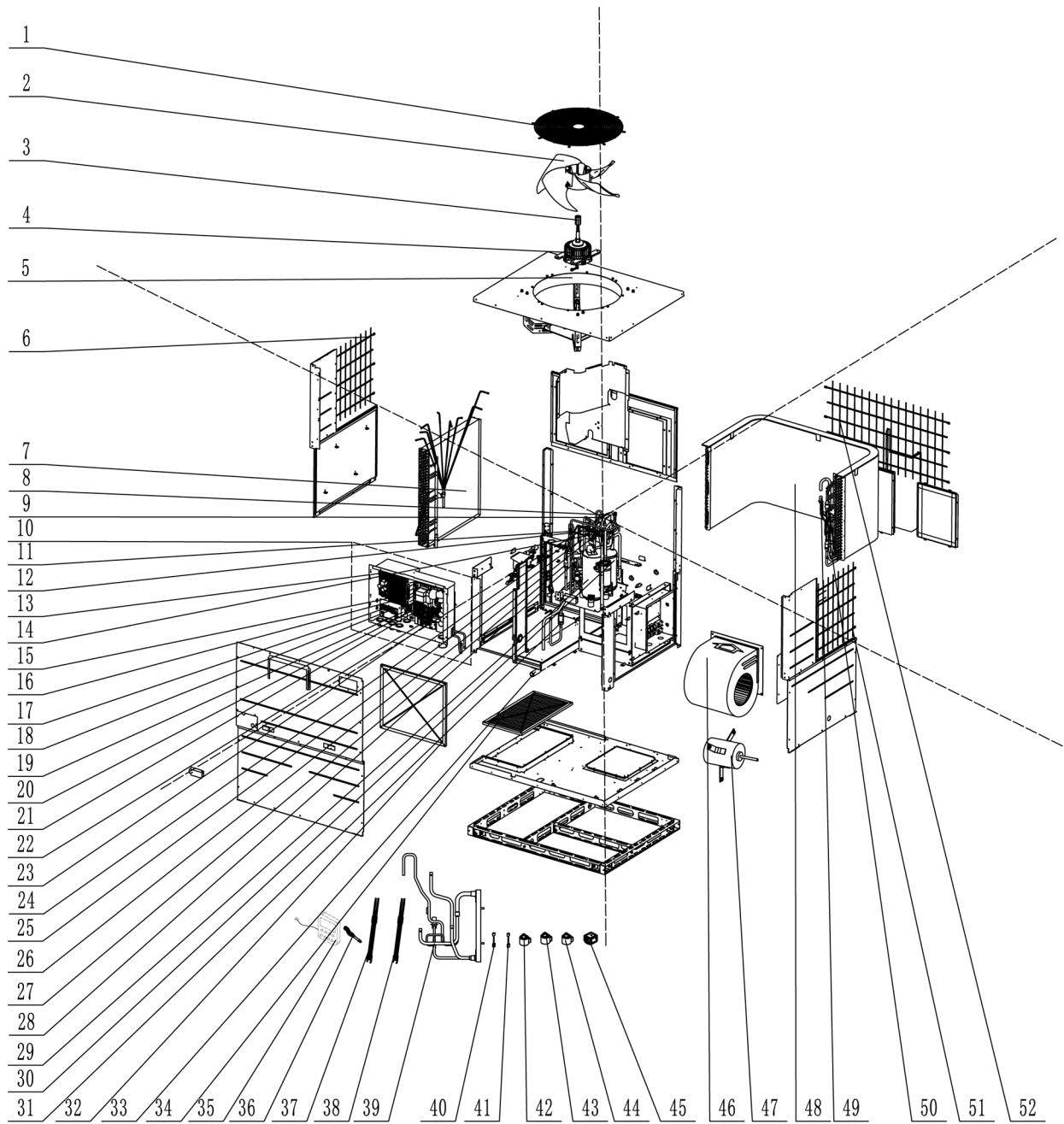

No.	Name	Code	Quantity
1	Rear Grill	01600106015001	1
2	Axial Flow Fan	103002060011	1
3	Axial Flow Fan Nesting	02204102	1
4	Brushless DC Motor	150104060129	1
5	Diversion Circle	01523901P	1
6	Rear Grill	01600106015001	1
7	Evaporator Assy	011001062845	1
8	Fusible Plug	035222000004	1
9	4-way Valve	030072060444	1

No.	Name	Code	Quantity
10	Electric Box Assy	100002082082	1
11	One Way Valve	071001060011	2
12	Nozzle for Adding Freon	06120012	1
13	Main Board	300027063166	1
14	Nozzle for Adding Freon	06120012	1
15	Radiator	43003406003306	1
16	Fan Board	300094000060	1
17	Terminal Board	42011103	1
18	Terminal Board	42011147	1
19	Transformer	43110286	1
20	Terminal Board	42011103	1
21	Main Board	300027061434	1
22	Terminal Board	4201025502	1
23	Terminal Board	42200006005405	1
24	Electronic Expansion Valve	072009060033	1
25	Nozzle for Adding Freon	06120012	1
26	Pressure Protect Switch	4602000919	1
27	Strainer	035021060018	1
28	Electronic Expansion Valve	072009060018	1
29	Compressor and Fittings	009001060517ST	1
30	Gas-Liquid Separator	035027060001	1
31	Gas Tube Filter	072190512	1
32	Filter Sub-Assy	111001060292	1
33	Drainage Hose	012146060040	1
34	Filter Sub-Assy	111001060292	1
35	Display Board	300001000204	1
36	Sensor Sub-Assy	390002060379	1
37	Electrical Heater(Compressor)	7651521215	1
38	Electrical Heater	7651521215	1
39	Plate-Type Heat Exchanger	010007060010	1
40	Pressure Sensor	32210100	1
41	Pressure Sensor	32210103	1
42	Electric Expand Valve Fitting	4304413256	1
43	Electric Expand Valve Fitting	072009060018	1
44	Electric Expand Valve Fitting	07200206002341	1
45	4 Way Valve Coil	07201006000601	1
46	Centrifugal Fan Housing	000052060774	1
47	Brushless DC Motor	15010400001403	1
48	Condenser Assy	000100060715	1
49	Electronic Expansion Valve	072009060018	1
50	Bidirection Strainer	0721004401	1
51	Rear Grill	01600106015001	1
52	Rear Grill	01600106015001	1

5.2 Model: GK-H04TC/NaA-T(U),GK-H05TC/NaA-T(U)

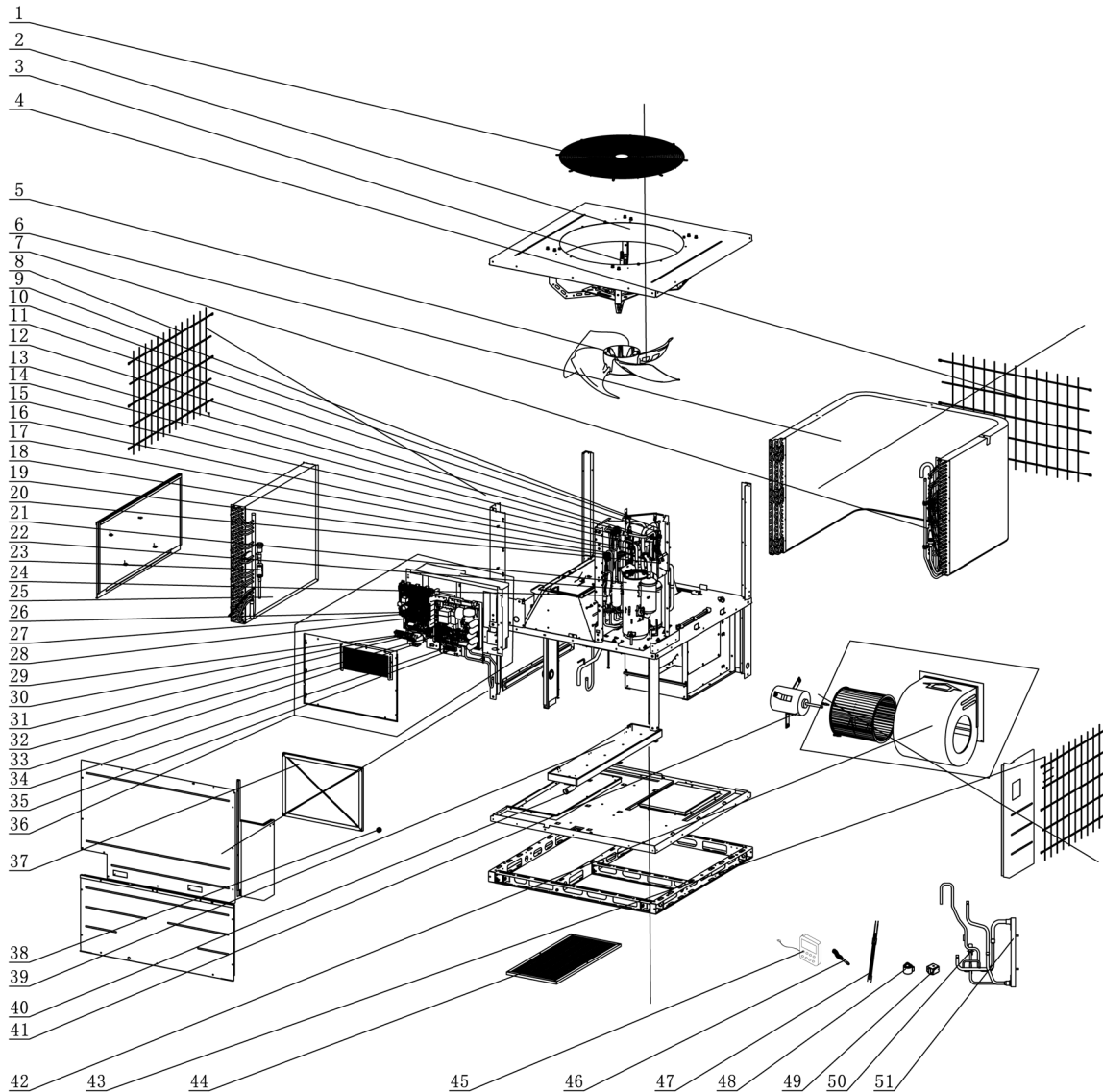

No.	Name	Code	Quantity
1	Rear Grill	016001060151	1
2	Diversion Circle	012193060010	1
3	Brushless DC Motor	1570411901	1
4	Rear Grill	01600106012101	1
5	Axial Flow Fan	103002000007	1
6	Condenser Assy	000100060611	1
7	Bidirection Strainer	0721004401	1
8	Rear Grill	01600106012101	1
9	Pressure Sensor	32210103	1
10	Pressure Sensor	32210100	1
11	Fusible Plug	035222000004	1
12	Nozzle for Adding Freon	06120012	1
13	Electric Expand Valve Fitting	4304413256	1
14	Electronic Expansion Valve	030026061382	1
15	4-Way Valve	43000338	1

No.	Name	Code	Quantity
16	Pressure Protect Switch	4602000910	1
17	One Way Valve	071001060011	1
18	Electronic Expansion Valve	072009060008	1
19	Electric Expand Valve Fitting	4300034502	1
20	Nozzle for Adding Freon	06120012	1
21	Compressor and Fittings	009001060980	1
22	Gas-Liquid Separator	035027060001	1
23	Gas Tube Filter	072190512	1
24	Strainer	035021060018	2
25	Evaporator Assy	011001062607	1
26	Main Board	300027063061	1
27	Radiator	43003406003306	1
28	Fan Board	300094000052	1
29	Terminal Board	42200006001202	1
30	Terminal Board	4201025502	1
31	Terminal Board	42200006005405	1
32	Main Board	300027063061	1
33	Transformer	43110286	1
34	Terminal Board	42011103	1
35	Terminal Board	42011147	1
36	Electric Box Assy	100002078181	1
37	Filter Sub-Assy	111001060400	1
38	Choke Plug	76718209	1
39	Water Tray	012122061115	1
40	Drainage Hose	012146060040	1
41	Brushless DC Motor	15010400001303	1
42	Centrifugal Fan Housing	1570220301	1
43	Rear Grill	01600106012101	1
44	Filter Sub-Assy	111001060370	1
45	Display Board	300001000204	1
46	Sensor Sub-Assy	390002060379	1
47	Electrical Heater(Compressor)	7651521216	1
48	Electric Expand Valve Fitting	07200206002342	1
49	4 Way Valve Coil	07201006000601	1
50	Electronic Expansion Valve	072009060011	1
51	Plate-Type Heat Exchanger	00904100004	1

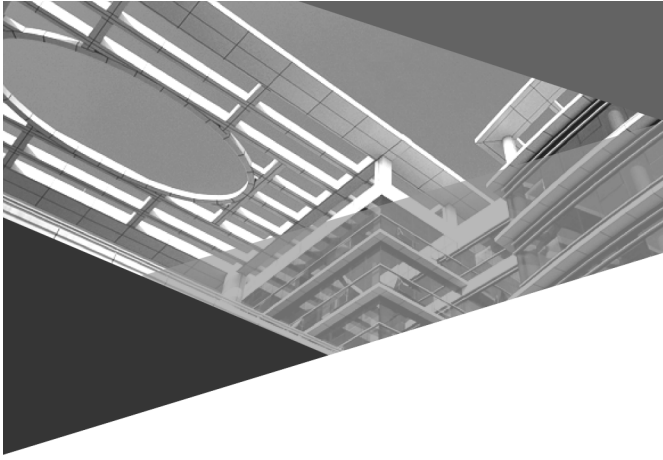

GREE ELECTRIC APPLIANCES, INC. OF ZHUHAI 519070

Add: West Jinji Rd, Qianshan Zhuhai, Guangdong, China

Tel: (+86-756)8522218

Fax: (+86-756)8669426

E-mail: global@cn.gree.com www.gree.com

JF00305555