



SERVICE MANUAL

Single-Zone, Heat Pump System

115V and 230V, 9 - 24K Btu/h

Thank you for choosing our product.
Please read this Installation & Owner's Manual carefully before
operation and retain it for future reference.

If you lose this Manual, please contact your local distributor or
visit www.greecomcomfort.com/resources now to download and
file the electronic version.

Table of Contents

Part I : Technical Information	1
1. Summary	1
2. Specifications	2-15
2.1 Specification Sheet.....	2-13
2.2 Capacity Variation Ratio According to Temperature	14
2.3 Cooling and Heating Data Sheet in Rated Frequency	15
2.4 Noise Curve	15
3.Outline Dimension Diagram	16-18
3.1 Indoor Unit.....	16
3.2 Outdoor Unit.....	17-18
4.Refrigerant System Diagram	19-20
5.Electrical Part	21-28
5.1 Wiring Diagram.....	21-24
5.2 PCB Printed Diagram.....	25-28
6.Function and Control	29-38
6.1 Remote Controller Introduction of YAP1F7F(WiFi)	29-33
6.2 GREE+ App Operation Manual.....	34
6.3 Ewpe Smart App Operation Manual	35
6.4 Brief Description of Modes and Functions.....	36-38
Part II : Installation and Maintenance	39-70
7.Notes for Installation and Maintenance	39-41
8.Installation	42-48
8.1 Installation Dimension Diagram & Procedures.....	39-40
8.2 Installation Parts-checking	44
8.3 Selection of Installation Location.....	44
8.4 Electric Connection Requirement	44

8.5 Installation of Indoor Unit.....	44-46
8.6 Installation of Outdoor unit.....	47-48
8.7 Vacuum Pumping and Leak Detection.....	48
8.8 Check after Installation and Test operation.....	48
9.Maintenance	49-66
9.1 Error Code List.....	49-55
9.2 Procedure of Troubleshooting.....	56-68
9.3 Troubleshooting for Normal Malfunction.....	69-70
10.Removal Procedure	71-94
11.1 Removal Procedure of Indoor Unit.....	71-76
11.2 Removal Procedure of Outdoor Unit.....	76-94
Appendix:	95-97
Appendix 1: Reference Sheet of Celsius and Fahrenheit	95
Appendix 2: Configuration of Connection Pipe	95
Appendix 3: Pipe Expanding Method.....	96
Appendix 4: List of Resistance for Temperature Sensor	97

2. Specifications

2.1 Specification Sheet

Model		3VIR09HP115V1A	
Product Code		CB385005800	
Power Supply	Rated Voltage	V~	115
	Rated Frequency	Hz	60
	Phases		1
Power Supply Mode		Outdoor	
Cooling Capacity		Btu/h	9100
Heating Capacity		W	10000
Cooling Power Input		W	626
Heating Power Input		W	715
Cooling Power Current		A	6.43
Heating Power Current		A	7.42
Rated Input		W	1410
Rated Cooling Current		A	12.2
Rated Heating Current		A	14.36
Air Flow Volume(SS/H/MH/M/ML/L/SL/SM)		CFM	353/324/294/265/235/206/194/129
Dehumidifying Volume		Pint/h	1.69
EER		(Btu/h)/W	14.55
COP		(Btu/h)/W	14
SEER			26.5
HSPF			11.2
Application Area		yd ²	53-57
Model of indoor unit		3VIR09HP115V1AH	
Indoor Unit Product Code		CB385N05800	
Fan Type		Cross-flow	
Fan Diameter Length(DXL)		mm	Φ98X630
Cooling Speed		r/min	1300/1200/1100/1000/900/800/750/500
Heating Speed		r/min	1300/1200/1100/1000/900/850/800/-
Fan Motor Power Output		W	15
Fan Motor RLA		A	0.30
Fan Motor Capacitor		μF	/
Evaporator Form		Aluminum Fin-copper Tube	
Evaporator Pipe Diameter		mm	Φ5
Evaporator Row-fin Gap		mm	2-1.4
Evaporator Coil Length (LXDXW)		mm	634 X 22.8 X 304.8
Swing Motor Model		MP24AK/MP24BA/MP24HF	
Swing Motor Power Output		W	1.5/1.5/1.5
Fuse Current		A	3.15
Sound Pressure Level		dB (A)	Cooling: 40/37/34/31/29/26/24/22 Heating: 41/38/35/31/29/26/25/-
Sound Power Level		dB (A)	Cooling: 50/47/44/41/39/36/34/32 Heating: 51/48/45/41/39/36/35/-
Dimension (WXHXD)		inch	32 31/64 X 11 34/64 X 7 46/64
Dimension of Carton Box (LXWXH)		inch	34 16/64 X 13 47/64 X 10 8/64
Dimension of Package (LXWXH)		inch	34 29/64 X 14 24/64 X 10 35/64
Net Weight		lb	20.9
Gross Weight		lb	25.4

2. Specifications

Outdoor Unit	Outdoor Unit Model		3VIR09HP115V1AO
	Outdoor Unit Product Code		CB385W05800
	Compressor Manufacturer		ZHUHAI LANDA COMPRESSOR CO.,LTD
	Compressor Model		QXF-B103zF190A
	Compressor Oil		FW68DA
	Compressor Type		Rotary
	Compressor LRA	A	/
	Compressor RLA	A	12.50
	Compressor Power Input	W	800
	Compressor Overload Protector		HPC115/95U1 KSD115°C
	Throttling Method		Electron expansion valve
	Set Temperature Range	°F	61~86
	Cooling Operation Ambient Temperature Range	°F	-13~122
	Heating Operation Ambient Temperature Range	°F	-22~86
	Condenser Form		Aluminum Fin-copper Tube
	Condenser Pipe Diameter	mm	Φ7.94
	Condenser Rows-fin Gap	mm	2-1.4
	Condenser Coil Length (LXDXW)	mm	742 X 38.1 X 550
	Fan Motor Speed	rpm	900
	Fan Motor Power Output	W	30
	Fan Motor RLA	A	0.50
	Fan Motor Capacitor	μF	/
	Outdoor Unit Air Flow Volume	CFM	1295
	Fan Type		Axial-flow
	Fan Diameter	mm	Φ438
	Defrosting Method		/
	Climate Type		T1
	Isolation		I
	Moisture Protection		IPX4
	Permissible Excessive Operating Pressure for the Discharge Side	MPa	4.3
	Permissible Excessive Operating Pressure for the Suction Side	MPa	2.5
	Sound Pressure Level (H/M/L)	dB (A)	52/-/-
	Sound Power Level (H/M/L)	dB (A)	62/-/-
Dimension(WXHXD)	inch	33 25/64 X 23 30/64 X 12 38/64	
Dimension of Carton Box (LXWXH)	inch	34 36/64 X 14 11/64 X 24 51/64	
Dimension of Package(LXWXH)	inch	34 44/64 X 14 19/64 X 25 25/64	
Net Weight	lb	75	
Gross Weight	lb	81.6	
Refrigerant		R410A	
Refrigerant Charge	oz	35.3	
Connection Pipe	Connection Pipe Length	ft	24.6
	Connection Pipe Gas Additional Charge	oz/ft	0.2
	Outer Diameter Liquid Pipe	inch	1/4
	Outer Diameter Gas Pipe	inch	3/8
	Max Distance Height	ft	32.8
	Max Distance Length	ft	49.2
Note: The connection pipe applies metric diameter.			

The above data is subject to change without notice. Please refer to the nameplate of the unit.

2. Specifications

Model			3VIR09HP230V1A
Product Code			CB385002900
Power Supply	Rated Voltage	V~	208/230
	Rated Frequency	Hz	60
	Phases		1
Power Supply Mode			outdoor
Cooling Capacity		Btu/h	9100
Heating Capacity		W	3224
Cooling Power Input		W	618
Heating Power Input		W	860
Cooling Power Current		A	3.0
Heating Power Current		A	4.2
Rated Input		W	1650
Rated Cooling Current		A	7.2
Rated Heating Current		A	7.2
Air Flow Volume(SS/H/MH/M/ML/L/SL/SM)		CFM	353/324/294/265/235/206/194/129
Dehumidifying Volume		Pint/h	1.69
EER		(Btu/h)/W	14.70
COP		(Btu/h)/W	12.79
SEER			25.3
HSPF			11.2
Application Area		yd ²	14.35-21.53
Indoor Unit	Model of indoor unit		3VIR09HP230V1AH
	Indoor Unit Product Code		CB385N02900
	Fan Type		Cross-flow
	Fan Diameter Length(DXL)		mm Φ98X630
	Cooling Speed		r/min 1300/1200/1100/1000/900/800/750/500
	Heating Speed		r/min 1300/1200/1100/1000/900/850/800/-
	Fan Motor Power Output		W 15
	Fan Motor RLA		A 0.22
	Fan Motor Capacitor		μF /
	Evaporator Form		Aluminum Fin-copper Tube
	Evaporator Pipe Diameter		mm Φ5
	Evaporator Row-fin Gap		mm 2-1.4
	Evaporator Coil Length (LXDXW)		mm 634 X 22.8 X 304.8
	Swing Motor Model		MP24AK/MP24BA/MP24HF
	Swing Motor Power Output		W 1.5/1.5/1.5
	Fuse Current		A 3.15
	Sound Pressure Level		dB (A) Cooling: 40/37/35/32/29/26/25/22 Heating: 41/38/36/33/29/27/25/-
	Sound Power Level		dB (A) Cooling: 50/47/45/42/39/36/35/32 Heating: 51/48/46/43/39/37/35/-
	Dimension (WXHxD)		inch 32 31/64 X 11 34/64 X 7 46/64
	Dimension of Carton Box (LXWXH)		inch 34 16/64 X 13 47/64 X 10 8/64
	Dimension of Package (LXWXH)		inch 34 29/64 X 14 24/64 X 10 35/64
Net Weight		lb 20.9	
Gross Weight		lb 25.4	

2. Specifications

Outdoor Unit	Outdoor Unit Model		3VIR09HP230V1AO
	Outdoor Unit Product Code		CB385W02900
	Compressor Manufacturer		ZHUHAI LANDA COMPRESSOR CO.,LTD
	Compressor Model		QXF-B103zF190A
	Compressor Oil		FW68DA or equivalent
	Compressor Type		Rotary
	Compressor LRA	A	/
	Compressor RLA	A	4.7
	Compressor Power Input	W	860
	Compressor Overload Protector		HPC115/95U1 KSD115°C
	Throttling Method		Capillary
	Set Temperature Range	°F	61~86
	Cooling Operation Ambient Temperature Range	°F	-20~122
	Heating Operation Ambient Temperature Range	°F	-22~86
	Condenser Form		Aluminum Fin-copper Tube
	Condenser Pipe Diameter	mm	Φ7
	Condenser Rows-fin Gap	mm	2-1.4
	Condenser Coil Length (LXDXW)	mm	742 X 38.1 X 550
	Fan Motor Speed	rpm	900
	Fan Motor Power Output	W	30
	Fan Motor RLA	A	0.4
	Fan Motor Capacitor	μF	/
	Outdoor Unit Air Flow Volume	CFM	1295
	Fan Type		Axial-flow
	Fan Diameter	mm	Φ438
	Defrosting Method		Automatic Defrosting
	Climate Type		T1
	Isolation		I
	Moisture Protection		IPX4
	Permissible Excessive Operating Pressure for the Discharge Side	MPa	4.3
	Permissible Excessive Operating Pressure for the Suction Side	MPa	2.5
	Sound Pressure Level (H/M/L)	dB (A)	52/-/-
Sound Power Level (H/M/L)	dB (A)	62/-/-	
Dimension(WXHXD)	inch	33 25/64 X 23 30/64 X 12 38/64	
Dimension of Carton Box (LXWXH)	inch	34 36/64 X 14 11/64 X 24 51/64	
Dimension of Package(LXWXH)	inch	34 44/64 X 14 19/64 X 25 25/64	
Net Weight	lb	73.9	
Gross Weight	lb	80.5	
Refrigerant		R410A	
Refrigerant Charge	oz	36.3	
Connection Pipe	Connection Pipe Length	ft	24.6
	Connection Pipe Gas Additional Charge	oz/ft	0.2
	Outer Diameter Liquid Pipe	inch	1/4
	Outer Diameter Gas Pipe	inch	3/8
	Max Distance Height	ft	32.8
	Max Distance Length	ft	49.2
Note: The connection pipe applies metric diameter.			

The above data is subject to change without notice. Please refer to the nameplate of the unit.

2. Specifications

Model			3VIR12HP115V1A	
Product Code			CB385006200	
Power Supply	Rated Voltage	V~	115	
	Rated Frequency	Hz	60	
	Phases		1	
Power Supply Mode			Outdoor	
Cooling Capacity		Btu/h	12100	
Heating Capacity		W	12100	
Cooling Power Input		W	931	
Heating Power Input		W	982	
Cooling Power Current		A	8.26	
Heating Power Current		A	8.53	
Rated Input		W	1500	
Rated Cooling Current		A	12.45	
Rated Heating Current		A	13.1	
Air Flow Volume(SS/H/MH/M/ML/L/SL/SM)		CFM	400/365/330/288/265/247/230/212	
Dehumidifying Volume		Pint/h	2.96	
EER		(Btu/h)/W	13.00	
COP		(Btu/h)/W	12.32	
SEER			25	
HSPF			11.5	
Application Area		yd ²	19-29	
Indoor Unit	Model of indoor unit		3VIR12HP115V1AH	
	Indoor Unit Product Code		CB385N06200	
	Fan Type		Cross-flow	
	Fan Diameter Length(DXL)		mm	Φ98X630
	Cooling Speed		r/min	1450/1200/1120/1050/980/920/750/500
	Heating Speed		r/min	1450/1200/1140/1080/1020/960/900/-
	Fan Motor Power Output		W	15
	Fan Motor RLA		A	0.30
	Fan Motor Capacitor		μF	/
	Evaporator Form			Aluminum Fin-copper Tube
	Evaporator Pipe Diameter		mm	Φ5
	Evaporator Row-fin Gap		mm	2-1.4
	Evaporator Coil Length (LXDXW)		mm	634X22.8X304.8
	Swing Motor Model			MP24BA/MP24AK/MP24HF
	Swing Motor Power Output		W	1.5/1.5/1.5
	Fuse Current		A	3.15
	Sound Pressure Level		dB (A)	Cooling: 43/38/35/33/31/29/25/20 Heating: 44/38/36/34/32/30/28/-
	Sound Power Level		dB (A)	Cooling: 53/48/45/43/41/39/35/30 Heating: 54/48/46/44/42/40/38/-
	Dimension (WXHxD)		inch	32 31/64 X 11 34/64 X 7 46/64
	Dimension of Carton Box (LXWXH)		inch	34 16/64 X 13 47/64 X 10 8/64
Dimension of Package (LXWXH)		inch	34 29/64 X 14 24/64 X 10 35/64	
Net Weight		lb	20.9	
Gross Weight		lb	25.4	

2. Specifications

	Outdoor Unit Model		3VIR12HP115V1AO
	Outdoor Unit Product Code		CB385W06200
	Compressor Manufacturer		ZHUHAI LANDA COMPRESSOR CO.,LTD
	Compressor Model		QXF-B103zF190A
	Compressor Oil		FW68DA
	Compressor Type		Rotary
	Compressor LRA	A	25
	Compressor RLA	A	15
	Compressor Power Input	W	800
	Compressor Overload Protector		/
	Throttling Method		Electron expansion valve
	Set Temperature Range	°F	61~86
	Cooling Operation Ambient Temperature Range	°F	-13~122
	Heating Operation Ambient Temperature Range	°F	-22~86
	Condenser Form		Aluminum Fin-copper Tube
	Condenser Pipe Diameter	mm	Φ7.94
	Condenser Rows-fin Gap	mm	2.5-1.5
	Condenser Coil Length (LXDXW)	mm	733X57X550
	Fan Motor Speed	rpm	900
	Fan Motor Power Output	W	30
	Fan Motor RLA	A	0.50
	Fan Motor Capacitor	μF	/
	Outdoor Unit Air Flow Volume	CFM	1412
	Fan Type		Axial-flow
	Fan Diameter	mm	Φ438
	Defrosting Method		Automatic Defrosting
	Climate Type		T1
	Isolation		I
	Moisture Protection		IPX4
	Permissible Excessive Operating Pressure for the Discharge Side	MPa	4.3
	Permissible Excessive Operating Pressure for the Suction Side	MPa	2.5
	Sound Pressure Level (H/M/L)	dB (A)	54/-/-
	Sound Power Level (H/M/L)	dB (A)	64/-/-
	Dimension(WXHxD)	inch	35 25/64 X 23 30/64 X 14 56/64
	Dimension of Carton Box (LXWXH)	inch	37 13/64 X 16 27/64 X 24 51/64
	Dimension of Package(LXWXH)	inch	37 21/64 X 16 34/64 X 25 25/64
	Net Weight	lb	87.1
	Gross Weight	lb	93.7
	Refrigerant		R410A
	Refrigerant Charge	oz	47.3
	Connection Pipe Length	ft	24.6
	Connection Pipe Gas Additional Charge	oz/ft	0.2
	Outer Diameter Liquid Pipe	inch	1/4
	Outer Diameter Gas Pipe	inch	1/2
	Max Distance Height	ft	32.8
	Max Distance Length	ft	65.6
	Note: The connection pipe applies metric diameter.		

The above data is subject to change without notice. Please refer to the nameplate of the unit.

2. Specifications

Model			3VIR12HP230V1A
Product Code			CB385004000
Power Supply	Rated Voltage	V~	208/230
	Rated Frequency	Hz	60
	Phases		1
Power Supply Mode			outdoor
Cooling Capacity		Btu/h	12000
Heating Capacity		W	12000
Cooling Power Input		W	923
Heating Power Input		W	974
Cooling Power Current		A	4.05
Heating Power Current		A	4.38
Rated Input		W	1500
Rated Current		A	7.5
Air Flow Volume(SS/H/MH/M/ML/L/SL/SM)		CFM	400/365/330/288/265/247/230/212
Dehumidifying Volume		Pint/h	2.96
EER		(Btu/h)/W	13.00
COP		(Btu/h)/W	12.32
SEER			25
HSPF			11.5
Application Area		yd ²	19.14-28.70
Indoor Unit	Model of indoor unit		3VIR12HP230V1AH
	Indoor Unit Product Code		CB385N04000
	Fan Type		Cross-flow
	Fan Diameter Length(DXL)		mm Φ98X630
	Cooling Speed		r/min 1450/1200/1120/1050/980/920/750/500
	Heating Speed		r/min 1450/1200/1140/1080/1020/960/900/-
	Fan Motor Power Output		W 15
	Fan Motor RLA		A 0.20
	Fan Motor Capacitor		μF /
	Evaporator Form		Aluminum Fin-copper Tube
	Evaporator Pipe Diameter		mm Φ5
	Evaporator Row-fin Gap		mm 2-1.4
	Evaporator Coil Length (LXDXW)		mm 634X22.8X304.8
	Swing Motor Model		MP24BA/MP24AK/MP24HF
	Swing Motor Power Output		W 1.5/1.5/1.5
	Fuse Current		A 3.15
	Sound Pressure Level		dB (A) Cooling: 43/38/35/33/31/29/27/23 Heating: 44/38/36/34/32/30/28/-
	Sound Power Level		dB (A) Cooling: 53/48/45/43/41/39/37/33 Heating: 54/48/46/44/42/40/38/-
	Dimension (WXHxD)		inch 32 31/64 X 11 34/64 X 7 46/64
	Dimension of Carton Box (LXWXH)		inch 34 16/64 X 13 47/64 X 10 8/64
Dimension of Package (LXWXH)		inch 34 29/64 X 14 24/64 X 10 35/64	
Net Weight		lb 20.9	
Gross Weight		lb 25.4	

2. Specifications

	Outdoor Unit Model		3VIR12HP230V1AO
	Outdoor Unit Product Code		CB385W04000
	Compressor Manufacturer		ZHUHAI LANDA COMPRESSOR CO.,LTD
	Compressor Model		QXF-B103zF190A
	Compressor Oil		FW68DA
	Compressor Type		Rotary
	Compressor LRA	A	25
	Compressor RLA	A	6.60
	Compressor Power Input	W	800
	Compressor Overload Protector		/
	Throttling Method		Electron expansion valve
	Set Temperature Range	°F	61~86
	Cooling Operation Ambient Temperature Range	°F	-20~122
	Heating Operation Ambient Temperature Range	°F	-22~86
	Condenser Form		Aluminum Fin-copper Tube
	Condenser Pipe Diameter	mm	Φ7.94
	Condenser Rows-fin Gap	mm	2.5-1.4
	Condenser Coil Length (LXDXW)	mm	733X57X550
	Fan Motor Speed	rpm	900
	Fan Motor Power Output	W	30
	Fan Motor RLA	A	0.37
	Fan Motor Capacitor	μF	/
	Outdoor Unit Air Flow Volume	CFM	1412
	Fan Type		Axial-flow
	Fan Diameter	mm	Φ438
	Defrosting Method		Automatic Defrosting
	Climate Type		T1
	Isolation		I
	Moisture Protection		IPX4
	Permissible Excessive Operating Pressure for the Discharge Side	MPa	4.3
	Permissible Excessive Operating Pressure for the Suction Side	MPa	2.5
	Sound Pressure Level (H/M/L)	dB (A)	52/-/-
	Sound Power Level (H/M/L)	dB (A)	62/-/-
	Dimension(WXHXD)	inch	35 25/64 X 23 30/64 X 14 56/64
	Dimension of Carton Box (LXWXH)	inch	37 13/64 X 16 27/64 X 24 51/64
	Dimension of Package(LXWXH)	inch	37 21/64 X 16 34/64 X 25 25/64
	Net Weight	lb	83.8
	Gross Weight	lb	90.4
	Refrigerant		R410A
	Refrigerant Charge	oz	47.3
	Connection Pipe Length	ft	24.6
	Connection Pipe Gas Additional Charge	oz/ft	0.2
	Outer Diameter Liquid Pipe	inch	1/4
	Outer Diameter Gas Pipe	inch	1/2
	Max Distance Height	ft	32.8
	Max Distance Length	ft	65.6
	Note: The connection pipe applies metric diameter.		

The above data is subject to change without notice. Please refer to the nameplate of the unit.

2. Specifications

Model			3VIR18HP230V1A	
Product Code			CB385004400	
Power Supply	Rated Voltage	V~	208/230	
	Rated Frequency	Hz	60	
	Phases		1	
Power Supply Mode			Outdoor	
Cooling Capacity		Btu/h	18000	
Heating Capacity		W	18200	
Cooling Power Input		W	1384	
Heating Power Input		W	1460	
Cooling Power Current		A	6	
Heating Power Current		A	6.4	
Rated Input		W	2600	
Rated Current		A	11	
Air Flow Volume(SS/H/MH/M/ML/L/SL/SM)		CFM	618/530/471/441/412/383/353/294	
Dehumidifying Volume		Pint/h	3.8	
EER		(Btu/h)/W	13	
COP		(Btu/h)/W	12.45	
SEER			23	
HSPF			11	
Application Area		yd ²	28-41	
Indoor Unit	Model of indoor unit		3VIR18HP230V1AH	
	Indoor Unit Product Code		CB385N04400	
	Fan Type		Cross-flow	
	Fan Diameter Length(DXL)		mm	Φ106X739
	Cooling Speed		r/min	1400/1200/1120/1050/980/860/750/-
	Heating Speed		r/min	1400/1200/1120/1050/950/850/750/-
	Fan Motor Power Output		W	60
	Fan Motor RLA		A	0.25
	Fan Motor Capacitor		μF	/
	Evaporator Form			Aluminum Fin-copper Tube
	Evaporator Pipe Diameter		mm	Φ7
	Evaporator Row-fin Gap		mm	2-1.4
	Evaporator Coil Length (LXDXW)		mm	745X22.8X342.9
	Swing Motor Model			MP24BA/MP24AK/MP24HF
	Swing Motor Power Output		W	1.5/1.5/1.5
	Fuse Current		A	3.15
	Sound Pressure Level		dB (A)	Cooling: 46/42/40/38/36/34/31/26 Heating: 49/42/41/39/36/32/28/-
	Sound Power Level		dB (A)	Cooling: 56/52/50/48/46/44/41/36 Heating: 59/52/51/49/46/42/38/-
	Dimension (WXHXD)		inch	38 42/64 X 12 16/64 X 8 45/64
	Dimension of Carton Box (LXWXH)		inch	40 58/64 X 14 54/64 X 11 19/64
Dimension of Package (LXWXH)		inch	41 7/64 X 15 10/64 X 11 44/64	
Net Weight		lb	29.8	
Gross Weight		lb	35.3	

2. Specifications

	Outdoor Unit Model		3VIR18HP230V1AO
	Outdoor Unit Product Code		CB385W04400
	Compressor Manufacturer		ZHUHAI LANDA COMPRESSOR CO.,LTD
	Compressor Model		QXA-B141zF030A
	Compressor Oil		RB68EP
	Compressor Type		Rotary
	Compressor LRA.	A	25
	Compressor RLA	A	10.4
	Compressor Power Input	W	1440
	Compressor Overload Protector		1NT11L-6233 or KSD115°C or HPC115/95U1
	Throttling Method		Electron expansion valve
	Set Temperature Range	°F	61~86
	Cooling Operation Ambient Temperature Range	°F	-20~122
	Heating Operation Ambient Temperature Range	°F	-22~86
	Condenser Form		Aluminum Fin-copper Tube
	Condenser Pipe Diameter	mm	Φ7
	Condenser Rows-fin Gap	mm	2-1.4
	Condenser Coil Length (LXDXW)	mm	935X38.1X660
	Fan Motor Speed	rpm	820
Outdoor Unit	Fan Motor Power Output	W	60
	Fan Motor RLA	A	0.45
	Fan Motor Capacitor	μF	/
	Outdoor Unit Air Flow Volume	CFM	1883
	Fan Type		Axial-flow
	Fan Diameter	mm	Φ520
	Defrosting Method		Automatic Defrosting
	Climate Type		T1
	Isolation		I
	Moisture Protection		IPX4
	Permissible Excessive Operating Pressure for the Discharge Side	MPa	4.3
	Permissible Excessive Operating Pressure for the Suction Side	MPa	2.5
	Sound Pressure Level (H/M/L)	dB (A)	57/-/-
	Sound Power Level (H/M/L)	dB (A)	67/-/-
	Dimension(WXHxD)	inch	37 63/64 X 27 36/64 X 15 38/64
	Dimension of Carton Box (LXWXH)	inch	40 25/64 X 17 58/64 X 28 60/64
Dimension of Package(LXWXH)	inch	40 33/64 X 18 2/64 X 29 34/64	
Net Weight	lb	103.6	
Gross Weight	lb	113.6	
Refrigerant		R410A	
Refrigerant Charge	oz	56.4	
Connection Pipe	Connection Pipe Length	ft	24.6
	Connection Pipe Gas Additional Charge	oz/ft	0.5
	Outer Diameter Liquid Pipe	inch	1/4
	Outer Diameter Gas Pipe	inch	5/8
	Max Distance Height	ft	65.6
	Max Distance Length	ft	98.4
	Note: The connection pipe applies metric diameter.		

The above data is subject to change without notice. Please refer to the nameplate of the unit.

2. Specifications

Model			3VIR24HP230V1A	
Product Code			CB385002600	
Power Supply	Rated Voltage	V~	208/230	
	Rated Frequency	Hz	60	
	Phases		1	
Power Supply Mode			outdoor	
Cooling Capacity		Btu/h	22000	
Heating Capacity		W	24000	
Cooling Power Input		W	1692	
Heating Power Input		W	1846	
Cooling Power Current		A	7.5	
Heating Power Current		A	8	
Rated Input		W	3100	
Rated Current		A	14.5	
Air Flow Volume(SS/H/MH/M/ML/L/SL/SM)		CFM	824/589/571/500/471/441/400/-	
Dehumidifying Volume		Pint/h	5.07	
EER		(Btu/h)/W	13.00	
COP		(Btu/h)/W	13.00	
SEER			23	
HSPF			11	
Application Area		yd ²	32.29-50.23	
Indoor Unit	Model of indoor unit		3VIR24HP230V1AH	
	Indoor Unit Product Code		CB385N02600	
	Fan Type		Cross-flow	
	Fan Diameter Length(DXL)		mm	Φ108*830
	Cooling Speed		r/min	1500/1150/1100/1000/950/900/850/-
	Heating Speed		r/min	1500/1200/1100/1050/1000/950/900/-
	Fan Motor Power Output		W	60
	Fan Motor RLA		A	0.40
	Fan Motor Capacitor		μF	/
	Evaporator Form			Aluminum Fin-copper Tube
	Evaporator Pipe Diameter		mm	Φ7
	Evaporator Row-fin Gap		mm	2-1.4
	Evaporator Coil Length (LXD _X W)		mm	845X25.4X342.9
	Swing Motor Model			MP24HF/MP24AK/MP24HF
	Swing Motor Power Output		W	1.5/1.5/1.5
	Fuse Current		A	3.15
	Sound Pressure Level		dB (A)	Cooling: 53/45/44/41/39/37/35/- Heating: 51/45/42/40/39/37/36/-
	Sound Power Level		dB (A)	Cooling: 63/55/54/51/49/47/45/- Heating: 61/55/52/50/49/47/46/-
	Dimension (WXH _X D)		inch	42 21/64 X 13 7/64 X 9 44/64
	Dimension of Carton Box (LXWXH)		inch	44 26/64 X 15 63/64 X 12 46/64
Dimension of Package (LXWXH)		inch	44 39/64 X 16 19/64 X 13 7/64	
Net Weight		lb	35.3	
Gross Weight		lb	41.9	

2. Specifications

Outdoor Unit	Outdoor Unit Model		3VIR24HP230V1AO	
	Outdoor Unit Product Code		CB385W02600	
	Compressor Manufacturer		ZHUHAI LANDA COMPRESSOR CO.,LTD	
	Compressor Model		QXFS-B181zX030AA	
	Compressor Oil		FW68DA	
	Compressor Type		Twin Rotary	
	Compressor LRA	A		25
	Compressor RLA	A		10.68
	Compressor Power Input	W		1610
	Compressor Overload Protector			HPC115/95U1 KSD115 C
	Throttling Method			Electron expansion valve
	Set Temperature Range	°F		61~86
	Cooling Operation Ambient Temperature Range	°F		-20~122
	Heating Operation Ambient Temperature Range	°F		-22~86
	Condenser Form			Aluminum Fin-copper Tube
	Condenser Pipe Diameter	mm		Φ7.94
	Condenser Rows-fin Gap	mm		2-Φ8
	Condenser Coil Length (LXDXW)	mm		952×38.1×748
	Fan Motor Speed	rpm		800
	Fan Motor Power Output	W		90
	Fan Motor RLA	A		0.7
	Fan Motor Capacitor	μF		/
	Outdoor Unit Air Flow Volume	CFM		2354
	Fan Type			Axial-flow
	Fan Diameter	mm		Φ550
	Defrosting Method			Automatic Defrosting
	Climate Type			T1
	Isolation			I
	Moisture Protection			IPX4
	Permissible Excessive Operating Pressure for the Discharge Side	MPa		4.3
	Permissible Excessive Operating Pressure for the Suction Side	MPa		2.5
	Sound Pressure Level (H/M/L)	dB (A)		59/-/-
Sound Power Level (H/M/L)	dB (A)		69/-/-	
Dimension(WXHxD)	inch		39 31/64 X 31 7/64 X 16 52/64	
Dimension of Carton Box (LXWXH)	inch		42 33/64 X 19 6/64 X 33 5/64	
Dimension of Package(LXWXH)	inch		42 41/64 X 19 14/64 X 33 42/64	
Net Weight	lb		124.6	
Gross Weight	lb		135.6	
Refrigerant			R410A	
Refrigerant Charge	oz		63.5	
Connection Pipe	Connection Pipe Length	ft	24.6	
	Connection Pipe Gas Additional Charge	oz/ft	0.5	
	Outer Diameter Liquid Pipe	inch	1/4	
	Outer Diameter Gas Pipe	inch	5/8	
	Max Distance Height	ft	65.6	
	Max Distance Length	ft	98.4	
Note: The connection pipe applies metric diameter.				

The above data is subject to change without notice. Please refer to the nameplate of the unit.

2. Specifications

2.2 Capacity Variation Ratio According to Temperature

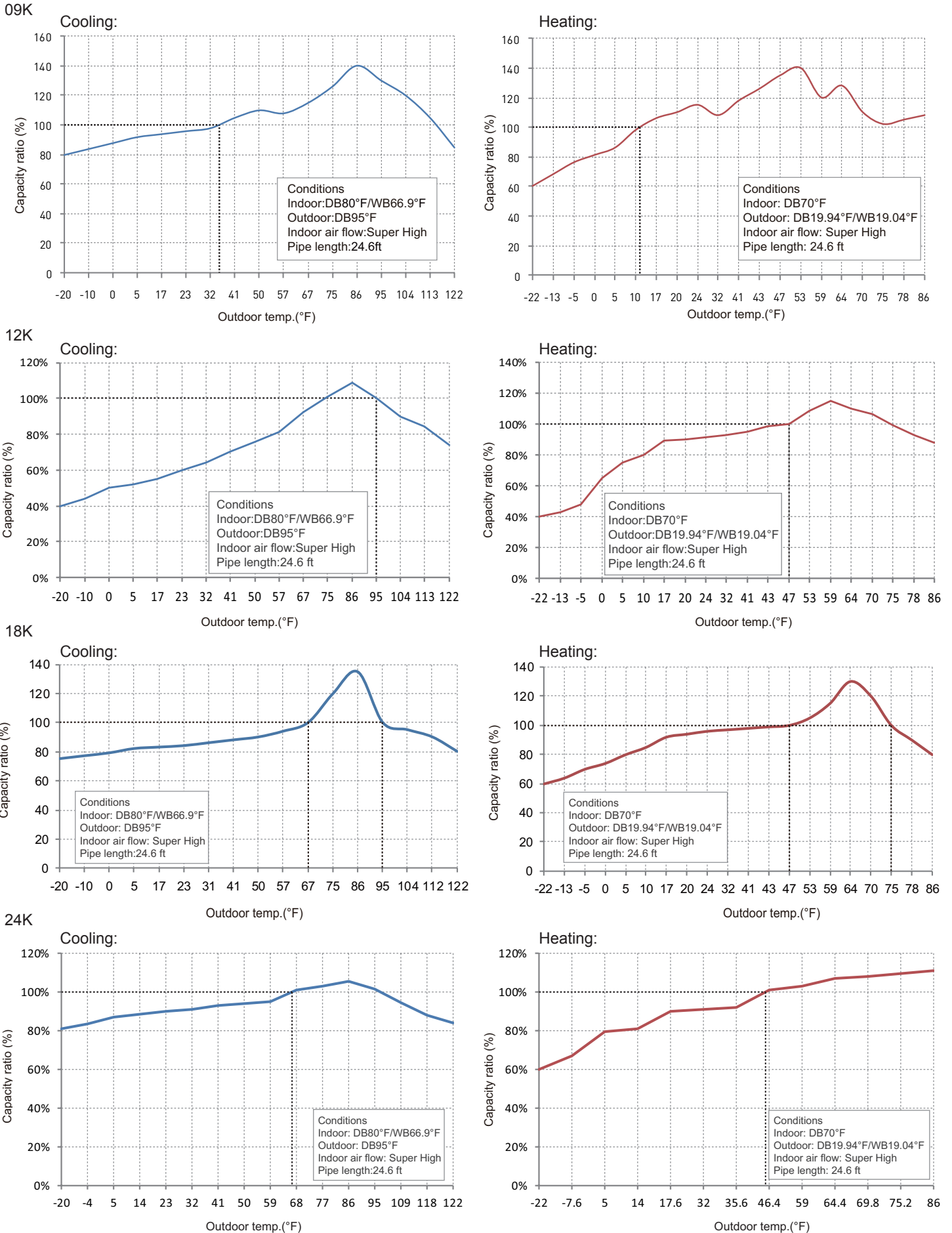

2. Specifications

2.3 Cooling and Heating Data Sheet in Rated Frequency

Cooling:

Rated cooling condition(°F) (DB/WB)		Model	Pressure of gas pipe connecting indoor and outdoor unit	Inlet and outlet pipe temperature of heat exchanger		Fan speed of indoor unit	Fan speed of outdoor unit
Indoor	Outdoor			T1 (°F)	T2 (°F)		
80/66.9	95/-	09K	0.9~1.1	53.6 to 57.2	158 to 104	Super High	High
80/66.9	95/-	12K	0.9~1.1	53.6 to 57.2	158 to 104	Super High	High
80/66.9	95/-	18K	0.9~1.1	53.6 to 57.2	176 to 104	Super High	High
80/66.9	95/-	24K	0.9~1.1	53.6 to 57.2	176 to 104	Super High	High

Heating:

Rated heating condition(°F) (DB/WB)		Model	Pressure of gas pipe connecting indoor and outdoor unit	Inlet and outlet pipe temperature of heat exchanger		Fan speed of indoor unit	Fan speed of outdoor unit
Indoor	Outdoor			T1 (°F)	T2 (°F)		
70/-	19.94/19.04	09K	2.2~2.4	158 to 95	35.6 to 39.2	Super High	High
70/-	19.94/19.04	12K	2.2~2.4	158 to 95	35.6 to 39.2	Super High	High
70/-	19.94/19.04	18K	2.5~2.7	158 to 104	33.8 to 41.0	Super High	High
70/-	19.94/19.04	24K	2.5~2.7	158 to 104	33.8 to 41.0	Super High	High

Instruction:

T1: Inlet and outlet pipe temperature of evaporator

T2: Inlet and outlet pipe temperature of condenser

P: Pressure at the side of big valve

Connection pipe length: 24.6ft.

2.4 Noise Curve

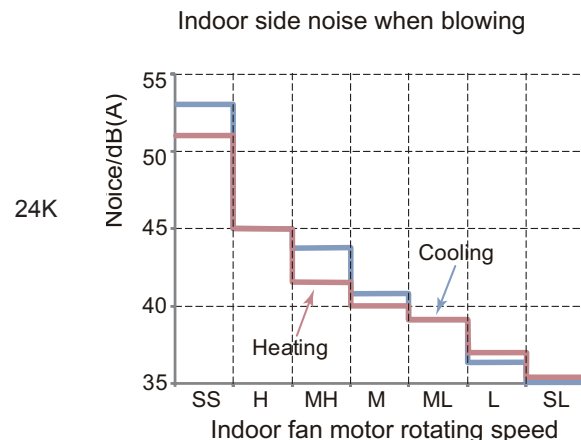
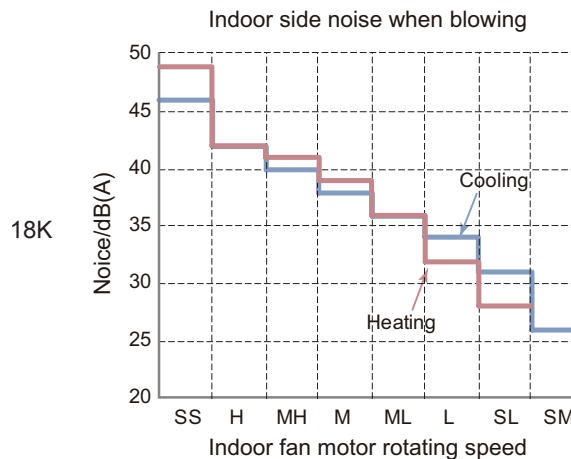
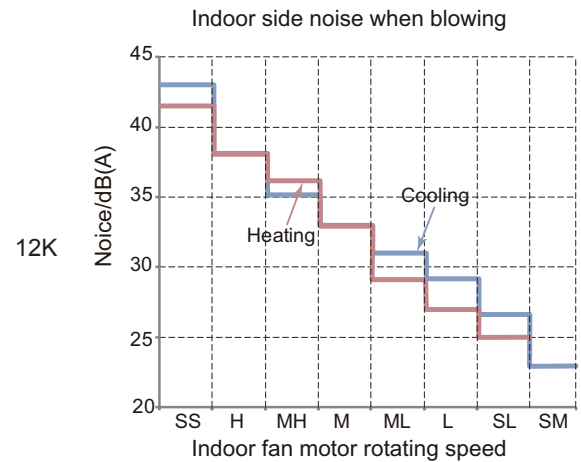
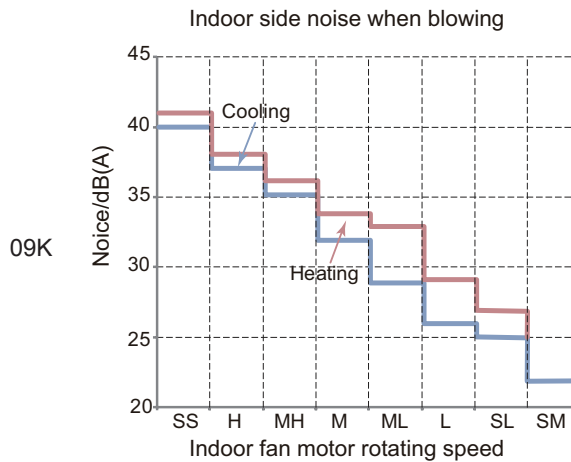

3. Outline Dimension Diagram

3.1 Indoor Unit

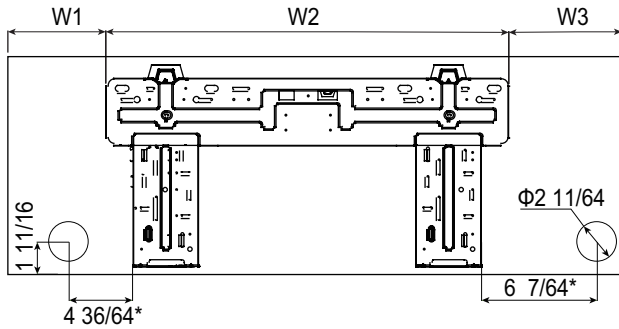
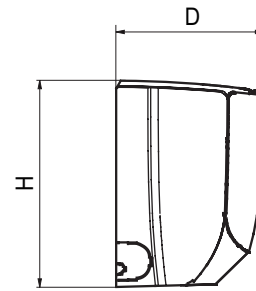
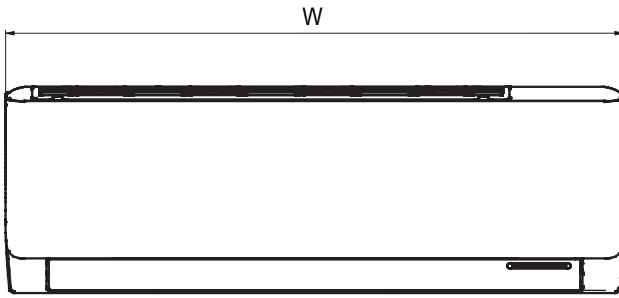

09K & 12K

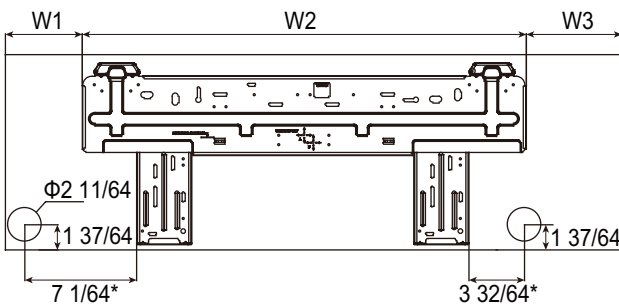

18K

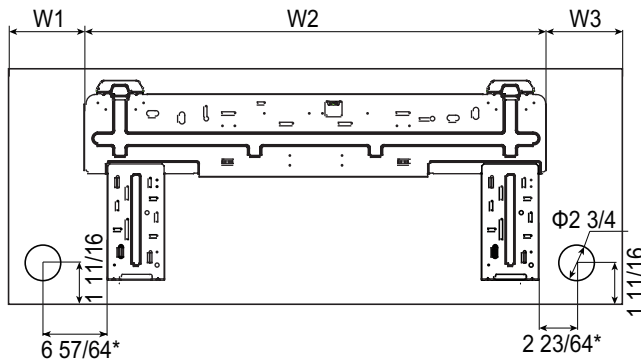

24K

Model	W	H	D	W1	W2	W3
09K & 12K	32 31/64	11 34/64	7 46/64	4 29/64	21 22/64	6 44/64
18K	38 42/64	12 16/64	8 45/64	4 53/64	27 55/64	5 63/64
24K	42 21/64	13 7/64	9 44/64	7 14/64	27 55/64	7 16/64

* Recommending distances

Unit:inch

3. Outline Dimension Diagram

3.2 Outdoor Unit

3VIR09HP115V1AO GWC09AGC-D3DNA1C/O

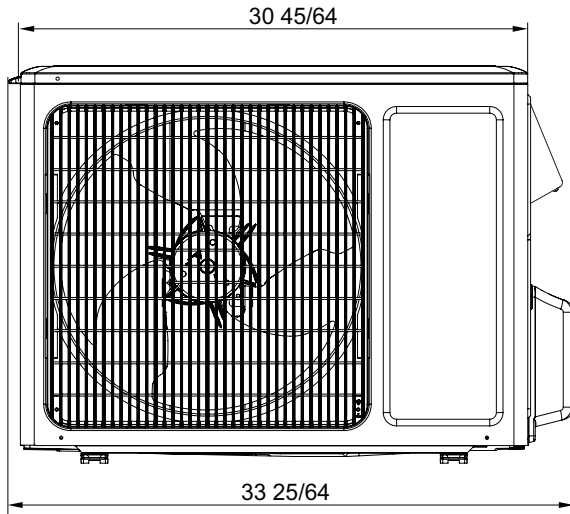

3VIR09HP230V1AO

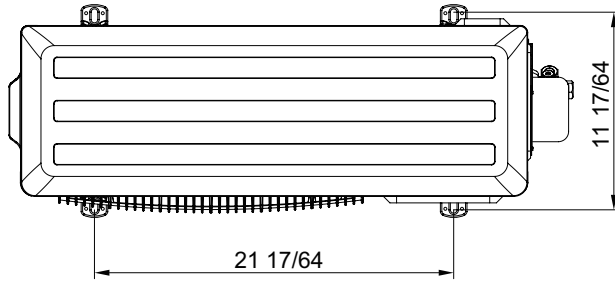
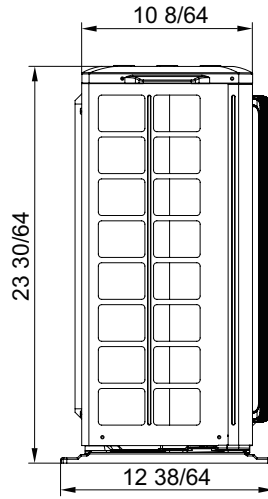

Unit:inch

3VIR12HP115V1AO

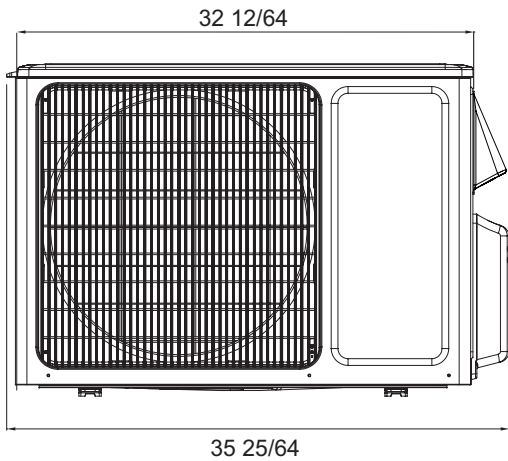

3VIR12HP230V1AO

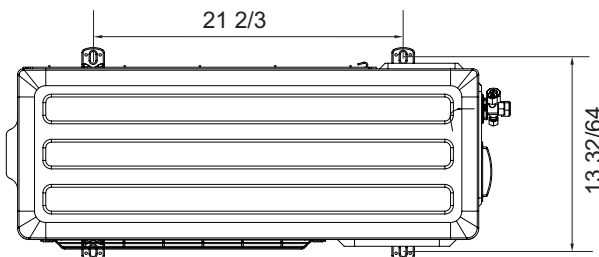
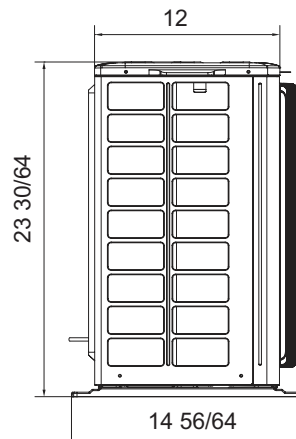

Unit:inch

3. Outline Dimension Diagram

3VIR18HP230V1AO

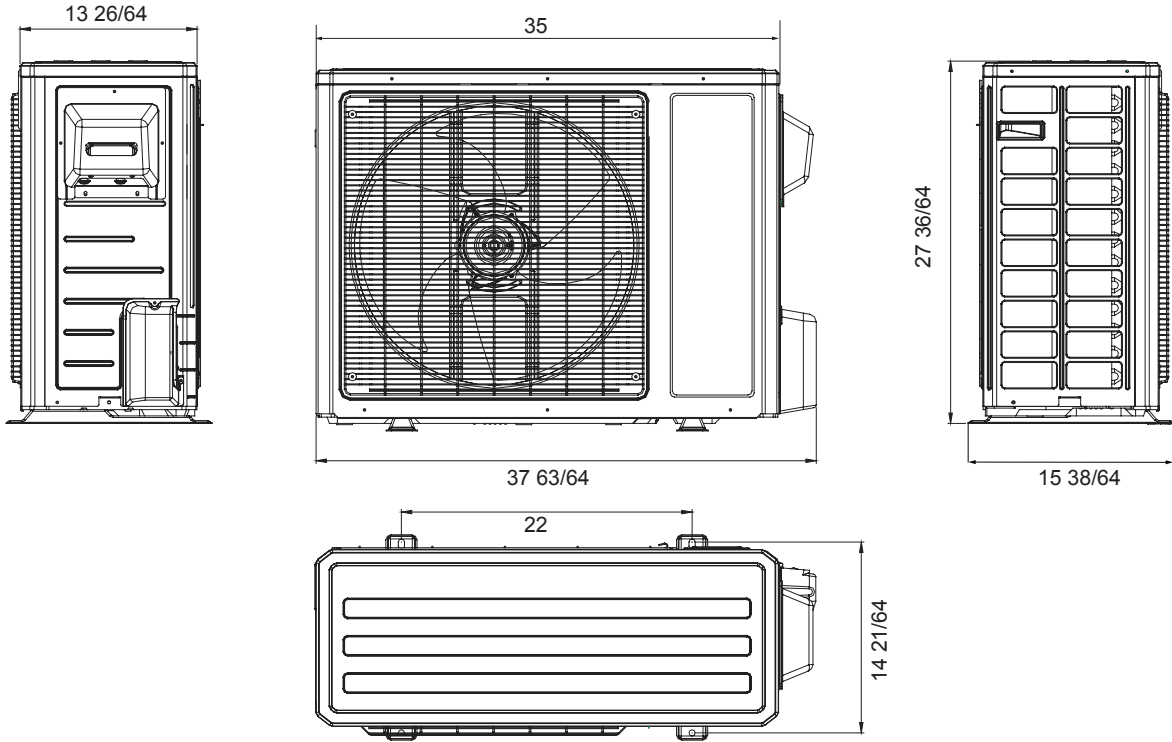

3VIR24HP230V1AO

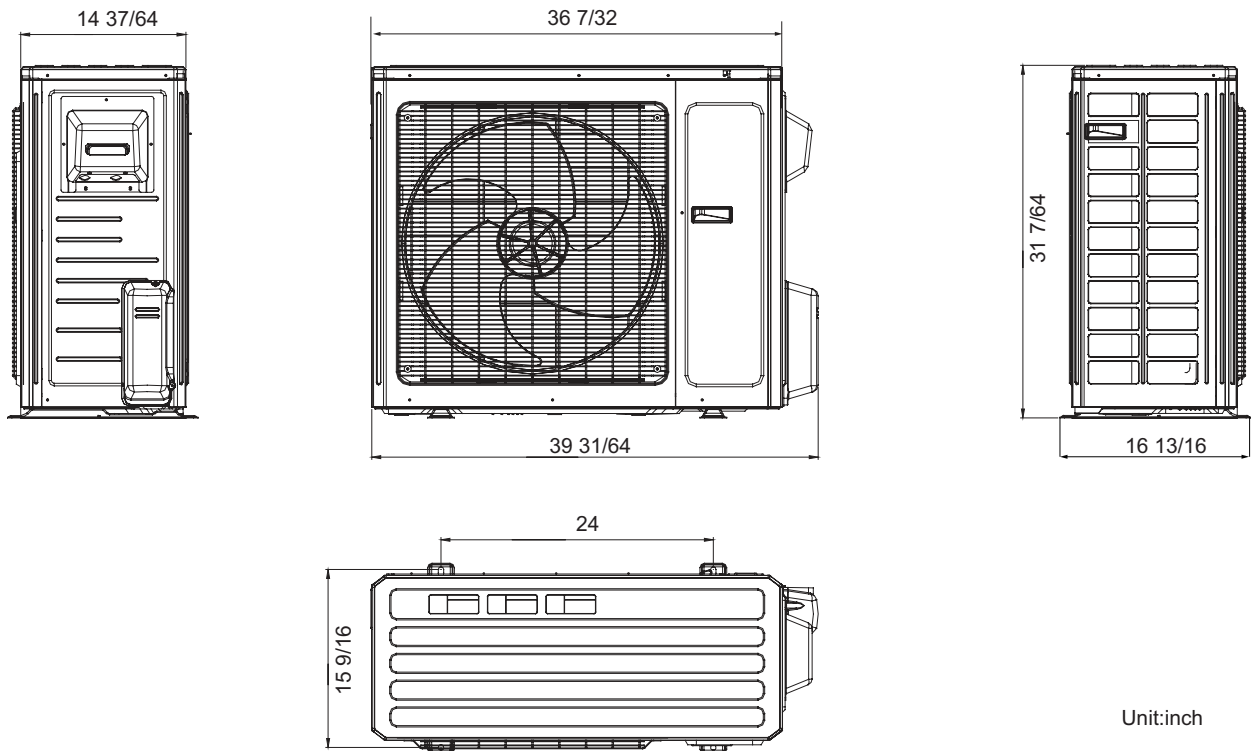

Unit:inch

4. Refrigerant System Diagram

Cooling and heating model

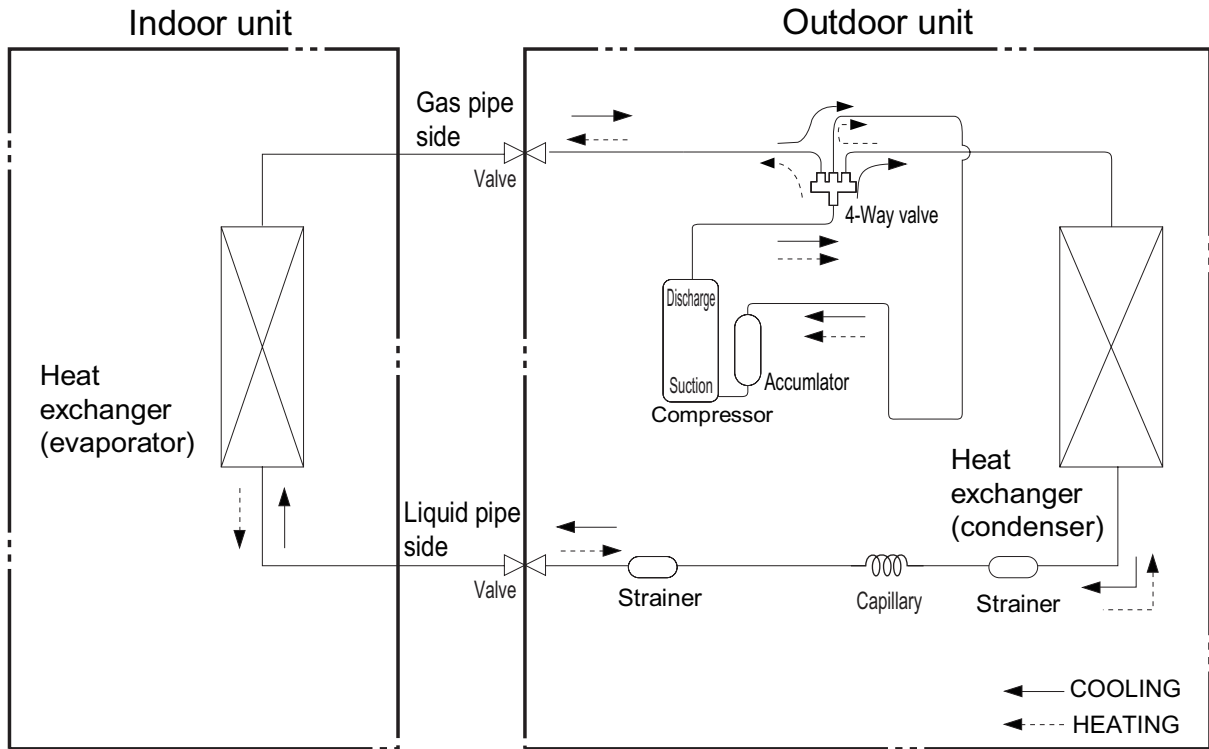

Connection pipe specification:

Liquid pipe: 1/4" (09K & 12K)

Gas pipe: 3/8" (09K)

Gas pipe: 1/2" (12K)

4. Refrigerant System Diagram

Cooling and heating model

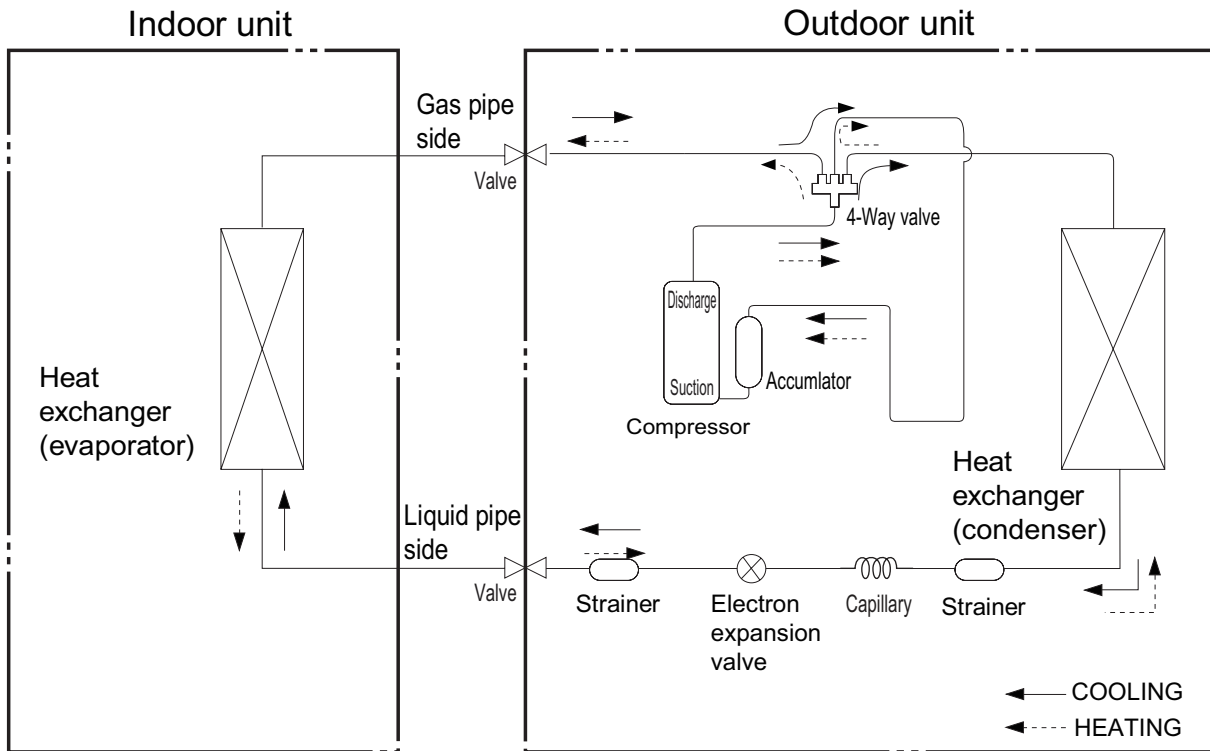

Connection pipe specification:

Liquid pipe: 1/4"

Gas pipe: 5/8" (18K)

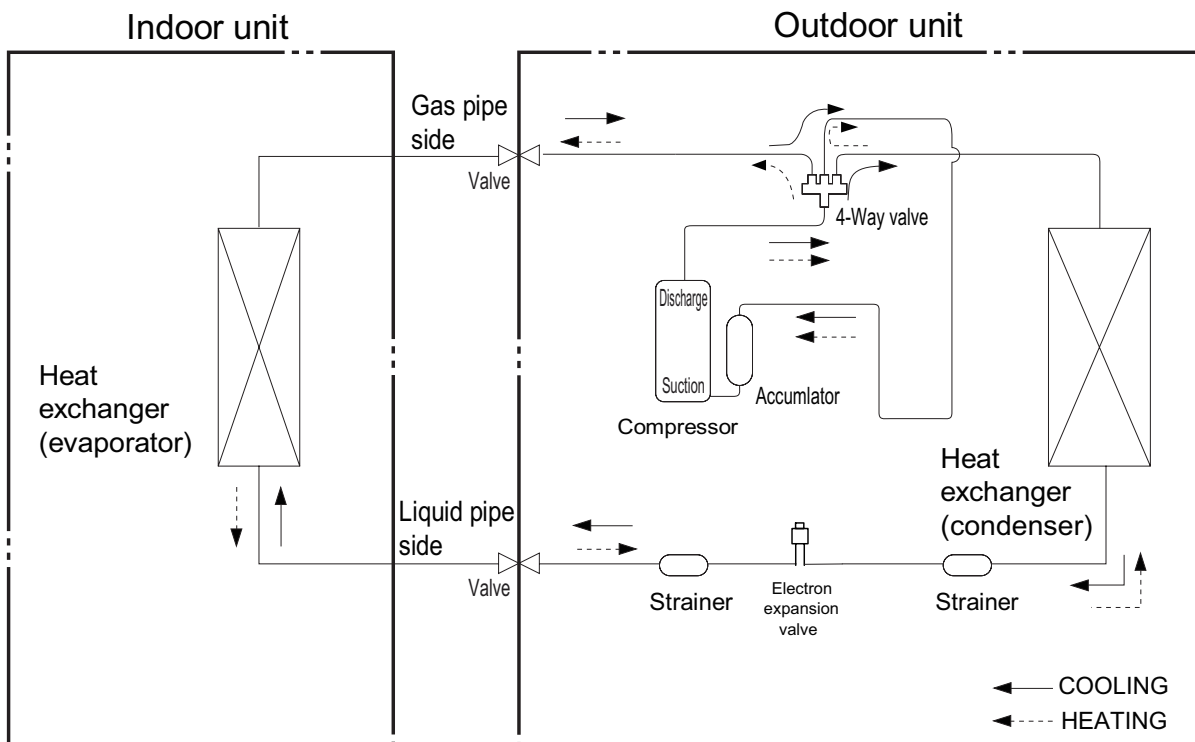

Connection pipe specification:

Liquid pipe: 1/4"

Gas pipe: 5/8" (24K)

5. Electrical Part

5.1 Wiring Diagram

● Instruction

Symbol	Symbol Color	Symbol	Symbol Color	Symbol	Name
WH	White	GN	Green	CAP	Jumper cap
YE	Yellow	BN	Brown	COMP	Compressor
RD	Red	BU	Blue		Grounding wire
YEGN	Yellow/Green	BK	Black	/	/
VT	Violet	OG	Orange	/	/

Note: Jumper cap is used to determine fan speed and the swing angle of horizontal lover for this model.

● Indoor Unit

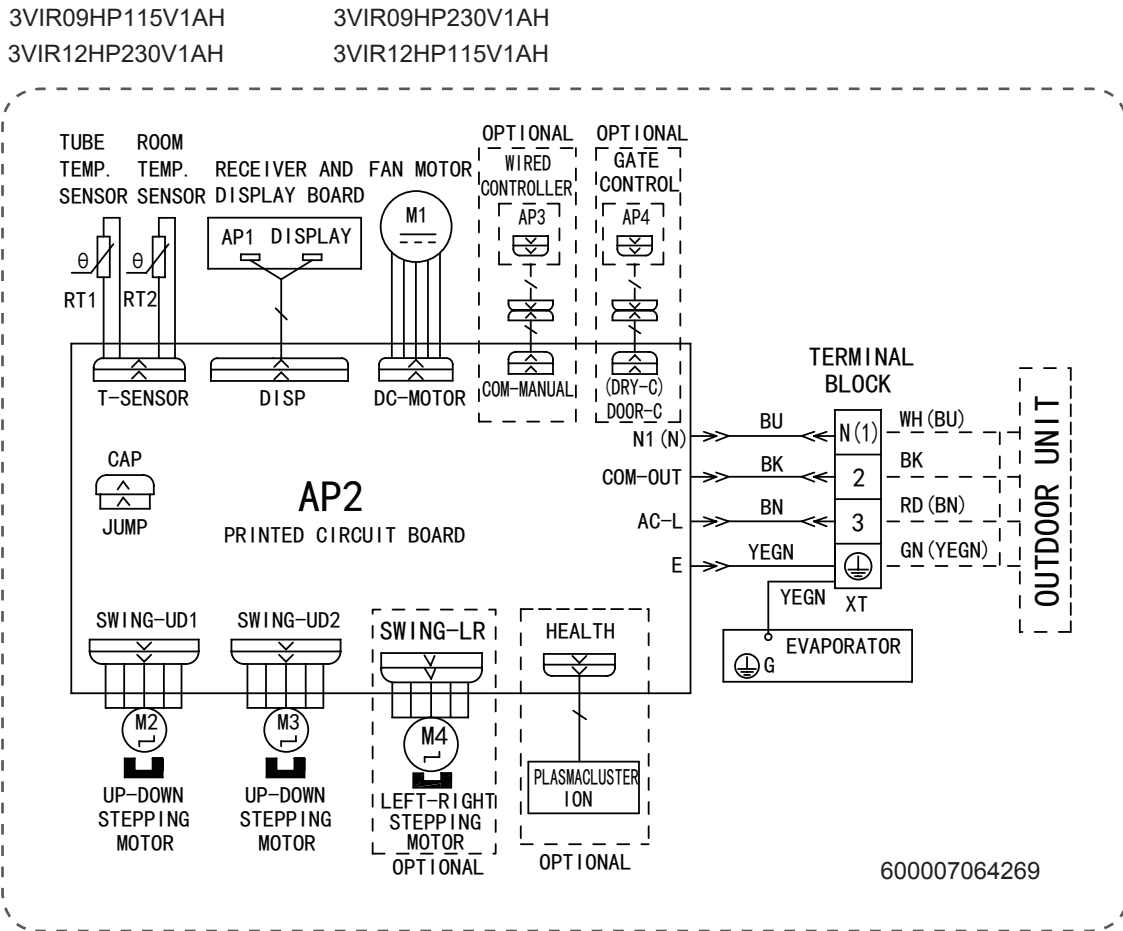

5. Electrical Part

3VIR18HP230V1AH

3VIR24HP230V1AH

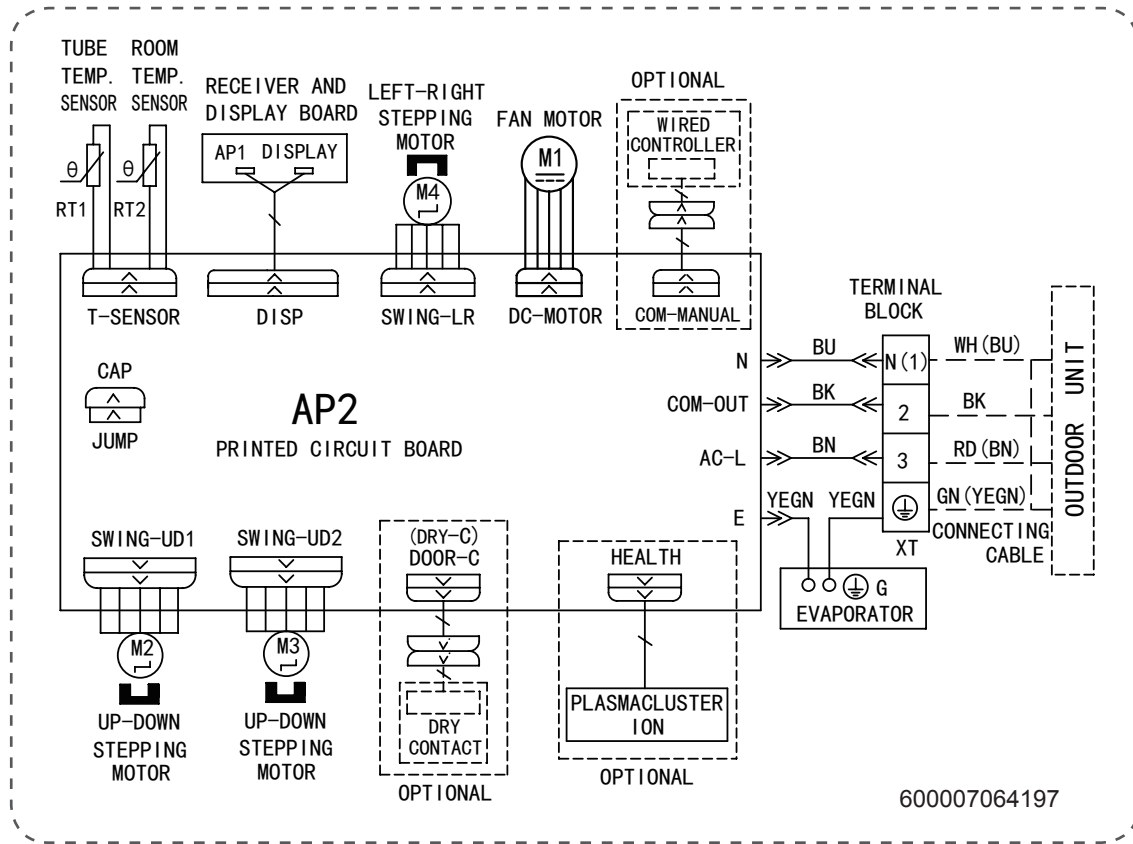

5. Electrical Part

• Outdoor Unit

3VIR09HP230V1AO

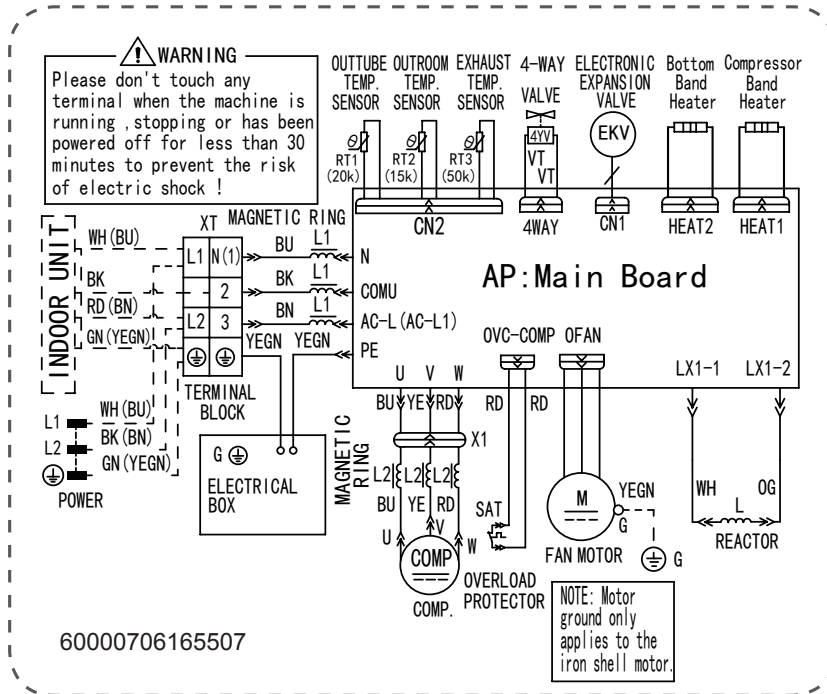

3VIR09HP115V1AO 3VIR12HP115V1AO

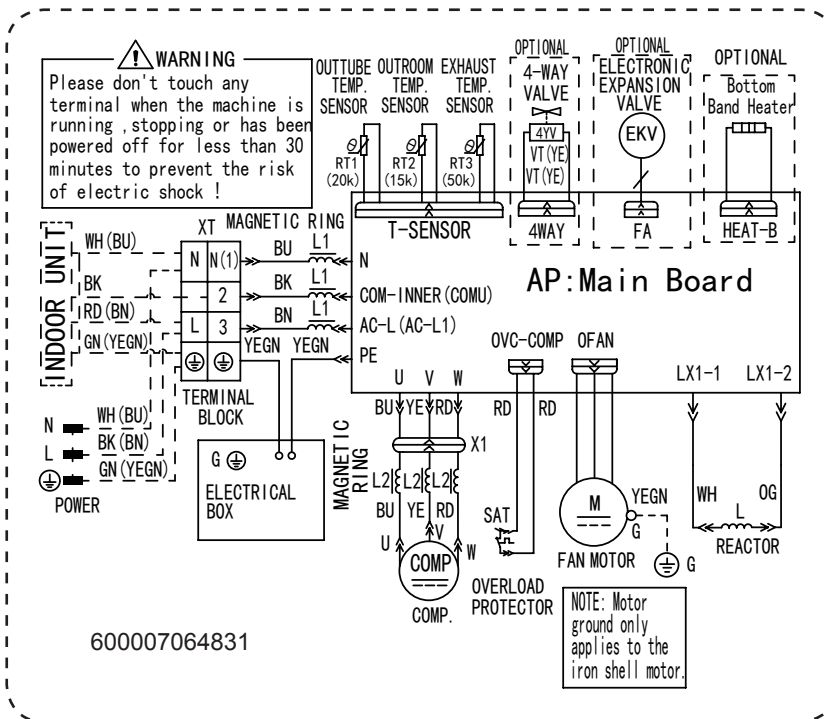

These wiring diagrams are subject to change without notice; please refer to the one supplied with the unit.

5. Electrical Part

3VIR12HP230V1A0

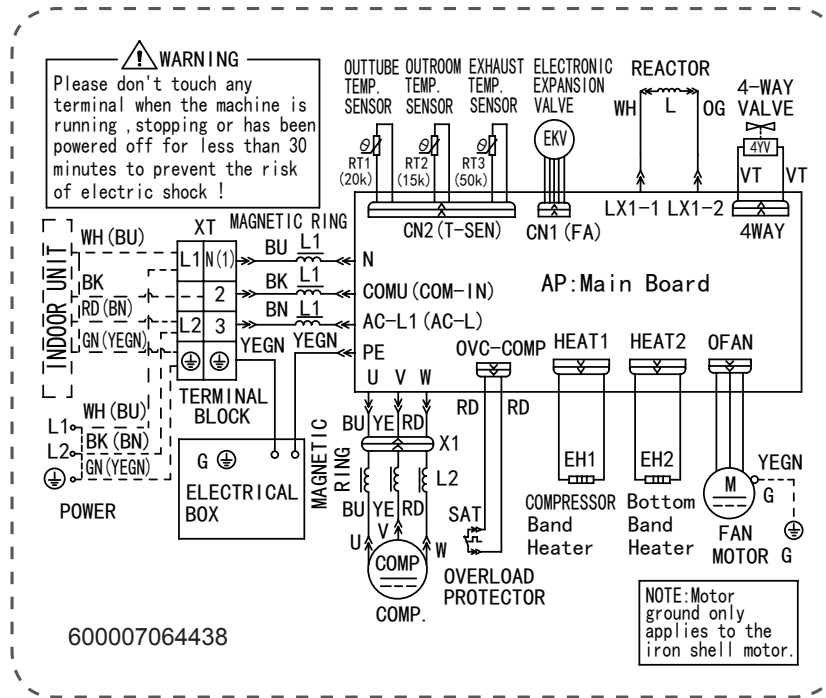

3VIR18HP230V1A0

3VIR24HP230V1A0

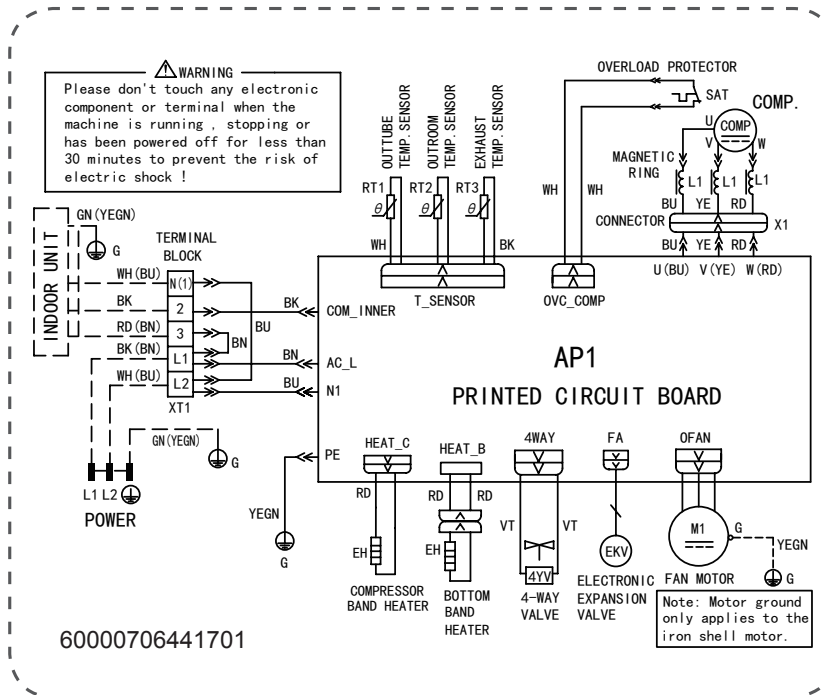

These wiring diagrams are subject to change without notice; please refer to the one supplied with the unit.

5. Electrical Part

5.2 PCB Printed Diagram

Indoor Unit

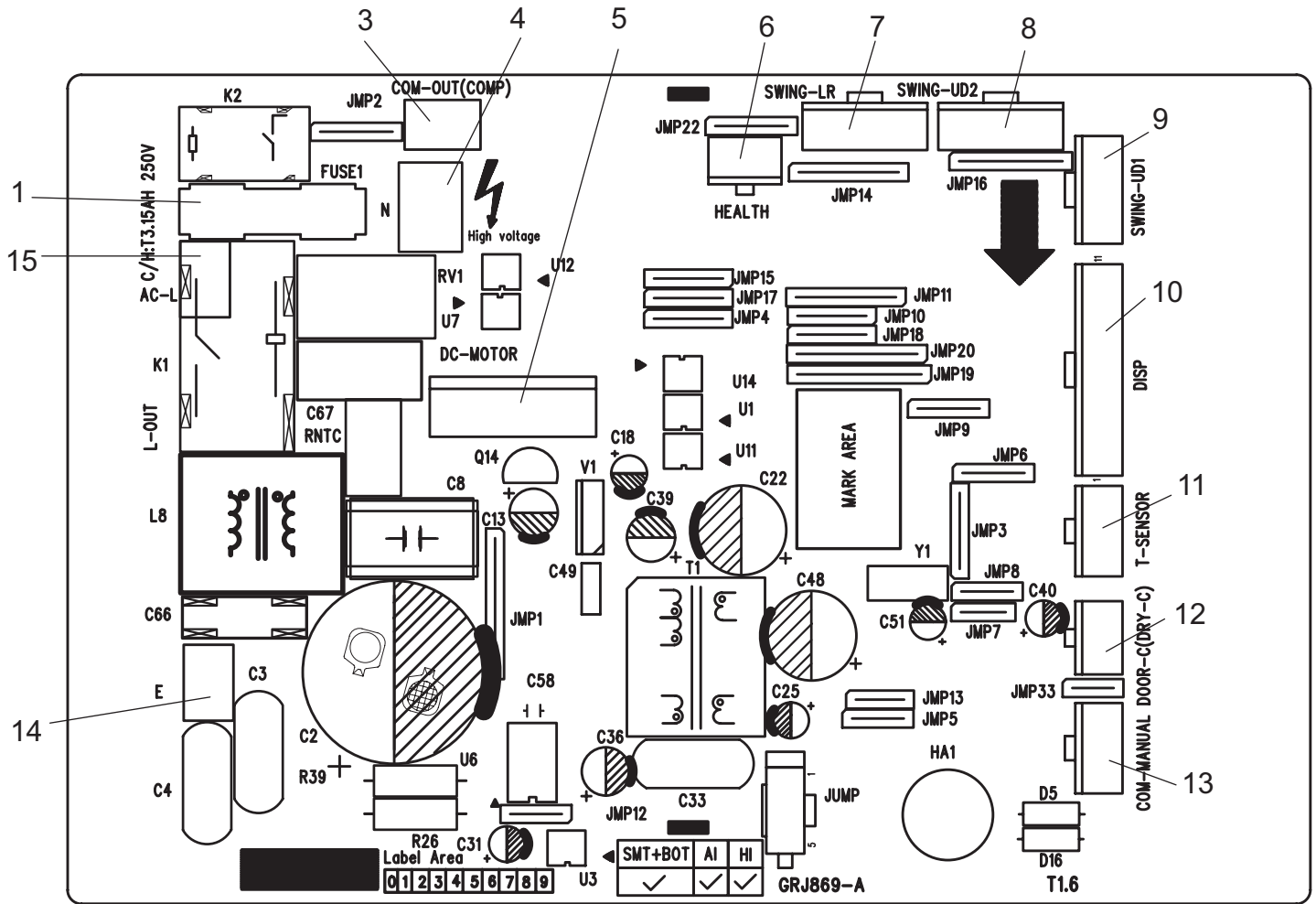

No.	Name	No.	Name
1	Fuse	9	Up&down swing interface 1
2	Live wire	10	Interface of display board
3	Neutral wire	11	Interface of temperature sensor
4	Communication wire	12	Door control
5	DC fan interface	13	Wired controller
6	Interface of cold plasma	14	Earthing wire
7	Left&right swing interface	15	Terminal of live wire
8	Up&down swing interface 2		

5. Electrical Part

3VIR09HP230V1AO 3VIR12HP230V1AO

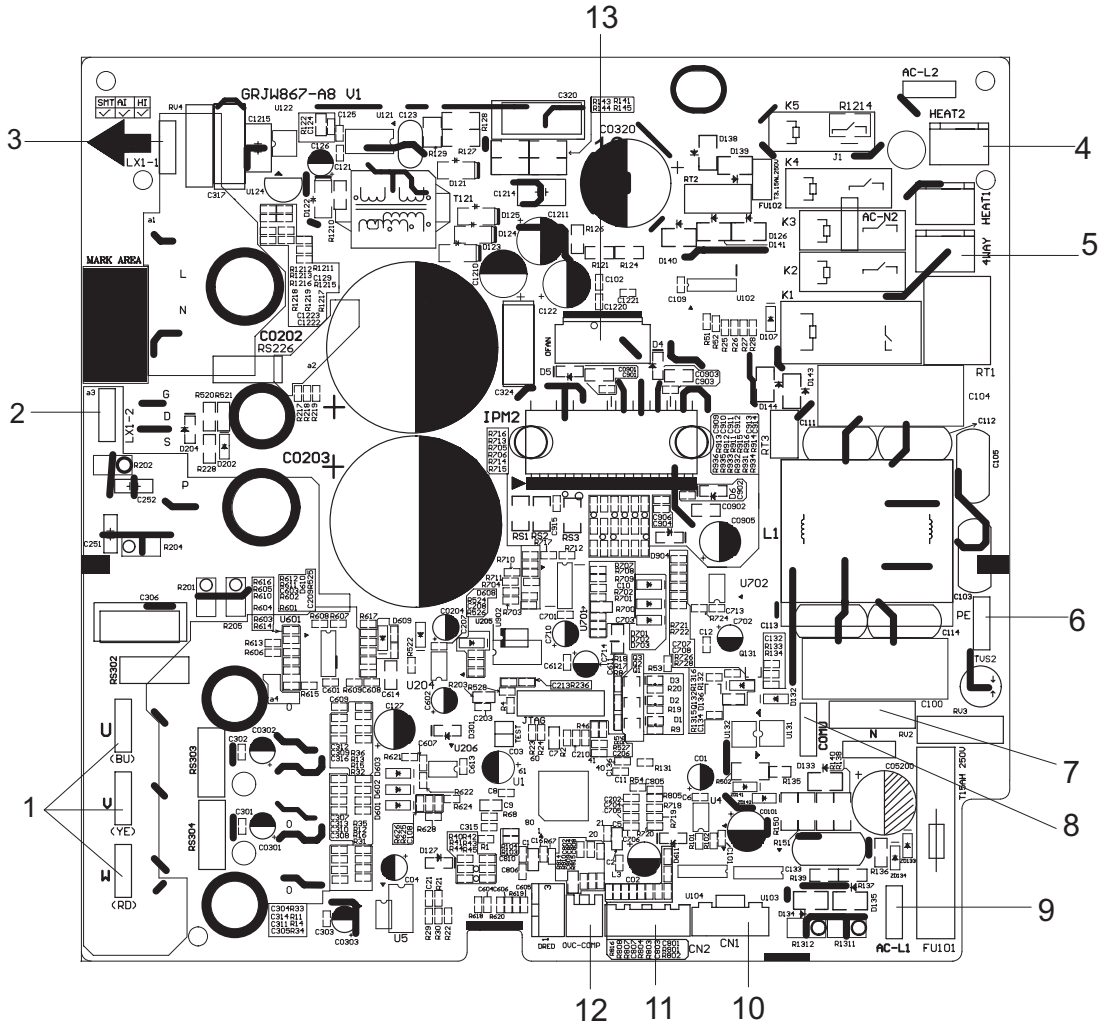

No.	Name
1	Interface of compressor wire
2	Reactor wiring terminal 2
3	Reactor wiring terminal 1
4	Terminal of chassis electric heater
5	4-way valve terminal
6	Grounding wire
7	Neutral wire

No.	Name
8	Communication wire
9	Live wire
10	Terminal of electronic expansion valve
11	Interface of temperature sensor
12	Overload interface of compressor
13	Terminal of outdoor fan

5. Electrical Part

3VIR09HP115V1A0

3VIR12HP115V1A0

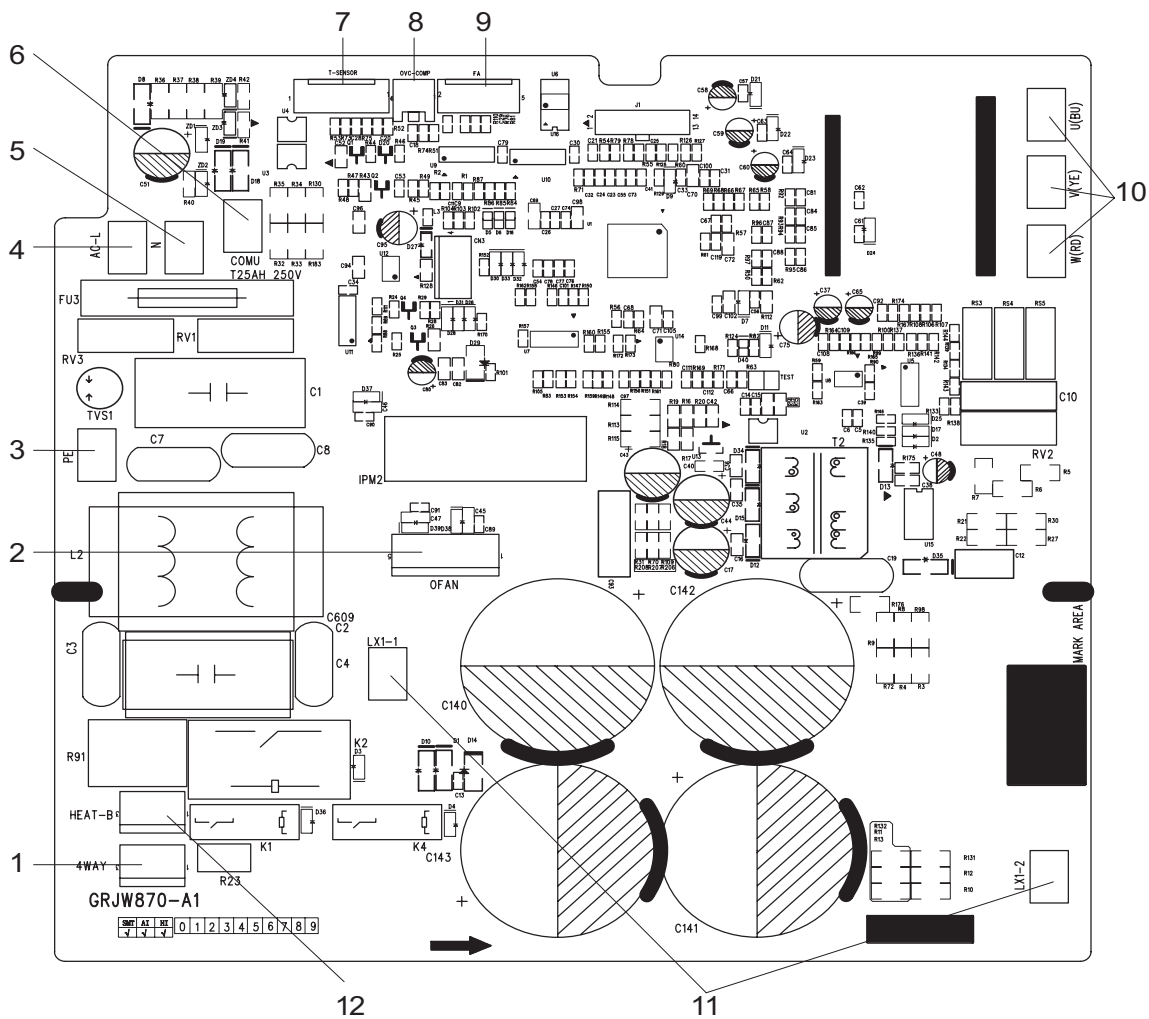

No.	Name
1	4-way valve terminal
2	Terminal of outdoor fan
3	Grounding wire
4	Terminal of power supply live wire
5	Terminal of power supply neutral wire
6	Communication wire

No.	Name
7	Terminal of outdoor unit temperature sensor
8	Compressor overload protection terminal
9	Terminal of electronic expansion valve
10	Compressor wiring terminal
11	Reactor wiring terminal
12	Terminal of electric heating for chassis

5. Electrical Part

3VIR18HP230V1AO 3VIR24HP230V1AO

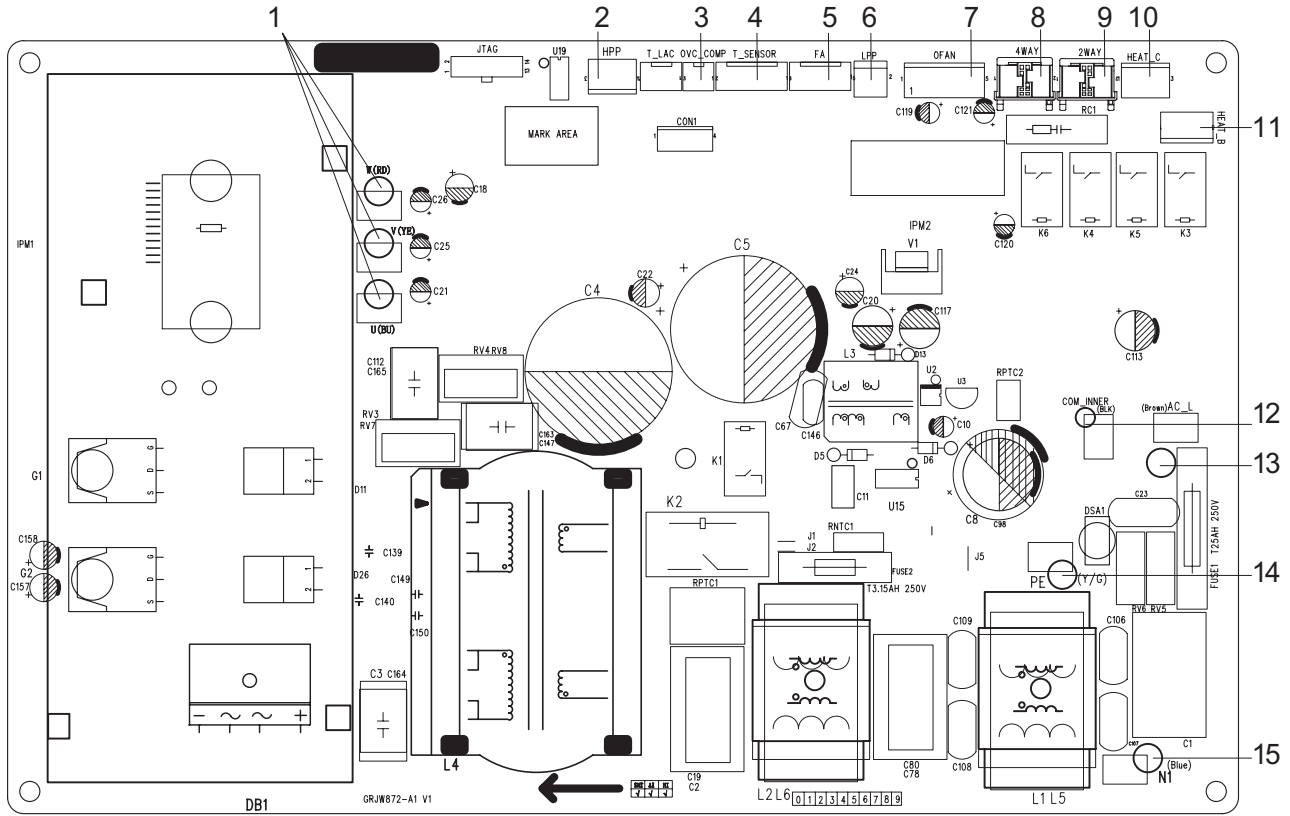



No.	Name
1	Compressor three phase input terminal
2	Terminal of system high pressure protection
3	Compressor overload protection terminal
4	Terminal of temperature sensor
5	Terminal of electronic expansion valve
6	Terminal of system low pressure protection
7	Terminal of fan
8	4-way valve terminal

No.	Name
9	2-way valve terminal
10	Terminal of electric heating for compressor
11	Terminal of electric heating for chassis
12	Communication terminal
13	Terminal of live wire
14	Terminal of earthing wire
15	Terminal of neutral wire







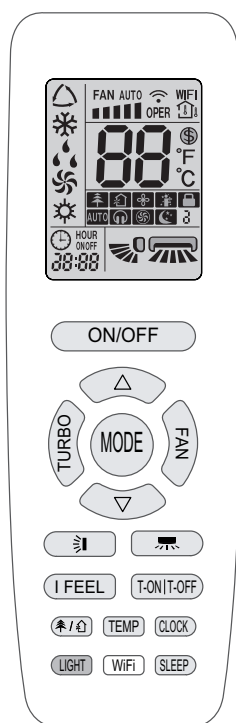

6. Function and Control

6.1 Remote Controller Introduction of YAP1F7F(WiFi)

Notice:

- 1.This is a general use remote controller. It could be used for the air conditioner with multifunction. For the functions which the model doesn't have, if press the corresponding button on the remote controller, the unit will keep the original running status.
- 2.After putting through the power, the air conditioner will give out a sound. Operation indicator "  " is ON (red indicator, the colour is different for different models). After that, you can operate the air conditioner by using remote controller.
- 3.Under on status, pressing the button on the remote controller, the signal icon "  " on the display of remote controller will blink once and the air conditioner will give out a " di " sound, which means the signal has been sent to the air conditioner.
- 4.As for the models with functions of WiFi or wired controller, the indoor unit must have been controlled by standard remote controller under auto mode first, and then the function of adjustable temperature under auto mode can be realized by APP or the wired controller.
- 5.This remote controller can adjust the temperature under auto mode. When matching with the unit which is without the function of adjustable temperature under auto mode, the set temperature under auto mode may be invalid, or the displayed set temperature on the unit is not same as that on the remote controller under auto mode.



- When selecting dry mode, the air conditioner operates at low speed under dry mode. Under dry mode, fan speed can't be adjusted. Press "  " button to adjust fan blowing angle.
- When selecting fan mode, the air conditioner will only blow fan, no cooling and no heating. Press "FAN" button to adjust fan speed. Press "  " button to adjust fan blowing angle. When selecting heat mode, the air conditioner operates under heat mode. Press "  " or "  " button to adjust set temperature. Press "FAN" button to adjust fan speed. Press "  " button to adjust fan blowing angle.
- When selecting heating mode, the air conditioner operates under heat mode. Press "  " or "  " button to adjust set temperature. Press "FAN" button to adjust fan speed. Press "  " / "  " button to adjust fan blowing angle. (Cooling only unit won't receive heating mode signal. If setting heat mode with remote controller, press ON/OFF button can't start up the unit).

Notice:

- For preventing cold air, after starting up heat mode, indoor unit will delay 1~5 minutes to blow air (Actual delay time depends on indoor ambient temperature).
- Set temperature range from remote controller: 16~30°C(61-86°F).
- Under auto mode, temperature can be displayed; Under auto mode, set temperature can be adjusted.
- This mode indicator is not available for some models.





ON/OFF button

Press this button to turn on the unit. Press this button again to turn off the unit.





MODE button

Press this button to select your required operation mode :



- When selecting auto mode, air conditioner will operate automatically according to the sensed temperature. Set temperature can be adjusted and will be displayed as well. Press "FAN" button can adjust fan speed. Press "  " button can adjust fan blowing angle.
- After selecting cool mode, air conditioner will operate under cool mode. Press "  " or "  " button to adjust set temperature. Press "FAN" button to adjust fan speed. Press "  " button to adjust fan blowing angle.

FAN button

This button is used for setting Fan Speed in the sequence that goes from AUTO,  ,  ,  ,  ,  ,  , then back to Auto.



*Note:

- Under AUTO speed, air conditioner will select proper fan speed automatically according to factory default setting.
- It's low fan speed under dry mode.
- X-FAN function Hold fan speed button for 2s in cool or dry mode, the icon "  " is displayed and the indoor fan will continue operation for a few minutes in order to dry the indoor unit even though you have turned off the unit. After energization, X-FAN OFF is defaulted. X-FAN is not available in auto, fan or heat mode.
- This function indicates that moisture on evaporator of indoor unit will be blown after the unit is stopped to avoid mould.
- Having set X-FAN function on: After turning off the unit







6. Function and Control

by pressing " ON/OFF " button indoor fan will continue running for a few minutes. at low speed. In this period, Hold fan speed button for 2s to stop indoor fan directly. Having set X-FAN function off: After turning off the unit by pressing " " button, the complete unit will be off directly.

Turbo button

Under COOL or HEAT mode, press this button to turn to quick COOL or quick HEAT mode. "  " icon is displayed on remote controller. Press this button again to exit turbo function and "  " icon will disappear. If start this function, the unit will run at super-high fan speed to cool or heat quickly so that the ambient temperature approaches the preset temperature as soon as possible.

button



- Press "  " or "  " button once increase or decrease set temperature 1°C (°F). Holding "  " or "  " button, 2s later, set temperature on remote controller will change quickly. On releasing button after setting is finished, temperature indicator on indoor unit will change accordingly.
- When setting T-ON, T-OFF or CLOCK, press "  " or "  " button to adjust time. (Refer to CLOCK, TON, T-OFF buttons)

button

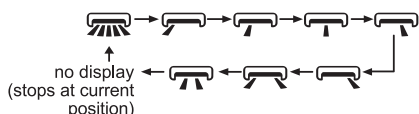
Press this button can select left & right swing angle. Fan blow angle can be selected circularly as below:





Notice:

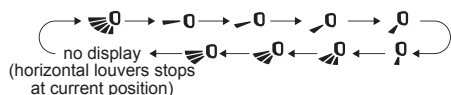

- Press this button continuously more than 2s, the main unit will swing back and forth from left to right, and then loosen the button, the unit will stop swinging and present position of guide louver will be kept immediately.
- Under left and right swing mode, when the status is switched from off to , if press this button again 2s later,  status will switch to off status directly; if press this button again within 2s, the change of swing status will also depend on the circulation sequence stated above.
- The function is only available for some models.

button



Press this button can select left & right swing angle. Fan blow angle can be selected circularly as below:



- When selecting "  ", air conditioner is blowing fan automatically. Horizontal louver will automatically swing up & down at maximum angle.
- When selecting "  ", air conditioner is blowing fan at fixed position. Horizontal louver will stop at the fixed position.









- When selecting "  ", air conditioner is blowing fan at fixed angle. Horizontal louver will send air at the fixed angle.
- Hold "  " button above 2s to set your required swing angle. When reaching your required angle, release the button.

Notice:









- "  " may not be available. When air conditioner receives this signal, the air conditioner will blow fan automatically.
- Press this button continuously for more than 2s, the main unit will swing back and forth from up to down, and then loosen the button, the unit present position of guide louver will be kept immediately.
- Under up and down swing mode, when the status is switched from off to , if press this button again 2s later,  status will switch to off status directly; if press this button again within 2s, the change of swing status will also depend on the circulation sequence stated above.

T-ON|T-OFF button

- T-ON button

"T-ON" button can set the time for timer on. After pressing this button, "  " icon disappears and the word "ON" on remote controller blinks. Press "  " or "  " button to adjust T-ON setting. After each pressing "  " or "  " button, T-ON setting will increase or decrease 1min. Hold "  " or "  " button, 2s later, the time will change quickly until reaching your required time. Press "T-ON" to confirm it. The word "ON" will stop blinking. "  " icon resumes displaying. Cancel T-ON: Under the condition that T-ON is started up, press "T-ON " button to cancel it.

- T-OFF button

"T-OFF" button can set the time for timer off. After pressing this button, "  " icon disappears and the word "OFF" on remote controller blinks. Press "  " or "  " button to adjust T-OFF setting. After each pressing "  " or "  " button, T-OFF setting will increase or decrease 1min. Hold "  " or "  " button, 2s later, the time will change quickly until reaching your required time. Press "T-OFF" word "OFF" will stop blinking. "  " icon resumes displaying. Cancel T-OFF. Under the condition that T-OFF is started up, press "T-OFF" button to cancel it.

Notice:

- Under on and off status, you can set T-OFF or T-ON simultaneously.
- Before setting T-ON or T-OFF, please adjust the clock time.
- After starting up T-ON or T-OFF, set the constant circulating valid.
- After that, air conditioner will be turned on or turned off according to setting time. ON/OFF button has no effect on setting. If you don't need this function, please use remote controller to cancel it.

I FEEL button

Press this button to start I FEEL function and "  " will be displayed on the remote controller. After this function is set, the remote controller will send the detected ambient temperature to the controller and the unit will automatically adjust the indoor temperature according to the detected temperature. Press this

6. Function and Control

button again to cancel I FEEL function and "⌘" will disappear.

- Please put the remote controller near user when this function is set. Do not put the remote controller near the object of high temperature or low temperature in order to avoid detecting inaccurate ambient temperature.

When I FEEL function is turned on, the remote controller should be put within the area where indoor unit can receive the signal sent by the remote controller.

CLOCK button

Press this button to set clock time. "⌚" icon on remote controller will blink. Press "▲" or "▼" button within 5s to set clock time. Each pressing of "▲" or "▼" button, clock time will increase or decrease 1 minute. If hold "▲" or "▼" button, 2s later, time will change quickly. Release this button when reaching your required time. Press "CLOCK" button to confirm the time. "⌚" icon stops blinking.

Notice:

- Clock time adopts 24-hour mode.
- The interval between two operations can't exceed 5s.

Otherwise, remote controller will quit setting status. Operation for TIMER ON/TIMER OFF is the same.

SLEEP button

- Press this button, can select Sleep 1 (☾ 1), Sleep 2 (☾ 2), Sleep 3 (☾ 3) and cancel the Sleep, circulate between these, after electrified, Sleep Cancel is defaulted.

- Sleep 1 is Sleep mode 1, in Cool modes; sleep status after run for one hour, the main unit setting temperature will increase 1, two hours, setting temperature increased 2°C, then the unit will run at this setting temperature; In Heat mode: sleep status after run for one hour, the setting temperature will decrease 1, two hours, setting temperature will decrease 2, then the unit will run at this setting temperature.

- Sleep 2 is sleep mode 2, that is air conditioner will run according to the presetting a group of sleep temperature curve.

- Sleep 3-the sleep curve setting under Sleep mode by DIY;
(1) Under Sleep 3 mode, press "Turbo" button for a long time, remote controller enters into user individuation sleep setting status, at this time, the time of remote controller will display "1hour", the setting temperature "88" will display the corresponding temperature of last setting sleep curve and blink (The first entering will display according to the initial curve setting value of original factory);

- (2) Adjust "+" and "-" button, could change the corresponding setting temperature, after adjusted, press "Turbo" button for confirmation;

- (3) At this time, 1hour will be automatically increased at the timer position on the remote control, (that are "2hours" or "3hours" or "8hours"), the place of setting temperature "88" will display the corresponding temperature of last setting sleep curve and blink;

- (4) Repeat the above step (2)~(3) operation, until 8 hours temperature setting finished, sleep, curve setting finished, at this time, the remote controller will resume the original timer display; temperature display will resume to original setting temperature.

- Sleep3- the sleep curve setting under Sleep mode by DIY could be inquired:

The user could accord to sleep curve setting method to inquire the presetting sleep curve, enter into user individuation sleep setting status, but do not change the temperature, press "Turbo" button directly for confirmation. Note: In the above presetting or enquiry procedure, if continuously within 10s, there is no button pressed, the sleep curve setting within 10s, there is no button pressed, the sleep curve setting status will be automatically quit and resume to display the original displaying. In the presetting or enquiry procedure, press "ON/OFF" button, "Mode" button, "Sleep" button, the sleep curve setting or enquiry status will quit similarly.

WiFi button

Press "WiFi" button to turn on WiFi function, "WiFi" icon will be displayed on the remote controller; Hold "WiFi" button for 5s to turn off WiFi function and "WiFi" icon will disappear. Under off status, press "MODE" and "WiFi" buttons simultaneously for 1s, WiFi module will restore factory settings.

- This function is only available for some models.

🏠/🏡 button

Press this button to achieve the on and off of health and scavenging functions in operation station. Press this button for the first time to start scavenging function; LCD displays "🏠". Press the button for the second time to start health and scavenging functions simultaneously; LCD displays "🏠" and "🏡". Press this button for the third time to quit health and scavenging functions simultaneously. Press the button for the fourth time to start health function; LCD display "🏡". Press this button again to repeat the operation above.

- This function is applicable to partial of models.

LIGHT button

Press this button to turn off display light on indoor unit. "💡" icon on remote controller disappears.

Press this button again to turn on display light. "💡" icon is displayed.

TEMP button

Press this button, you can see indoor set temperature, indoor ambient temperature on indoor unit's display. The setting on remote controller is selected circularly as below:

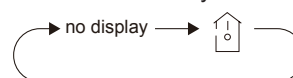

6. Function and Control

Introduction for icons on display screen

	I feel	
	Set fan speed	
	Turbo mode	
	Send signal	
Operation mode		Auto mode
		Cool mode
		Dry mode
		Fan mode
		Heat mode
		Sleep mode
	8°C heating function	
	Health mode	
	Scavenging function	
	Quiet	
	X-FAN function	
Temp. display type		Set temp.
		Indoor ambient temp.
		Outdoor ambient temp.
	Clock	
	Set temperature	
	WiFi function	
	Set time	
	TIMER ON / TIMER OFF	
	Left & right swing	
	Up & down swing	
	Child lock	

Function introduction for combination buttons

Energy-saving function

Under cooling mode, press "TEMP" and "CLOCK" buttons simultaneously to start up or turn off energysaving function. When energy-saving function is started up, "SE" will be shown on remote controller, and air conditioner will adjust the set temperature automatically according to ex-factory setting to reach to the best energy-saving effect.

Press "TEMP" and "CLOCK" buttons simultaneously again to exit energysaving function.

Notice

- Under energy-saving function, fan speed is defaulted at auto speed and it can't be adjusted.
- Under energy-saving function, set temperature can't be adjusted. Press "TURBO" button and the remote controller won't send signal.
- Sleep function and energy-saving function can't operate at the same time. If energy-saving function has been set under cool mode, press sleep button will cancel energy-saving function. If sleep function has been set under cool mode, start up the energy-saving function will cancel sleep function.

8°C heating function

Under heat mode, press "TEMP" and "CLOCK" buttons simultaneously to start up or turn off 8°C heating function. When

this function is started up, "8°C" and "8°C" will be shown on remote controller, and the air conditioner keep the heating status at 8°C. Press "TEMP" and "CLOCK" buttons simultaneously again to exit 8°C heating function.

Notice

- Under 8°C heating function, fan speed is defaulted at auto speed and it can't be adjusted.
- Under 8°C heating function, set temperature can't be adjusted. Press "TURBO" button and the remote controller won't send signal.
- Sleep function and 8°C heating function can't operate at the same time. If 8°C heating function has been set under heat mode, press sleep button will cancel 8°C heating function. If sleep function has been set under heat mode, start up the 8°C heating function will cancel sleep function.
- Under °F temperature display, the remote controller will display 46°F heating.

Child lock function

Press "▲" and "▼" simultaneously to turn on or turn off child lock function. When child lock function is on, "🔒" icon is displayed on remote controller. If you operate the remote controller, the "🔒" icon will blink three times without sending signal to the unit.

Temperature display switchover function

Under OFF status, press "▼" and "MODE" buttons simultaneously to switch temperature display between °C and °F.

Auto clean function

Under unit off status, hold "Mode" and "Fan" buttons simultaneously for 5s to turn on or turn off the auto clean function. When the auto clean function is turned on, indoor unit displays "CL". During the auto clean process of evaporator, the unit will perform fast cooling or fast heating. There may be some noise, which is the sound of flowing liquid or thermal expansion or cold shrinkage. The air conditioner may blow cool or warm air, which is a normal phenomenon. During cleaning process, please make sure the room is well ventilated to avoid affecting the comfort.

Notice

- The auto clean function can only work under normal ambient temperature. If the room is dusty, clean it once a month; if not, clean it once every three months. After the auto clean function is turned on, you can leave the room. When auto clean is finished, the air conditioner will enter standby status.
- This function is only available for some models.

Replacement of batteries in remote controller

1. Lift the cover along the direction of arrow (as shown in Fig 1 ①).
2. Take out the original batteries (as shown in Fig 1 ②).
3. Place two 7# (AAA 1.5V) dry batteries, and make sure the position of "+" polar and "-" polar is correct (as shown in Fig 2 ③).
4. Reinstall the cover (as shown in Fig 2 ④).

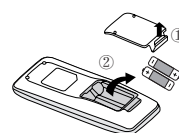

Fig.1

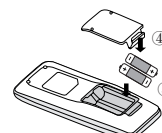

Fig.2

6. Function and Control

NOTICE:

- During operation, point the remote control signal sender at the receiving window on indoor unit.
- The distance between signal sender and receiving window should be no more than 8m, and there should be no obstacles between them.
- Signal may be interfered easily in the room where there is fluorescent lamp or wireless telephone; remote controller should be close to indoor unit during operation.
- Replace new batteries of the same model when replacement is required.
- When you don't use remote controller for a long time, please take out the batteries.
- If the display on remote controller is fuzzy or there's no display, please replace batteries.

Emergency operation

If remote controller is lost or damaged, please use aux. button to turn on or turn off the air conditioner. The operation in details is as below: As shown in the figure, open panel and press aux.button to turn off the air conditioner. When the air conditioner is turned on, it will operate under auto mode.

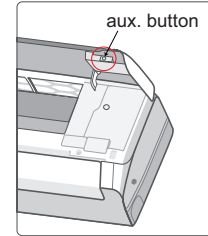

6. Function and Control

6.2 GREE+ App Operation Manual

Control Flow Chart

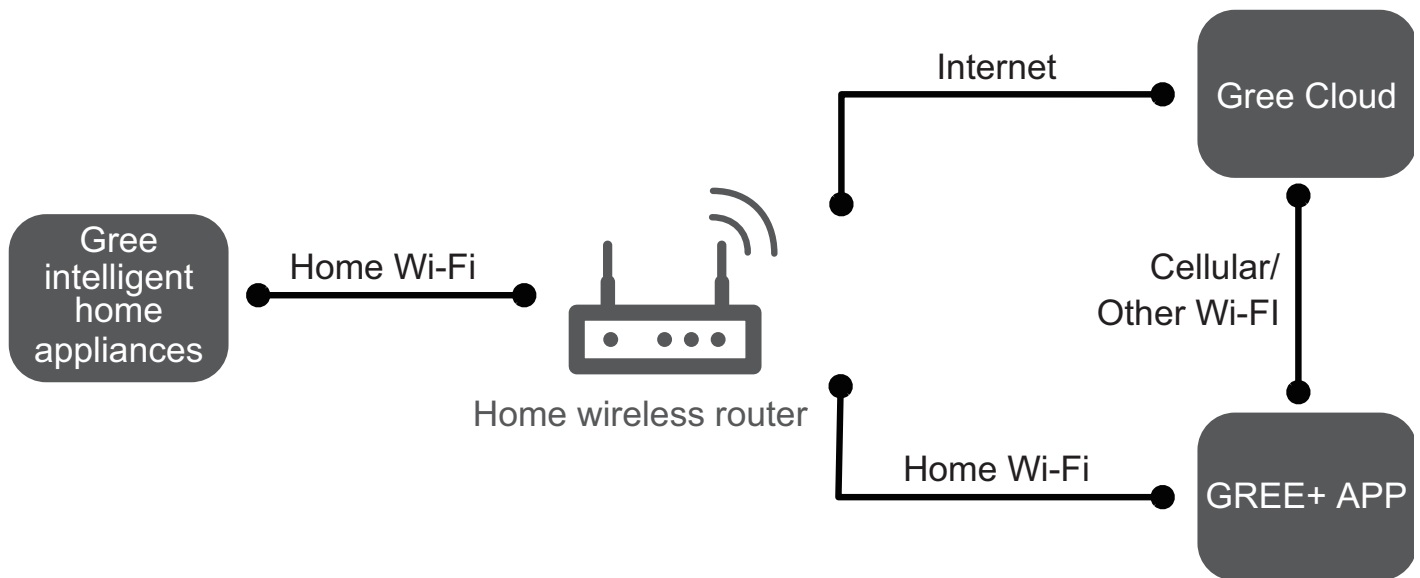

Operating Systems

Requirement for User's smart phone:



iOS system
Support iOS7.0 and
above version



Android system
Support Android 4.4 and
above version

Download and installation



GREE+ App Download Linkage

Scan the QR code or search "GREE+" in the application market to download and install it. When "GREE+" App is installed, register the account and add the device to achieve long-distance control and LAN control of Gree smart home appliances.

For more information, please refer to "Help" in App.

6. Function and Control

6.3 Ewpe Smart App Operation Manual

Control Flow Chart

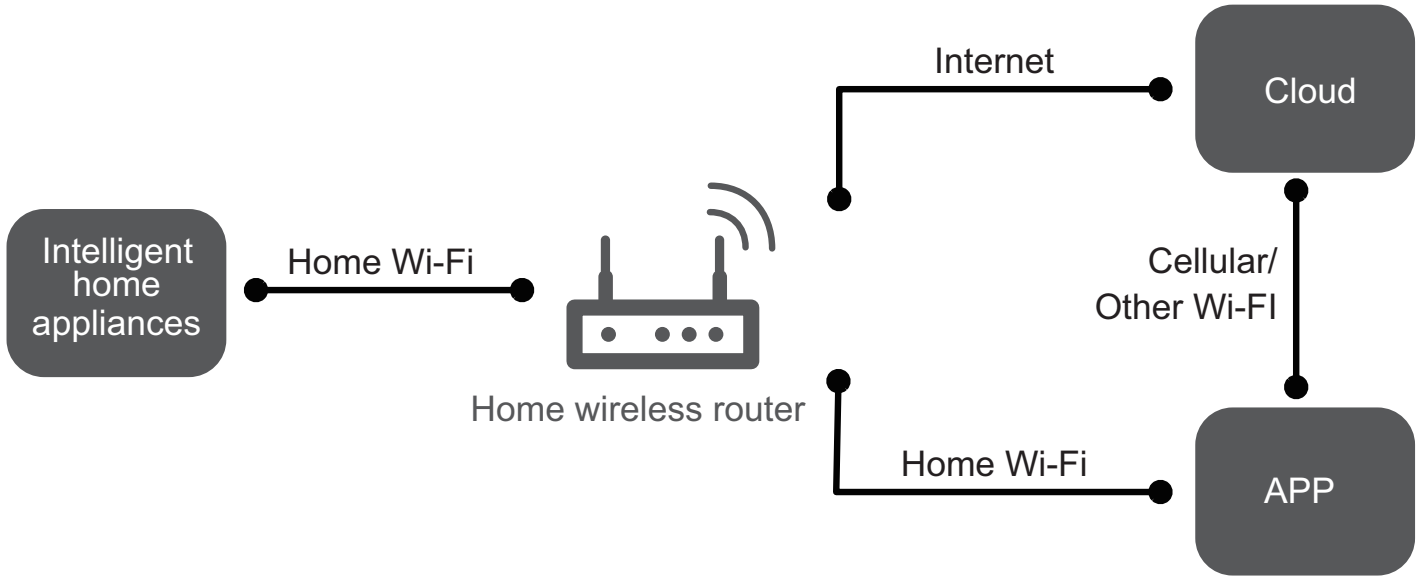

Operating Systems

Requirement for User's smart phone:

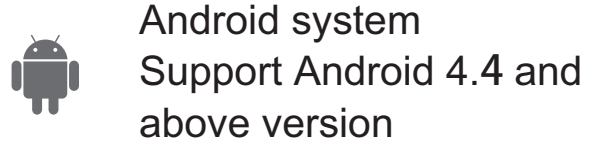
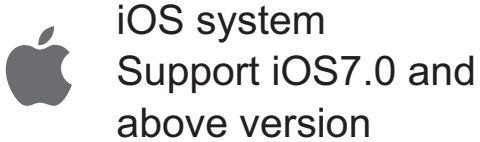

Download and installation



App Download Linkage

Scan the QR code or search "Ewpe Smart" in the application market to download and install it. When "Ewpe Smart" App is installed, register the account and add the device to achieve long-distance control and LAN control of smart home appliances. For more information, please refer to "Help" in App.

6. Function and Control

6.4 Brief Description of Modes and Functions

1. Basic function of system

(1) Cooling mode

(1) Under this mode, fan and swing operates at setting status. Temperature setting range is 16~30°C.

(2) During malfunction of outdoor unit or the unit is stopped because of protection, indoor unit keeps original operation status.

(2) Drying mode

(1) Under this mode, fan operates at low speed and swing operates at setting status. Temperature setting range is 16~30°C.

(2) During malfunction of outdoor unit or the unit is stopped because of protection, indoor unit keeps original operation status.

(3) Protection status is same as that under cooling mode.

(4) Sleep function is not available for drying mode.

(3) Heating mode

(1) Under this mode, Temperature setting range is 16~30°C.

(2) Working condition and process for heating mode:

When turn on the unit under heating mode, indoor unit enters into cold air prevention status. When the unit is stopped or at OFF status, and indoor unit has been started up just now, the unit enters into residual heat-blowing status.

(4) Working method for AUTO mode:

1. Working condition and process for AUTO mode:

a. Under auto mode set temperature can be adjusted. The unit switch mode automatically according to ambient temperature.

2. Protection function

a. During cooling operation, protection function is same as that under cooling mode.

b. During heating operation, protection function is same as that under heating mode.

3. Display: Set temperature is the set value under each condition. Ambient temperature is (Tamb.-Tcompensation) for heat pump unit and Tamb. for cooling only unit.

4. If there's I feel function, Tcompensation is 0. Others are same as above.

(5) Fan mode

Under this mode, indoor fan operates at set fan speed. Compressor, outdoor fan, 4-way valve and electric heating tube stop operation. Indoor fan can select to operate at high, medium, low or auto fan speed. Temperature setting range is 16~30°C.

2. Other control

(1) Buzzer

Upon energization or availablely operating the unit or remote controller, the buzzer will give out a beep.

(2) Auto button

If press this auto button when turning off the unit, the complete unit will operate at auto mode. Indoor fan operates at auto fan speed and swing function is turned on. Press this auto button at ON status to turn off the unit.

(3) Auto fan

Heating mode: During auto heating mode or normal heating mode, auto fan speed will adjust the fan speed automatically according to ambient temperature and set temperature.

(4) Sleep

After setting sleep function for a period of time, system will adjust set temperature automatically.

(5) Timer function:

General timer and clock timer functions are compatible by equipping remote controller with different functions.

(6) Memory function

Memorize compensation temperature, off-peak energization value. Memory content: mode, up&down swing, light, set temperature, set fan speed, general timer (clock timer can't be memorized). After power recovery, the unit will be turned on automatically according to memory content.

(7) Health function

During operation of indoor fan, set health function by remote controller. Turn off the unit will also turn off health function.

Turn on the unit by pressing auto button, and the health is defaulted ON.

(8) I feel control mode

After controller received I feel control signal and ambient temperature sent by remote controller, controller will work according to the ambient temperature sent by remote controller.

(9) Compulsory defrosting function

a. Start up compulsory defrosting function

Under ON status, set heating mode with remote controller and adjust the temperature to 16°C. Press "+, -, +, -, +,-" button successively within 5s and the complete unit will enter into compulsory defrosting status. Meanwhile, heating indicator on indoor unit will ON 10s and OFF 0.5s successively. (Note: If complete unit has malfunction or stops operation due to protection, compulsory defrosting function can be started up after malfunction or protection is resumed.

b. Exit compulsory defrosting mode

After compulsory defrosting is started up, the complete unit will exit defrosting operation according to the actual defrosting result, and the complete unit will resume normal heating operation.

(10) Refrigerant recovery function:

a. Enter refrigerant recycling function

6. Function and Control

Within 5min after energizing (unit ON or OFF status is ok), continuously press LIGHT button for 3 times within 3s to enter refrigerant recycling mode; Fo is displayed and refrigerant recycling function is started. At this moment, the maintenance people closes liquid valve. After 5min, stick the thimble of maintenance valve with a tool. If there is no refrigerant spraying out, close the gas valve immediately and then turn off the unit to remove the connection pipe.

b. Exit refrigerant recycling function

After entering refrigerant recycling mode, when receive any remote control signal or enter refrigerant recycling mode for 25min, the unit will exit refrigerant recycling mode automatically. If the unit is in standby mode before refrigerant recycling, it will be still in standby mode after finishing refrigerant recycling; if the unit is in ON status before refrigerant recycling, it will still run in original operation mode.

(11) Ambient temperature display control mode

a. When user set the remote controller to display set temperature (corresponding remote control code: 01), current set temperature will be displayed.

b. Only when remote control signal is switched to indoor ambient temperature display status (corresponding remote control code: 10) from other display status (corresponding remote control code: 00, 01,11),controller will display indoor ambient temperature for 3s and then turn back to display set temperature.

Under this mode, indoor fan operates at set fan speed. Compressor, outdoor fan, 4-way valve and electric heating tube

stop operation. Indoor fan can select to operate at high, medium, low or auto fan speed. Temperature setting range is 16~30°C.

(12) Off-peak energization function:

Adjust compressors minimum stop time. The original minimum stop time is 180s and then we change to:

The time interval between two start-ups of compressor can't be less than $180+T$ s ($0 \leq T \leq 15$). T is the variable of controller. That's to say the minimum stop time of compressor is 180s~195s. Read-in T into memory chip when refurbish the memory chip each time. After power recovery, compressor can only be started up after $180+T$ s at least.

(13) SE control mode

The unit operates at SE status.

(14) X-fan mode

When X-fan function is turned on, after turn off the unit, indoor fan will still operate at low speed for 2min and then the complete unit will be turned off. When x-fan function is turned off, after turn off the unit, the complete unit will be turned off directly.

(15) 8°C heating function

Under heating mode, you can set 8°C heating function by remote controller. The system will operate at 8°C set temperature.

(16) Turbo fan control function

Set turbo function under cooling or heating mode to enter into turbo fan speed. Press fan speed button to cancel turbo wind.

No turbo function under auto, dry or fan mode.

6. Function and Control

Outdoor Units

1. Cooling mode

Working condition and process of cooling mode:

(1) When $T_{\text{indoor ambient temperature}} \geq T_{\text{preset}}$, unit enters into cooling mode. Indoor fan, outdoor fan and compressor start operation.

Indoor fan operates according to set fan speed.

(2) When $T_{\text{indoor ambient temperature}} \leq T_{\text{preset}} - 2^{\circ}\text{C}$, compressor stops operation and outdoor fan will stop 30s later. Indoor fan operates according to set fan speed.

(3) When $T_{\text{preset}} - 2^{\circ}\text{C} < T_{\text{indoor ambient temperature}} < T_{\text{preset}}$, unit operates according to the previous status.

Under cooling mode, 4-way valve is not energized. Temperature setting range is $16 \sim 30^{\circ}\text{C}$. If compressor stops because of malfunction in cooling mode, indoor fan and swing motor will work according to the original status.

2. Drying mode

(1) Working condition and process of drying mode

a. When $T_{\text{indoor ambient temperature}} > T_{\text{preset}}$, unit will be in drying mode. Outdoor fan and compressor start operation while indoor fan will operate at low fan speed.

b. When $T_{\text{preset}} - 2^{\circ}\text{C} \leq T_{\text{indoor ambient temperature}} \leq T_{\text{preset}}$, unit operates according to the previous status.

c. When $T_{\text{indoor ambient temperature}} < T_{\text{preset}} - 2^{\circ}\text{C}$, compressor stops operation and outdoor fan will stop 30s later.

(2) Under drying mode, 4-way valve is not energized. Temperature setting range is $16 \sim 30^{\circ}\text{C}$.

(3) Protection function: same as in cooling mode.

3. Fan mode

(1) Under this mode, indoor fan can select different fan speed (except Turbo) or auto fan speed. Compressor, outdoor fan and 4-way valve all stop operation.

(2) In fan mode, temperature setting range is $16 \sim 30^{\circ}\text{C}$.

4. Heating mode

Working condition and process of heating mode:

(1) When $T_{\text{preset}} - (T_{\text{indoor ambient temperature}} - T_{\text{compensation}}) \geq 1^{\circ}\text{C}$, unit enters into heating mode. Compressor, outdoor fan and 4-way valve start operation.

(2) When $-2^{\circ}\text{C} < T_{\text{preset}} - (T_{\text{indoor ambient temperature}} - T_{\text{compensation}}) < 1^{\circ}\text{C}$, unit operates according to the previous status.

(3) When $T_{\text{preset}} - (T_{\text{indoor ambient temperature}} - T_{\text{compensation}}) \leq -2^{\circ}\text{C}$, compressor stops operation and outdoor fan will stop 30s later. Indoor fan will be in residual-heat blowing status.

(4) When unit is turned off under heating mode or changed to other modes from heating mode, 4-way valve will be power-off 2min after compressor stops working (compressor is in operation status under heating mode).

(5) When $T_{\text{outdoor ambient temperature}} > 30^{\circ}\text{C}$, compressor stops operation immediately. Outdoor fan will stop 30s later.

(6) Under the condition that compressor is turned on, when unit is changed to heating mode from cooling or drying mode, 4-way valve will be energized in 2~3mins delay.

Note: Tcompensation is determined by IDU and ODU. If IDU controls the compensation temperature, then Tcompensation is determined according to the value sent by IDU to ODU; If IDU does not control the compensation temperature, then Tcompensation will default to 3°C by the ODU.

5. Freon recovery mode

After the Freon recovery signal from IDU is received, cooling at rated frequency will be forcibly turned on to recover Freon.

Indoor unit will display Fo. If any signal from remote controller is received, unit will exit from Freon recovery mode and indoor unit stops displaying Fo.

6. Compulsory defrosting

If unit is turned on under heating mode and set temperature is 16°C (by remote controller), press "+, -, +, -, +, -" within 5s, unit will enter into compulsory defrosting mode and send the signal to ODU. When the compulsory defrosting signal from ODU is received, IDU will exit from the compulsory defrosting mode and stop sending the signal to ODU. After ODU receives the compulsory defrosting code, it will start compulsory defrosting. Defrosting frequency and opening angle will be the same as in normal defrosting mode. When compulsory defrosting is finished, the complete unit resumes original status.

7. Auto mode

Auto mode is determined by controller of IDU. See IDU logic for details.

8. 8°C heating

Set temperature is 8°C . Display board of IDU displays 8°C . Under this mode, "Cold air prevention" function is shielded.

If compressor is operating under this mode, fan speed will adjust according to auto fan speed; if compressor stops operation under this mode, indoor fan will be in residual-heat blowing status.

When power on, communication light will be blinking in a normal way (after receiving a group of correct signals, blinking stops for 0.2s~0.3s). If There's no communication, communication light will be always on. If other ODU has malfunction, communication light will be on for 1s and off for 1s in a circular way.

7. Notes for Installation and Maintenance

Safety Precautions: Important!

Please read the safety precautions carefully before installation and maintenance.

The following contents are very important for installation and maintenance.

Please follow the instructions below.

- The installation or maintenance must accord with the instructions.
- Comply with all national electrical codes and local electrical codes.
- Pay attention to the warnings and cautions in this manual.
- All installation and maintenance shall be performed by distributor or qualified person.
- All electric work must be performed by a licensed technician according to local regulations and the instructions given in this manual.
- Be caution during installation and maintenance. Prohibit incorrect operation to prevent electric shock, casualty and other accidents.

WARNINGS

Electrical Safety Precautions:

1. Cut off the power supply of air conditioner before checking and maintenance.
2. The air condition must apply specialized circuit and prohibit share the same circuit with other appliances.
3. The air conditioner should be installed in suitable location and ensure the power plug is touchable.
4. Make sure each wiring terminal is connected firmly during installation and maintenance.
5. Have the unit adequately grounded. The grounding wire can't be used for other purposes.
6. Must apply protective accessories such as protective boards, cable-cross loop and wire clip.
7. The live wire, neutral wire and grounding wire of power supply must be corresponding to the live wire, neutral wire and grounding wire of the air conditioner.
8. The power cord and power connection wires can't be pressed by hard objects.
9. If power cord or connection wire is broken, it must be replaced by a qualified person.
10. If the power cord or connection wire is not long enough, please get the specialized power cord or connection wire from the manufacture or distributor. Prohibit prolong the wire by yourself.
11. For the air conditioner without plug, an air switch must

be installed in the circuit. The air switch should be all-pole parting and the contact parting distance should be more than 3mm.

12. Make sure all wires and pipes are connected properly and the valves are opened before energizing.
13. Check if there is electric leakage on the unit body. If yes, please eliminate the electric leakage.
14. Replace the fuse with a new one of the same specification if it is burnt down; Don't replace it with a cooper wire or conducting wire.
15. If the unit is to be installed in a humid place, the circuit breaker must be installed.

Installation Safety Precautions:

1. Select the installation location according to the requirement of this manual.(See the requirements in installation part)
2. Handle unit transportation with care; the unit should not be carried by only one person if it is more than 20kg.
3. When installing the indoor unit and outdoor unit, a sufficient fixing bolt must be installed; make sure the installation support is firm.
4. Ware safety belt if the height of working is above 2m.
5. Use equipped components or appointed components during installation.
6. Make sure no foreign objects are left in the unit after finishing installation.

Refrigerant Safety Precautions:

1. When refrigerant leaks or requires discharge during installation, maintenance, or disassembly, it should be handled by certified professionals or otherwise in compliance with local laws and regulations.
2. Avoid contact between refrigerant and fire as it generates poisonous gas; Prohibit prolong the connection pipe by welding.
3. Apply specified refrigerant only. Never have it mixed with any other refrigerant. Never have air remain in the refrigerant line as it may lead to rupture or other hazards.
4. Make sure no refrigerant gas is leaking out when installation is completed.
5. If there is refrigerant leakage, please take sufficient measure to minimize the density of refrigerant.
6. Never touch the refrigerant piping or compressor without wearing glove to avoid scald or frostbite.

Improper installation may lead to fire hazard, explosion, electric shock or injury.

7. Notes for Installation and Maintenance

Safety Precautions for Installing and Relocating the Unit:

To ensure safety, please be mindful of the following precautions.

WARNINGS

1. When installing or relocating the unit, be sure to keep the refrigerant circuit free from air or substances other than the specified refrigerant.

Any presence of air or other foreign substance in the refrigerant circuit will cause system pressure rise or compressor rupture, resulting in injury.

2. When installing or moving this unit, do not charge the refrigerant which is not comply with that on the nameplate or unqualified refrigerant.

Otherwise, it may cause abnormal operation, wrong action, mechanical malfunction or even series safety accident.

3. When refrigerant needs to be recovered during relocating or repairing the unit, be sure that the unit is running in cooling mode. Then, fully close the valve at high pressure side (liquid valve). About 30-40 seconds later, fully close the valve at low pressure side (gas valve), immediately stop the unit and disconnect power. Please note that the time for refrigerant recovery should not exceed 1 minute.

If refrigerant recovery takes too much time, air may be sucked in and cause pressure rise or compressor rupture, resulting in injury.

4. During refrigerant recovery, make sure that liquid valve and gas valve are fully closed and power is disconnected before detaching the connection pipe.

If compressor starts running when stop valve is open and connection pipe is not yet connected, air will be sucked in and cause pressure rise or compressor rupture, resulting in injury.

5. When installing the unit, make sure that connection pipe is securely connected before the compressor starts running.

If compressor starts running when stop valve is open and connection pipe is not yet connected, air will be sucked in and cause pressure rise or compressor rupture, resulting in injury.

6. Prohibit installing the unit at the place where there may be leaked corrosive gas or flammable gas.

If there leaked gas around the unit, it may cause explosion and other accidents.

7. Do not use extension cords for electrical connections. If the electric wire is not long enough, please contact a local service center authorized and ask for a proper electric wire.

Poor connections may lead to electric shock or fire.

8. Use the specified types of wires for electrical connections between the indoor and outdoor units. Firmly clamp the wires so that their terminals receive no external stresses.

Electric wires with insufficient capacity, wrong wire connections and insecure wire terminals may cause electric shock or fire.

7. Notes for Installation and Maintenance

Main Tools for Installation and Maintenance



Level meter



Measuring tape



Screw driver



Impact drill



Drill head



Electric drill



Electroprobe



Universal meter



Torque wrench



Open-end wrench



Inner hexagon spanner



Electronic leakage detector



Vacuum pump



Pressure meter



Pipe pliers



Pipe pliers



Pipe cutter



Pipe expander



Pipe bender



Soldering appliance



Refrigerant container



Electronic scale

8. Installation

8.1 Installation Dimension Diagram

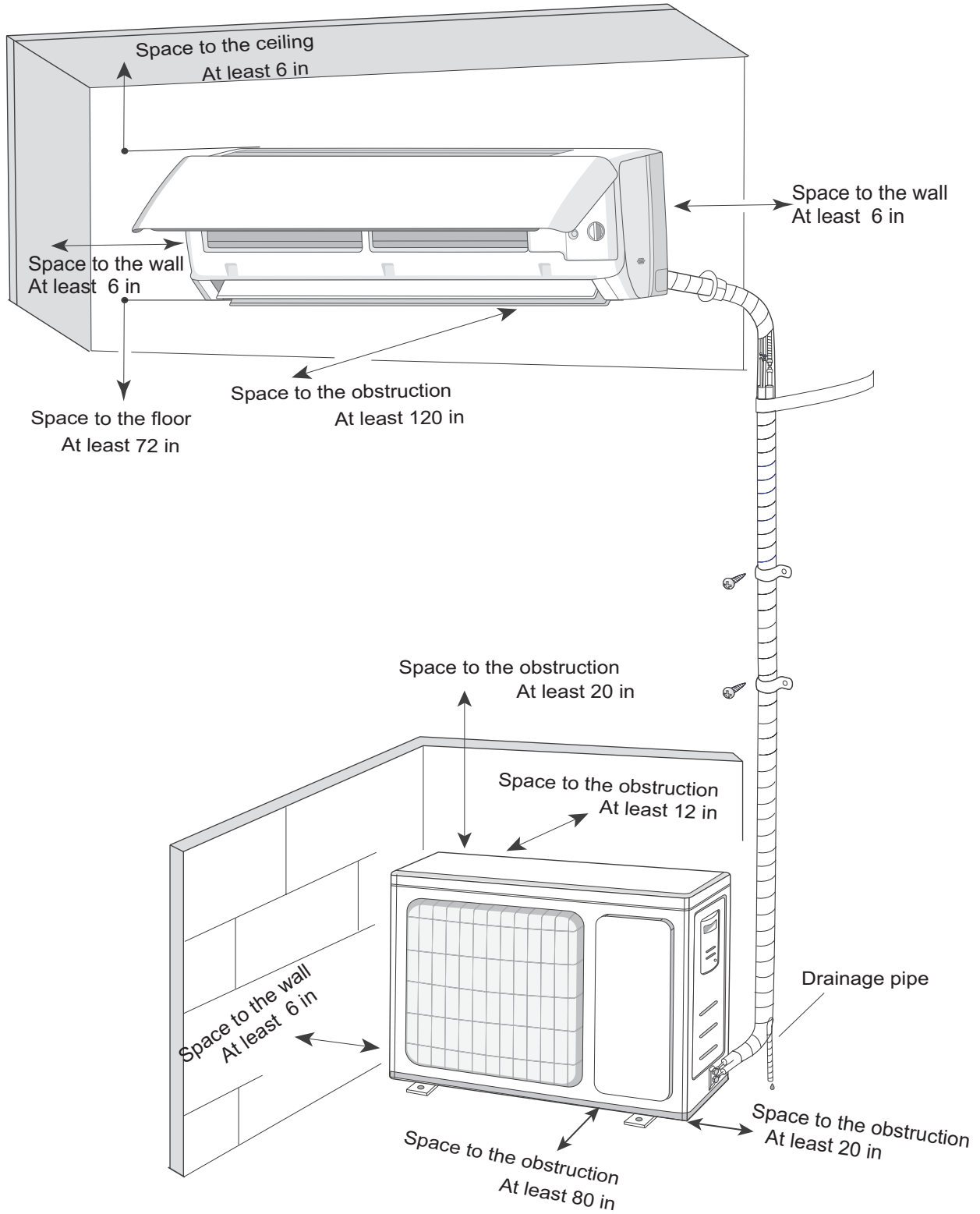

8. Installation

Installation Procedures

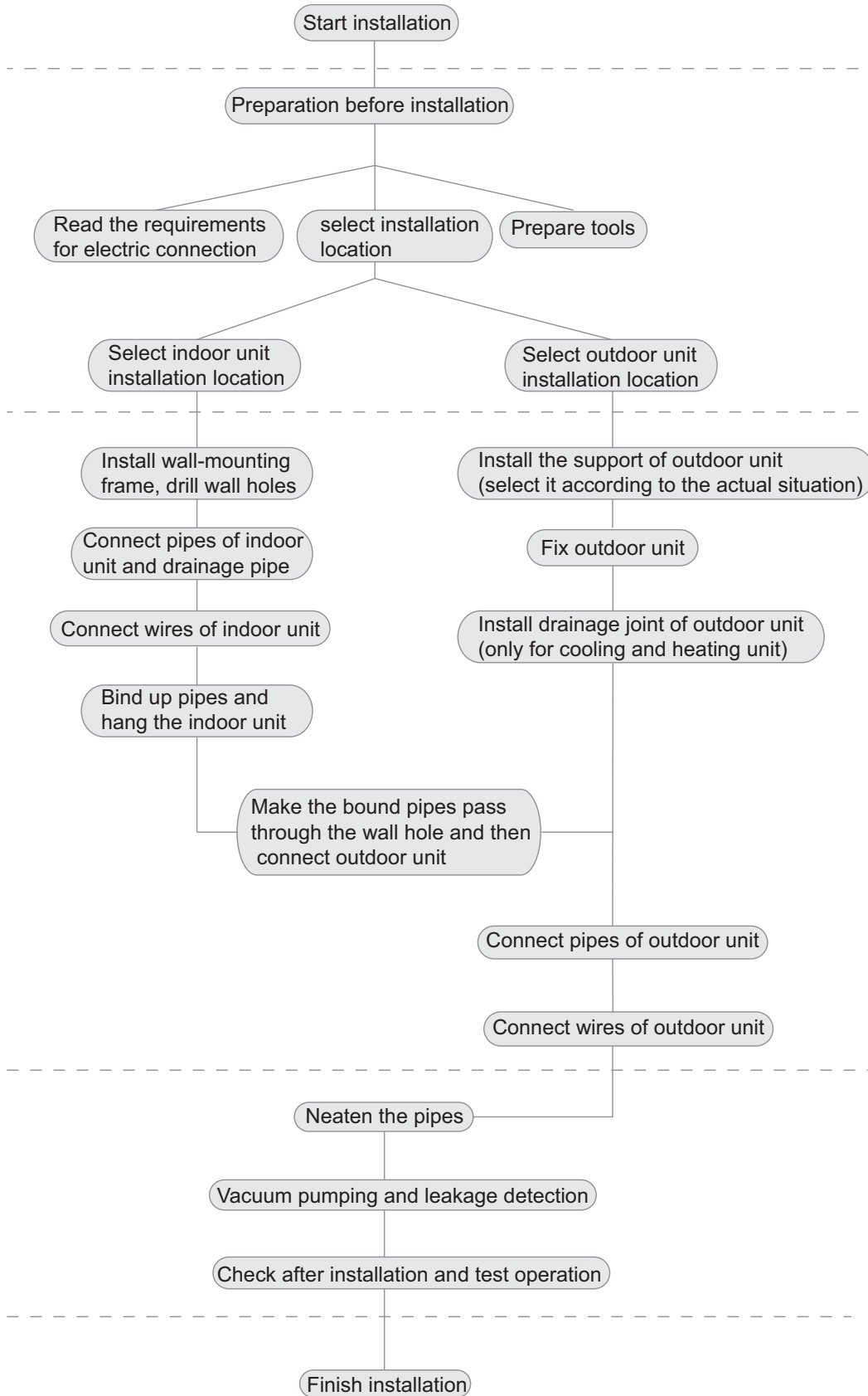

Note: this flow is only for reference; please find the more detailed installation steps in this se

8. Installation

8.2 Installation Parts-checking

No.	Name
1	Indoor unit
2	Outdoor unit
3	Connection pipe
4	Drainage pipe
5	Wall-mounting frame
6	Connecting cable(power cord)
7	Wall pipe
8	Sealing gum
9	Wrapping tape
10	Support of outdoor unit
11	Fixing screw
12	Drainage plug(cooling and heating unit)
13	Owners manual, remote controller

⚠ Note:

1. Please contact the local agent for installation.
2. Don't use unqualified power cord.

8.3 Selection of Installation Location

1. Basic Requirement:

Installing the unit in the following places may cause malfunction. If it is unavoidable, please consult the local dealer:

- (1) The place with strong heat sources, vapors, flammable or explosive gas, or volatile objects spread in the air.
- (2) The place with high-frequency devices (such as welding machine, medical equipment).
- (3) The place near coast area.
- (4) The place with oil or fumes in the air.
- (5) The place with sulfured gas.
- (6) Other places with special circumstances.
- (7) The appliance shall not be installed in the laundry.
- (8) It's not allowed to be installed on the unstable or motive base structure (such as truck) or in the corrosive environment (such as chemical factory).

2. Indoor Unit:

- (1) There should be no obstruction near air inlet and air outlet.
- (2) Select a location where the condensation water can be dispersed easily and won't affect other people.
- (3) Select a location which is convenient to connect the outdoor unit and near the power socket.
- (4) Select a location which is out of reach for children.
- (5) The location should be able to withstand the weight of indoor unit and won't increase noise and vibration.
- (6) The appliance must be installed 2.5m (6ft min) above floor.
- (7) Don't install the indoor unit right above the electric appliance.
- (8) Please try your best to keep way from fluorescent lamp.

3. Outdoor Unit:

- (1) Select a location where the noise and outflow air emitted by the outdoor unit will not affect neighborhood.
- (2) The location should be well ventilated and dry, in which the outdoor unit won't be exposed directly to sunlight or strong wind.
- (3) The location should be able to withstand the weight of outdoor

unit.

(4) Make sure that the installation follows the requirement of installation dimension diagram.

(5) Select a location which is out of reach for children and far away from animals or plants. If it is unavoidable, please add fence for safety purpose.

8.4 Electric Connection Requirement

1. Safety Precaution

(1) Must follow the electric safety regulations when installing the unit.

(2) According to the local safety regulations, use qualified power supply circuit and air switch.

(3) Make sure the power supply matches with the requirement of air conditioner. Unstable power supply or incorrect wiring may result in electric shock, fire hazard or malfunction. Please install proper power supply cables before using the air conditioner.

(4) Properly connect the live wire, neutral wire and grounding wire of power socket.

(5) Be sure to cut off the power supply before proceeding any work related to electricity and safety.

(6) Do not put through the power before finishing installation.

(7) The temperature of refrigerant circuit will be high, please keep the interconnection cable away from the copper tube.

(8) The appliance shall be installed in accordance with national wiring regulations.

2. Grounding Requirement:

(1) The air conditioner is I class electric appliance. It must be properly grounding with specialized grounding device by a professional. Please make sure it is always grounded effectively, otherwise it may cause electric shock.

(2) The yellow-green wire in air conditioner is grounding wire, which can't be used for other purposes.

(3) The grounding resistance should comply with national electric safety regulations.

(4) The appliance must be positioned so that the plug is accessible.

(5) An all-pole disconnection switch having a contact separation of at least 3mm in all poles should be connected in fixed wiring.

(6) Including an air switch with suitable capacity, please note the following table. Air switch should be included magnet buckle and heating buckle function, it can protect the circuit-short and overload. (Caution: please do not use the fuse only for protect the circuit)

8.5 Installation of Indoor Unit

1. Choosing Installation location

Recommend the installation location to the client and then confirm it with the client.

2. Install Wall-mounting Frame

(1) Hang the wall-mounting frame on the wall; adjust it in horizontal position with the level meter and then point out the screw fixing holes on the wall.

(2) Drill the screw fixing holes on the wall with impact drill (the specification of drill head should be the same as the plastic expansion particle) and then fill the plastic expansion particles in

8. Installation

the holes.

(3) Fix the wall-mounting frame on the wall with tapping screws and then check if the frame is firmly installed by pulling the frame. If the plastic expansion particle is loose, please drill another fixing hole nearby.

3. Install Wall-mounting Frame

(1) Choose the position of piping hole according to the direction of outlet pipe. The position of piping hole should be a little lower than the wall-mounted frame. (As show in Fig.1)

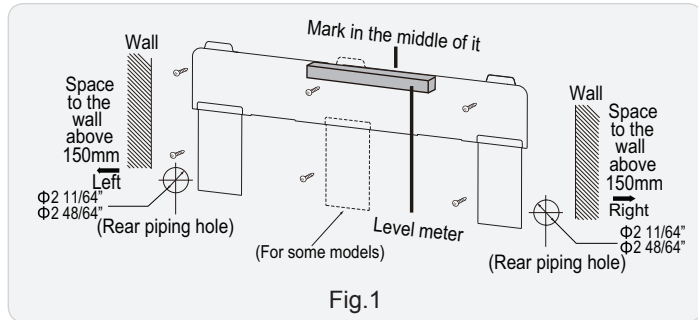

(2) Open a piping hole with the diameter of $\Phi 55/70\text{mm}$ on the selected outlet pipe position. In order to drain smoothly, slant the piping hole on the wall slightly downward to the outdoor side with the gradient of $5\text{-}10^\circ$. (As show in Fig.2)

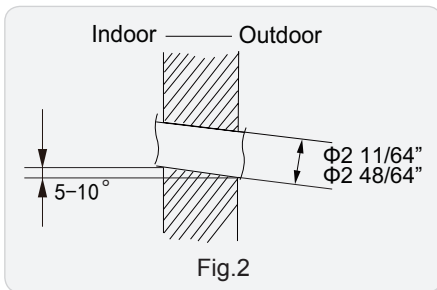

⚠ Note:

Pay attention to dust prevention and take relevant safety measures when opening the hole.

4. Outlet Pipe

(1) The pipe can be led out in the direction of right, rear right, left or rear left. (As show in Fig.3)

(2) When selecting leading out the pipe from left or right, please cut off the corresponding hole on the bottom case. (As show in Fig.4)

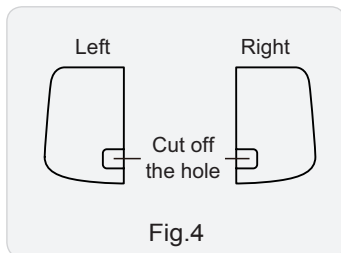
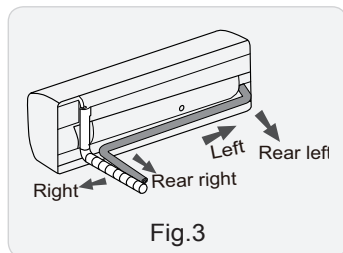

5. Connect the Pipe of Indoor Unit

(1) Aim the pipe joint at the corresponding bellmouth. (As show in Fig.5)

(2) Pretightening the union nut with hand.

(3) Adjust the torque force by referring to the following sheet. Place the open-end wrench on the pipe joint and place the

torque wrench on the union nut. Tighten the union nut with torque wrench. (As show in Fig.6)

(4) Wrap the indoor pipe and joint of connection pipe with insulating pipe, and then wrap it with tape. (As show in Fig.7)

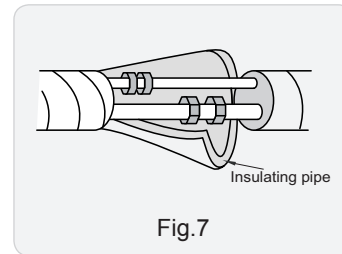
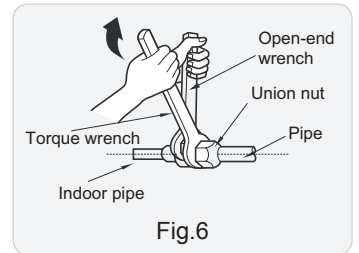
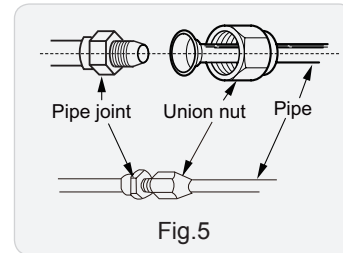

Refer to the following table for wrench moment of force:

Piping size (inch)	Tightening torque (N·m)
1/4	15~20
3/8	30~40
1/2	45~55
5/8	60~65
3/4	70~75

6. Install Drain Hose

(1) Connect the drain hose to the outlet pipe of indoor unit. (As show in Fig.8)

(2) Bind the joint with tape. (As show in Fig.9)

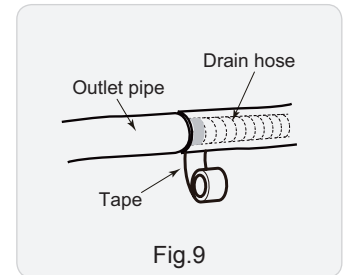
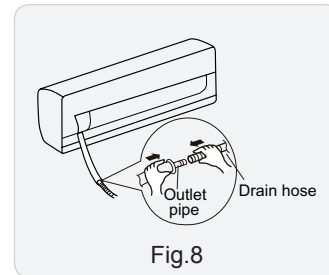

⚠ Note:

(1) Add insulating pipe in the indoor drain hose in order to prevent condensation.

(2) The plastic expansion particles are not provided. (As show in Fig.10)

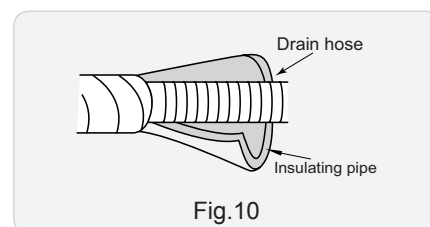

8. Installation

7. Connect Wire of Indoor Unit

(1) Open the panel, remove the screw on the wiring cover and then take down the cover. (As show in Fig.11)

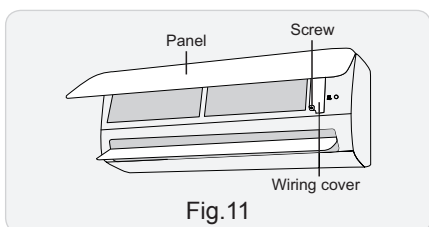

Fig.11

(2) Make the power connection wire go through the cable-cross hole at the back of indoor unit and then pull it out from the front side. (As show in Fig.12)

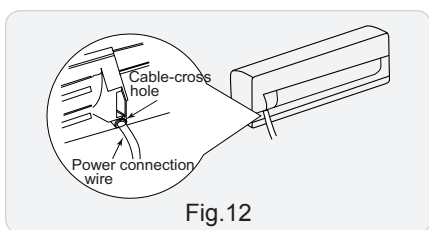

Fig.12

(3) Remove the wire clip; connect the power connection wiresignal control wire (only for cooling and heating unit) to the wiring terminal according to the color; tighten the screw and then fix the power connection wire with wire clip. (As show in Fig.13)

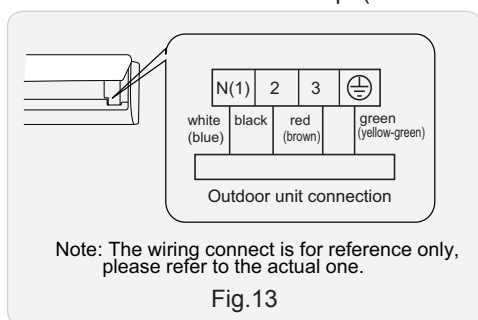

Fig.13

(4) Put wiring cover back and then tighten the screw.
(5) Close the panel.

⚠ Note:

- (1) All wires of indoor unit and outdoor unit should be connected by a professional.
- (2) If the length of power connection wire is insufficient, please contact the supplier for a new one. Avoid extending the wire by yourself.
- (3) For the air conditioner with plug, the plug should be reachable after finishing installation.
- (4) For the air conditioner without plug, an air switch must be installed in the line. The air switch should be all-pole parting and the contact parting distance should be more than 3mm.

8. Bind up Pipe

- (1) Bind up the connection pipe, power cord and drain hose with the band. (As show in Fig.14)
- (2) Reserve a certain length of drain hose and power cord for installation when binding them. When binding to a certain degree, separate the indoor power and then separate the drain hose. (As show in Fig.15)
- (3) Bind them evenly.
- (4) The liquid pipe and gas pipe should be bound separately at the end.

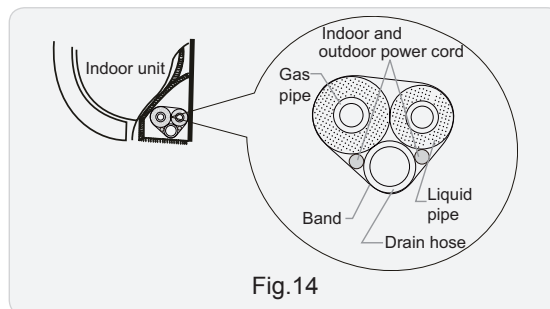

Fig.14

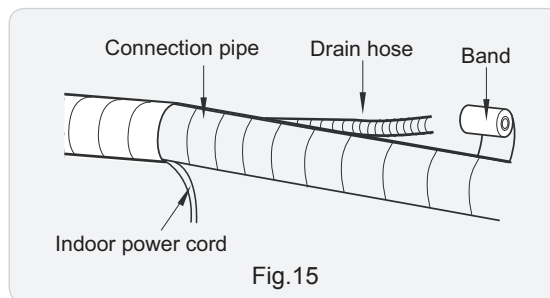

Fig.15

⚠ Note:

- (1) The power cord and control wire can't be crossed or winding.
- (2) The drain hose should be bound at the bottom.

9. Hang the Indoor Unit

- (1) Put the bound pipes in the wall pipe and then make them pass through the wall hole.
- (2) Hang the indoor unit on the wall-mounting frame.
- (3) Stuff the gap between pipes and wall hole with sealing gum.
- (4) Fix the wall pipe. (As show in Fig.16)
- (5) Check if the indoor unit is installed firmly and closed to the wall. (As show in Fig.17)

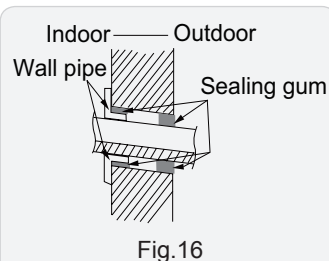

Fig.16

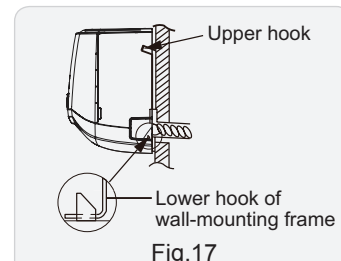

Fig.17

⚠ Note:

- Do not bend the drain hose too excessively in order to prevent blocking.

8.6 Installation of Outdoor unit

1. Fix the Support of Outdoor Unit(Select it according to the actual installation situation)

- (1) Select installation location according to the house structure.
- (2) Fix the support of outdoor unit on the selected location with expansion screws.

⚠ Note:

- (1) Take sufficient protective measures when installing the outdoor unit.
- (2) Make sure the support can withstand at least four times the unit weight.
- (3) The outdoor unit should be installed at least 3cm above the floor in order to install drain joint.(As show in Fig.18)

8. Installation

(4) For the unit with cooling capacity of 2300W~5000W, 6 expansion screws are needed; for the unit with cooling capacity of 6000W~8000W, 8 expansion screws are needed; for the unit with cooling capacity of 10000W~16000W, 10 expansion screws are needed.

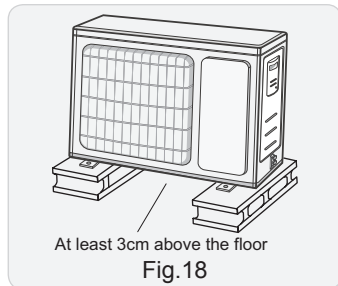

Fig.18

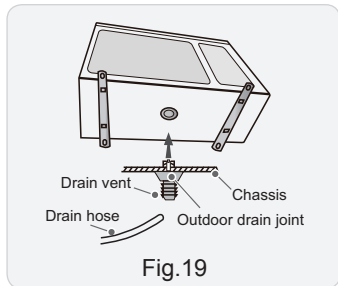

Fig.19

2. Install Drain Joint(Only for cooling and heating unit)

- (1) Connect the outdoor drain joint into the hole on the chassis.
- (2) Connect the drain hose into the drain vent.(As show in Fig.19)

3. Fix Outdoor Unit

- (1) Place the outdoor unit on the support.
- (2) Fix the foot holes of outdoor unit with bolts.(As show in Fig.20)

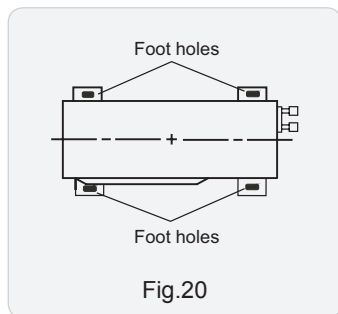

Fig.20

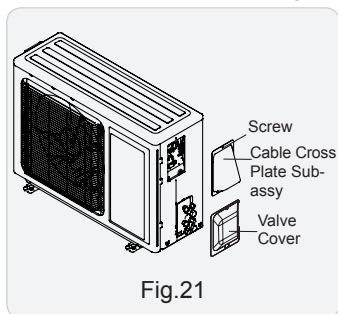

Fig.21

4. Connect Indoor and Outdoor Pipes

- (1) Remove the screw on the right handle of outdoor unit and then remove the handle. (As show in Fig.21)
- (2) Remove the screw cap of valve and aim the pipe joint at the bellmouth of pipe. (As show in Fig.22)

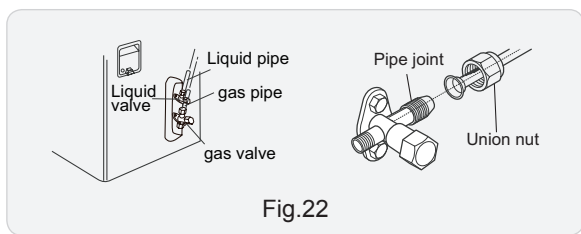

Fig.22

- (3) Pretightening the union nut with hand.
- (4) Tighten the union nut with torque wrench .

Refer to the following table for wrench moment of force :

Piping size (inch)	Tightening torque (N·m)
1/4	15~20
3/8	30~40
1/2	45~55
5/8	60~65
3/4	70~75

5. Connect Outdoor Electric Wire

- (1) Remove the wire clip; connect the power connection wire and signal control wire (only for cooling and heating unit) to the wiring terminal according to the color; fix them with screws. (As show in Fig.23)

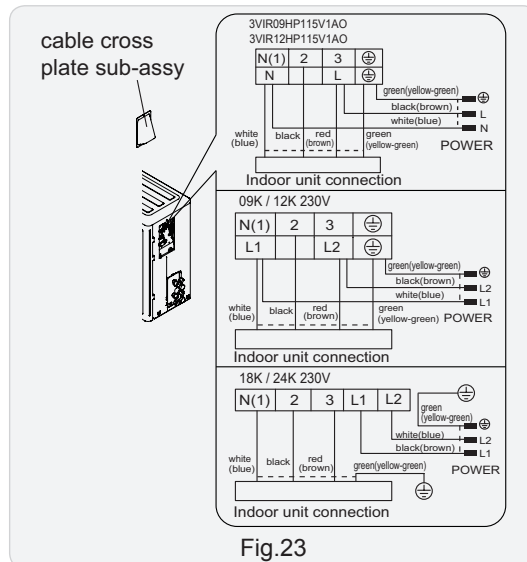

Fig.23

Note: the wiring connect is for reference only, please refer to the actual one.

⚠ Note:

- (1) After tightening the screw, pull the power cord slightly to check if it is firm.
- (2) Never cut the power connection wire to prolong or shorten the distance.
- (3) The connecting wire and connection pipe cannot touch each other.
- (4) Top cover of outdoor unit and electric box assembly should be fixed by the screw. Otherwise, it can cause a fire, or short circuit caused by water or dust.

Install the over line pipe

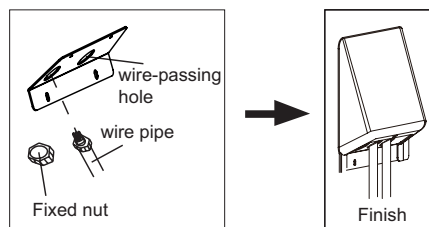

6. Neaten the Pipes

- (1) The pipes should be placed along the wall, bent reasonably and hidden possibly. Min. semidiameter of bending the pipe is 10cm.
- (2) If the outdoor unit is higher than the wall hole, you must set a U-shaped curve in the pipe before pipe goes into the room, in order to prevent rain from getting into the room. (As show in Fig.24)

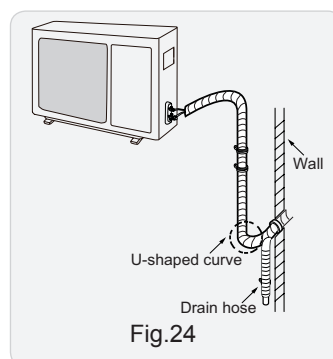

Fig.24

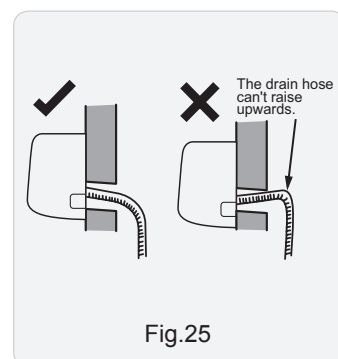
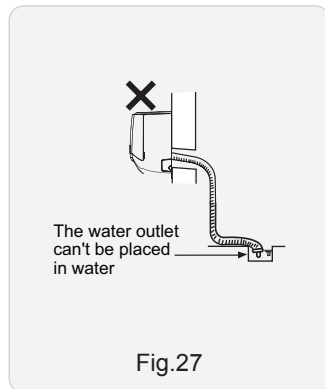
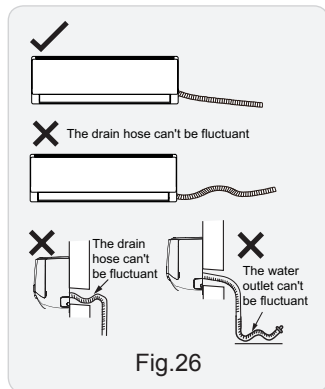

Fig.25

8. Installation

⚠ Note:

- (1) The through-wall height of drain hose shouldn't be higher than the outlet pipe hole of indoor unit.(As show in Fig.25)
- (2) Slant the drain hose slightly downwards. The drain hose can't be curved, raised and fluctuant, etc.(As show in Fig.26)
- (3) The water outlet can't be placed in water in order to drain smoothly.(As show in Fig.27)



8.7 Vacuum Pumping and Leak Detection

1. Use Vacuum Pump

- (1) Remove the valve caps on the liquid valve and gas valve and the nut of refrigerant charging vent.
- (2) Connect the charging hose of manifold to the refrigerant charging vent of gas valve and then connect the other charging hose to the vacuum pump.
- (3) Open the manifold completely and operate for 10-15min to check if the pressure of manifold remains in -14.5 Psi.
- (4) Close the vacuum pump and maintain this status for 1-2min to check if the pressure of manifold remains in -14.5 Psi. If the pressure decreases, there may be leakage.
- (5) Remove the manifold, open the valve core of liquid valve and gas valve completely with inner hexagon spanner.
- (6) Tighten the screw caps of valves and refrigerant charging vent.(As show in Fig.28)

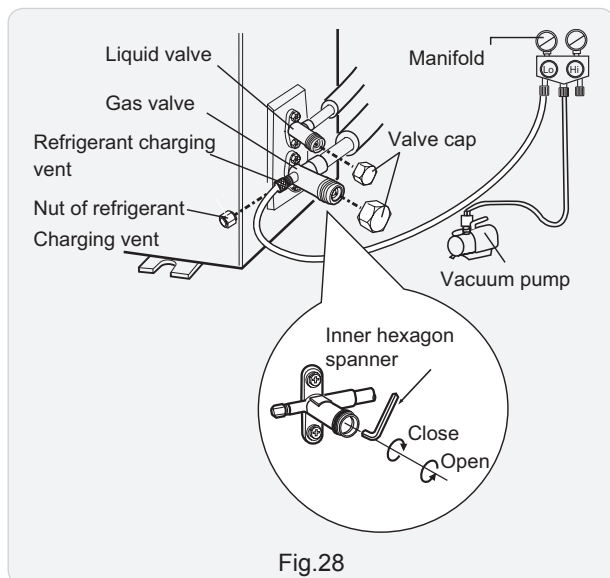

2. Leakage Detection

- (1) With leakage detector:
Check if there is leakage with leakage detector.
- (2) With soap water:
If leakage detector is not available, please use soap water for leakage detection. Apply soap water at the suspected position and keep the soap water for more than 3min. If there are air bubbles coming out of this position, There's a leakage.

8.8 Check after Installation and Test operation

1. Check after Installation

Check according to the following requirement after finishing installation.

NO.	Items to be checked	Possible malfunction
1	Has the unit been installed firmly?	The unit may drop, shake or emit noise.
2	Have you done the refrigerant leakage test?	It may cause insufficient cooling (heating) capacity.
3	Is heat insulation of pipeline sufficient?	It may cause condensation and water dripping.
4	Is water drained well?	It may cause condensation and water dripping.
5	Is the voltage of power supply according to the voltage marked on the nameplate?	It may cause malfunction or damage the parts.
6	Is electric wiring and pipeline installed correctly?	It may cause malfunction or damage the parts.
7	Is the unit grounded securely?	It may cause electric leakage.
8	Does the power cord follow the specification?	It may cause malfunction or damage the parts.
9	Is there any obstruction in air inlet and air outlet?	It may cause insufficient cooling (heating) capacity.
10	The dust and sundries caused during installation are removed?	It may cause malfunction or damaging the parts.
11	The gas valve and liquid valve of connection pipe are open completely?	It may cause insufficient cooling (heating) capacity.
12	Is the inlet and outlet of piping hole been covered?	It may cause insufficient cooling(heating) capacity or waster eletricity.

2. Test Operation

- (1) Preparation of test operation
 - The client approves the air conditioner installation.
 - Specify the important notes for air conditioner to the client.
- (2) Method of test operation
 - Put through the power, press ON/OFF button on the remote controller to start operation.
 - Press MODE button to select AUTO, COOL, DRY, FAN and HEAT to check whether the operation is normal or not.
 - If the ambient temperature is lower than 16°C , the air conditioner can't start cooling.

9. Maintenance

9.1 Error Code List

No.	Malfunction Name	Display Method of Indoor Unit	A/C status	Possible Causes
		Dual-8 Code Display		
1	High pressure protection of system	E1	During cooling and drying operation, except indoor fan operates, all loads stop operation. During heating operation, the complete unit stops.	Possible reasons: 1. Refrigerant was superabundant; 2. Poor heat exchange (including filth blockage of heat exchanger and bad radiating environment); Ambient temperature is too high.
2	Low pressure protection of system	E3	The Dual-8 Code Display will show E3 until the low pressure switch stop operation.	1.Low-pressure protection 2.Low-pressure protection of system 3.Low-pressure protection of compressor
3	High discharge temperature protection of compressor	E4	During cooling and drying operation, compressor and outdoor fan stop while indoor fan operates. During heating operation, all loads stop.	Please refer to the malfunction analysis (discharge protection, overload).
4	Overcurrent protection	E5	During cooling and drying operation, compressor and outdoor fan stop while indoor fan operates. During heating operation, all loads stop.	1. Supply voltage is unstable; 2. Supply voltage is too low and load is too high; 3. Evaporator is dirty.
5	Communication Malfunction	E6	During cooling operation, compressor stops while indoor fan motor operates. During heating operation, the complete unit stops.	Refer to the corresponding malfunction analysis.
6	High temperature resistant protection	E8	During cooling operation: compressor will stop while indoor fan will operate. During heating operation, the complete unit stops.	Refer to the malfunction analysis (overload, high temperature resistant).
7	EEPROM malfunction	EE	During cooling and drying operation, compressor will stop while indoor fan will operate; During heating operation, the complete unit will stop	Replace outdoor control panel AP1
8	Limit/decrease frequency due to high temperature of module	EU	All loads operate normally, while operation frequency for compressor is decreased	Discharging after the complete unit is de-energized for 20mins, check whether the thermal grease on IPM Module of outdoor control panel AP1 is sufficient and whether the radiator is inserted tightly. If it's no use, please replace control panel AP1.
9	Malfunction protection of jumper cap	C5	Wireless remote receiver and button are effective, but can not dispose the related command	1. No jumper cap insert on mainboard. 2. Incorrect insert of jumper cap. 3. Jumper cap damaged. 4. Abnormal detecting circuit of mainboard.
10	Gathering refrigerant	Fo	When the outdoor unit receive signal of Gathering refrigerant ,the system will be forced to run under cooling mode for gathering refrigerant	Nominal cooling mode

9. Maintenance

No.	Malfunction Name	Display Method of Indoor Unit	A/C status	Possible Causes
		Dual-8 Code Display		
11	Indoor ambient temperature sensor is open/short circuited	F1	During cooling and drying operation, indoor unit operates while other loads will stop; during heating operation, the complete unit will stop operation.	<ol style="list-style-type: none"> 1. Loosening or bad contact of indoor ambient temp. sensor and mainboard terminal. 2. Components in mainboard fell down leads short circuit. 3. Indoor ambient temp. sensor damaged.(check with sensor resistance value chart) 4. Mainboard damaged.
12	Indoor evaporator temperature sensor is open/short circuited	F2	AC stops operation once reaches the setting temperature. Cooling, drying: internal fan motor stops operation while other loads stop operation; heating: AC stop operation	<ol style="list-style-type: none"> 1. Loosening or bad contact of Indoor evaporator temp. sensor and mainboard terminal. 2. Components on the mainboard fall down leads short circuit. 3. Indoor evaporator temp. sensor damaged. (check temp. sensor value chart for testing) 4. Mainboard damaged.
13	Outdoor ambient temperature sensor is open/short circuited	F3	During cooling and drying operating, compressor stops while indoor fan operates; During heating operation, the complete unit will stop operation	Outdoor temperature sensor hasn't been connected well or is damaged. Please check it by referring to the resistance table for temperature sensor)
14	Outdoor condenser temperature sensor is open/short circuited	F4	During cooling and drying operation, compressor stops while indoor fan will operate; During heating operation, the complete unit will stop operation.	Outdoor temperature sensor hasn't been connected well or is damaged. Please check it by referring to the resistance table for temperature sensor)
16	Outdoor discharge temperature sensor is open/short circuited	F5	During cooling and drying operation, compressor will stop after operating for about 3 mins, while indoor fan will operate; During heating operation, the complete unit will stop after operating for about 3 mins.	<ol style="list-style-type: none"> 1.Outdoor temperature sensor hasn't been connected well or is damaged. Please check it by referring to the resistance table for temperature sensor) 2.The head of temperature sensor hasn't been inserted into the copper tube
17	Limit/decrease frequency due to overload	F6	All loads operate normally, while operation frequency for compressor is decreased	Refer to the malfunction analysis (overload, high temperature resistant)
18	Decrease frequency due to overcurrent	F8	All loads operate normally, while operation frequency for compressor is decreased	The input supply voltage is too low; System pressure is too high and overload
19	Decrease frequency due to high air discharge	F9	All loads operate normally, while operation frequency for compressor is decreased	Overload or temperature is too high; Refrigerant is insufficient; Malfunction of electric expansion valve (EKV)
20	Limit/decrease frequency due to antifreezing	FH	All loads operate normally, while operation frequency for compressor is decreased	Poor air-return in indoor unit or fan speed is too low

9. Maintenance

No.	Malfunction Name	Display Method of Indoor Unit	A/C status	Possible Causes
		Dual-8 Code Display		
21	Voltage for DC bus-bar is too high	PH	During cooling and drying operation, compressor will stop while indoor fan will operate; During heating operation, the complete unit will stop operation.	1. Measure the voltage of position L and N on wiring board (XT), if the voltage is higher than 265VAC, turn on the unit after the supply voltage is increased to the normal range. 2.If the AC input is normal, measure the voltage of electrolytic capacitor C on control panel (AP1), if it's normal, There's malfunction for the circuit, please replace the control panel (AP1)
22	Voltage of DC bus-bar is too low	PL	During cooling and drying operation, compressor will stop while indoor fan will operate; During heating operation, the complete unit will stop	1. Measure the voltage of position L and N on wiring board (XT), if the voltage is higher than 150VAC, turn on the unit after the supply voltage is increased to the normal range. 2.If the AC input is normal, measure the voltage of electrolytic capacitor C on control panel (AP1), if it's normal, There's malfunction for the circuit, please replace the control panel (AP1)
23	Compressor Min frequency in test state	P0		Showing during min. cooling or min. heating test
24	Compressor rated frequency in test state	P1		Showing during nominal cooling or nominal heating test
25	Compressor maximum frequency in test state	P2		Showing during max. cooling or max. heating test
26	Compressor intermediate frequency in test state	P3		Showing during middle cooling or middle heating test
27	Overcurrent protection of phase current for compressor	P5	During cooling and drying operation, compressor will stop while indoor fan will operate; During heating operation, the complete unit will stop operation.	Refer to the malfunction analysis (IPM protection, loss of synchronism protection and overcurrent protection of phase current for compressor.

9. Maintenance

No.	Malfunction Name	Display Method of Indoor Unit	A/C status	Possible Causes
		Dual-8 Code Display		
28	Charging malfunction of capacitor	PU	During cooling and drying operation, compressor will stop while indoor fan will operate; During heating operation, the complete unit will stop	Refer to the part three—charging malfunction analysis of capacitor
29	Malfunction of module temperature sensor circuit	P7	During cooling and drying operation, compressor will stop while indoor fan will operate; During heating operation, the complete unit will stop	Replace outdoor control panel AP1
30	Module high temperature protection	P8	During cooling operation, compressor will stop while indoor fan will operate; During heating operation, the complete unit will stop	After the complete unit is de-energized for 20mins, check whether the thermal grease on IPM Module of outdoor control panel AP1 is sufficient and whether the radiator is inserted tightly. If it's no use, please replace control panel AP1.
31	Overload protection for compressor	H3	During cooling and drying operation, compressor will stop while indoor fan will operate; During heating operation, the complete unit will stop operation.	1. Wiring terminal OVC-COMP is loosened. In normal state, the resistance for this terminal should be less than 1ohm. 2. Refer to the malfunction analysis (discharge protection, overload)
32	IPM protection	H5	During cooling and drying operation, compressor will stop while indoor fan will operate; During heating operation, the complete unit will stop operation.	Refer to the malfunction analysis (IPM protection, loss of synchronism protection and overcurrent protection of phase current for compressor.
33	Module temperature is too high	P8	During cooling and drying operation, compressor and outdoor fan stop while indoor fan operates. During heating operation, all loads stop.	Radiating grease on IPM module of outdoor unit main board is not enough; screws have not been fixed tightly; Hardware malfunction of outdoor unit main board;
34	Internal motor (fan motor) do not operate	H6	Internal fan motor, external fan motor, compressor and electric heater stop operation, guide louver stops at present location.	1. Bad contact of DC motor feedback terminal. 2. Bad contact of DC motor control end. 3. Fan motor is stalling. 4. Motor malfunction. 5. Malfunction of mainboard revdetecting circuit.
35	Desynchro-nizing of compressor	H7	During cooling and drying operation, compressor will stop while indoor fan will operate; During heating operation, the complete unit will stop operation.	Refer to the malfunction analysis (IPM protection, loss of synchronism protection and overcurrent protection of phase current for compressor.
36	Outdoor DC fan motor malfunction	L3	Outdoor DC fan motor malfunction lead to compressor stop operation,	DC fan motor malfunction or system blocked or the connector loosed

9. Maintenance

No.	Malfunction Name	Display Method of Indoor Unit	A/C status	Possible Causes
		Dual-8 Code Display		
37	power protection	L9	compressor stop operation and Outdoor fan motor will stop 30s latter , 3 minutes latter fan motor and compressor will restart	To protect the electrical components when detect high power
38	Indoor unit and outdoor unit doesn't match	LP	compressor and Outdoor fan motor can't work	Indoor unit and outdoor unit doesn't match
39	Failure start-up	LC	During cooling and drying operation, compressor will stop while indoor fan will operate; During heating operation, the complete unit will stop operation.	Refer to the malfunction analysis
40	Cold air prevention protection	E9		Not the error code. It's the status code for the operation.
41	Anti-freezing rotection for evaporator	E2		Not the error code. It's the status code for the operation.
42	Malfunction of phase current detection circuit for compressor	U1	During cooling and drying operation, compressor will stop while indoor fan will operate; During heating operation, the complete unit will stop	Replace outdoor control panel AP1
43	Malfunction of voltage dropping for DC bus-bar	U3	During cooling and drying operation, compressor will stop while indoor fan will operate; During heating operation, the complete unit will stop	Supply voltage is unstable
44	Malfunction of complete unit's current detection	U5	During cooling and drying operation, the compressor will stop while indoor fan will operate; During heating operating, the complete unit will stop operation.	There's circuit malfunction on outdoor unit control panel AP1, please replace the outdoor unit control panel AP1.
45	The four-way valve is abnormal	U7	If this malfunction occurs during heating operation, the complete unit will stop operation.	1. Supply voltage is lower than AC175V; 2. Wiring terminal 4V is loosened or broken; 3. 4V is damaged, please replace 4V.
46	Malfunction of zero-cross detection circuit	U8	The complete unit stops	1. Power supply is abnormal; 2. Detection circuit of indoor control mainboard is abnormal.

9. Maintenance

No.	Malfunction Name	Display Method of Indoor Unit	A/C status	Possible Causes
		Dual-8 Code Display		
47	Malfunction of detecting plate(WIFI)	JF	Loads operate normally, while the unit can't be normally controlled by APP.	<ol style="list-style-type: none"> 1. Main board of indoor unit is damaged; 2. Detection board is damaged; 3. The connection between indoor unit and detection board is not good;
48	Refrigerant recovery mode	Fo		Refrigerant recovery. The Serviceman operates it for maintenance.
49	Undefined outdoor unit error	oE	Cool: compressor and outdoor fan stops operation, while indoor fan operates; Heat: compressor, outdoor fan and indoor fan stop operation.	<ol style="list-style-type: none"> 1. Outdoor ambient temperature exceeds the operation range of unit (eg: less than -20°C or more than 60°C for cooling; more than 30°C for heating); 2. Failure startup of compressor? 3. Are wires of compressor not connected tightly? 4. Is compressor damaged? 5. Is main board damaged?

9. Maintenance

Analysis or processing of some of the malfunction display:

1. Compressor discharge protection

Possible causes: shortage of refrigerant; blockage of air filter; poor ventilation or air flow short pass for condenser; the system has noncondensing gas (such as air, water etc.); blockage of capillary assy (including filter); leakage inside four-way valve causes incorrect operation; malfunction of compressor; malfunction of protection relay; malfunction of discharge sensor; outdoor temperature too high.

Processing method: refer to the malfunction analysis in the above section.

2. Low voltage overcurrent protection

Possible cause: Sudden drop of supply voltage.

3. Communication malfunction

Processing method: Check if communication signal cable is connected reliably.

4. Sensor open or short circuit

Processing method: Check whether sensor is normal, connected with the corresponding position on the controller and if damage of lead wire is found.

5. Compressor over load protection

Possible causes: insufficient or too much refrigerant; blockage of capillary and increase of suction temp.; improper running of compressor, burning in or stuck of bearing, damage of discharge valve; malfunction of protector.

Processing method: adjust refrigerant amount; replace the capillary; replace the compressor; use universal meter to check if the contactor of compressor is fine when it is not overheated, if not replace the protector.

6. System malfunction

ie overload protection. When tube temperature (Check the temperature of outdoor heat exchanger when cooling and check the temperature of indoor heat exchanger when heating) is too high, protection will be activated.

Possible causes: Outdoor temperature is too high when cooling; insufficient outdoor air circulation; refrigerant flow malfunction.

please refer to the malfunction analysis in the previous section for handling method .

7. IPM module protection

Processing method: Once the module malfunction happens, if it persists for a long time and can not be self-canceled, cut off the power and turn off the unit, and then re-energize the unit again after about 10 min. After repeating the procedure for several times, if the malfunction still exists, replace the module.

9. Maintenance

9.2 Procedure of Troubleshooting

1. Malfunction of Protection of Jumper Cap C5

Main detection points:

- Is there jumper cap on the mainboard?
- Is the jumper cap inserted correctly and tightly?
- The jumper is broken?
- The motor is broken?
- Detection circuit of the mainboard is defined abnormal?

Malfunction diagnosis process:

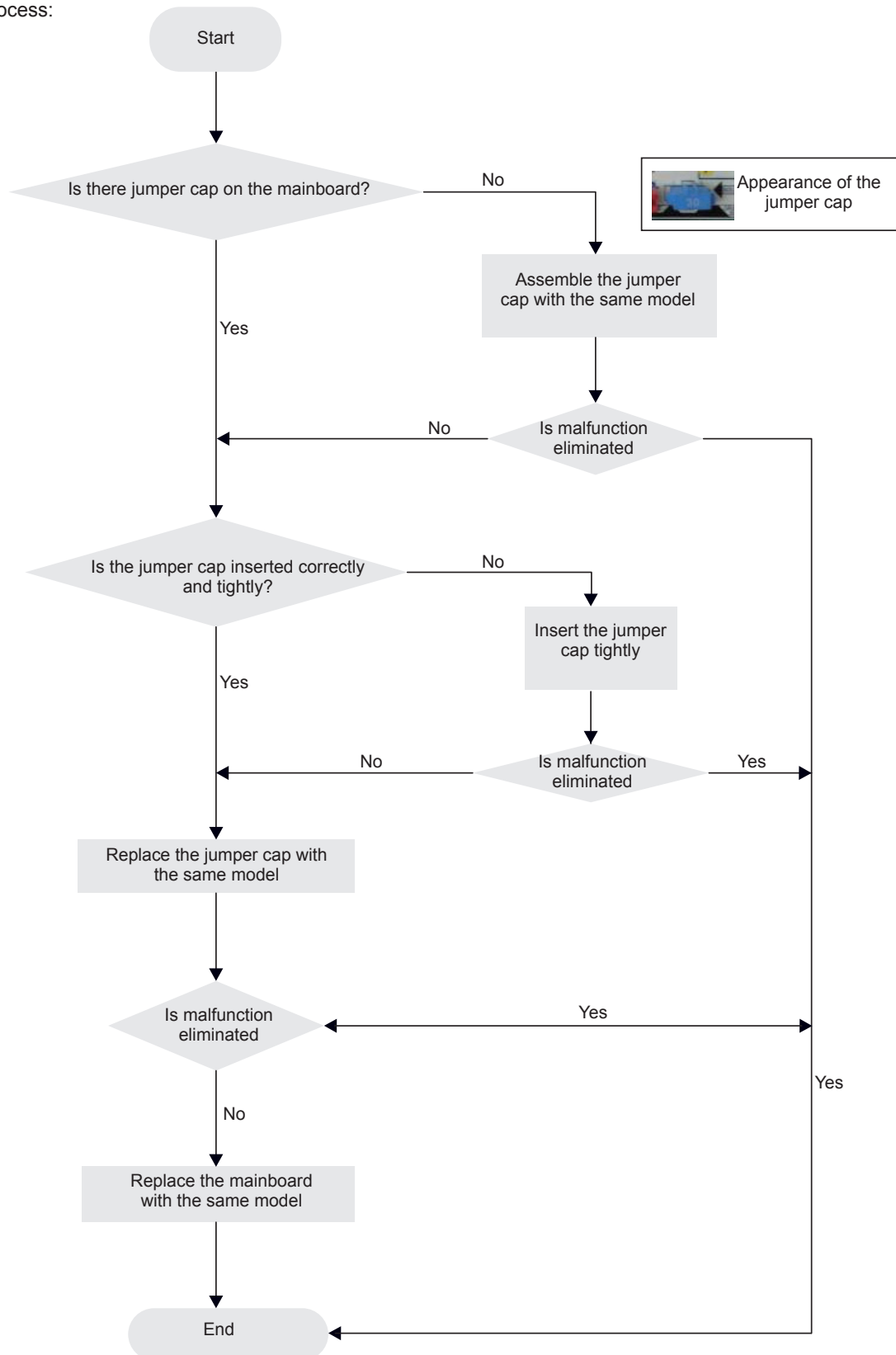

9. Maintenance

2. Communication malfunction E6

Main detection points:

- Check if the connection wire and the built-in wiring of indoor and outdoor unit are connected well and without damage;
- If the communication circuit of indoor mainboard is damaged? If the communication circuit of outdoor mainboard (AP1) is damaged?

Malfunction diagnosis process:

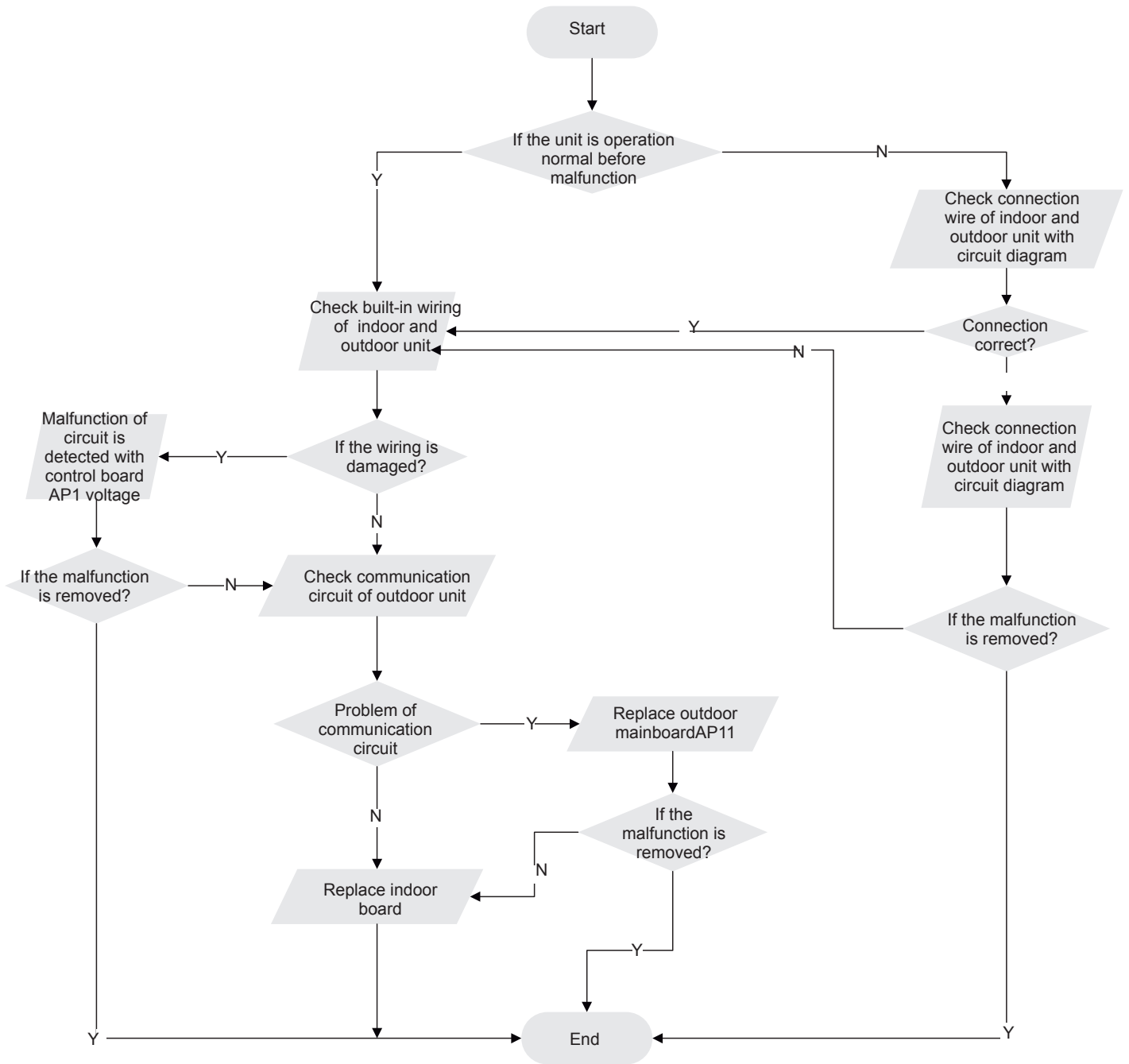

Note: method for checking the communication circuit of outdoor unit: cut off the communication wires of indoor/outdoor unit, and then measure the voltage between COM and N of the control board of outdoor unit (DC notch, about 56V)

9. Maintenance

3. IPM protection H5 , over-phase current of compressor P5

(AP1 hereinafter refers to the control board of the outdoor unit)

Main detection points:

(1) compressor COMP terminal (2) power supply voltage (3) compressor (4) charging amount of refrigerant (5) air inlet and air outlet of indoor/outdoor unit

Malfunction diagnosis process:

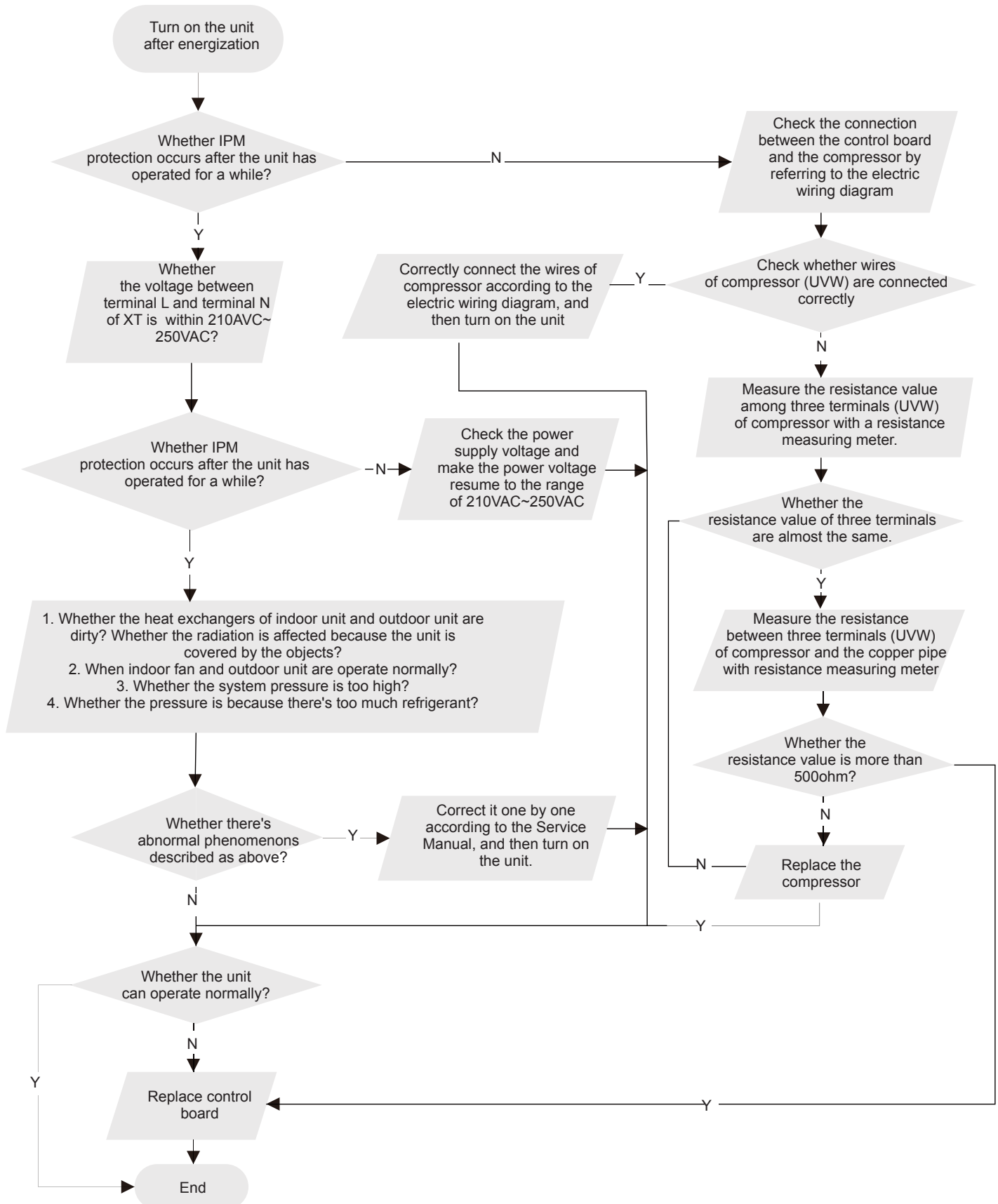

9. Maintenance

4. Overload protection of compressor H3, high discharge temperature protection of compressor E4 (AP1 hereinafter refers to the control board of the outdoor unit)

Main detection points:

(1) electronic expansion valve (2) expansion valve terminal (3) charging amount of refrigerant (4) overload protector

Malfunction diagnosis process:

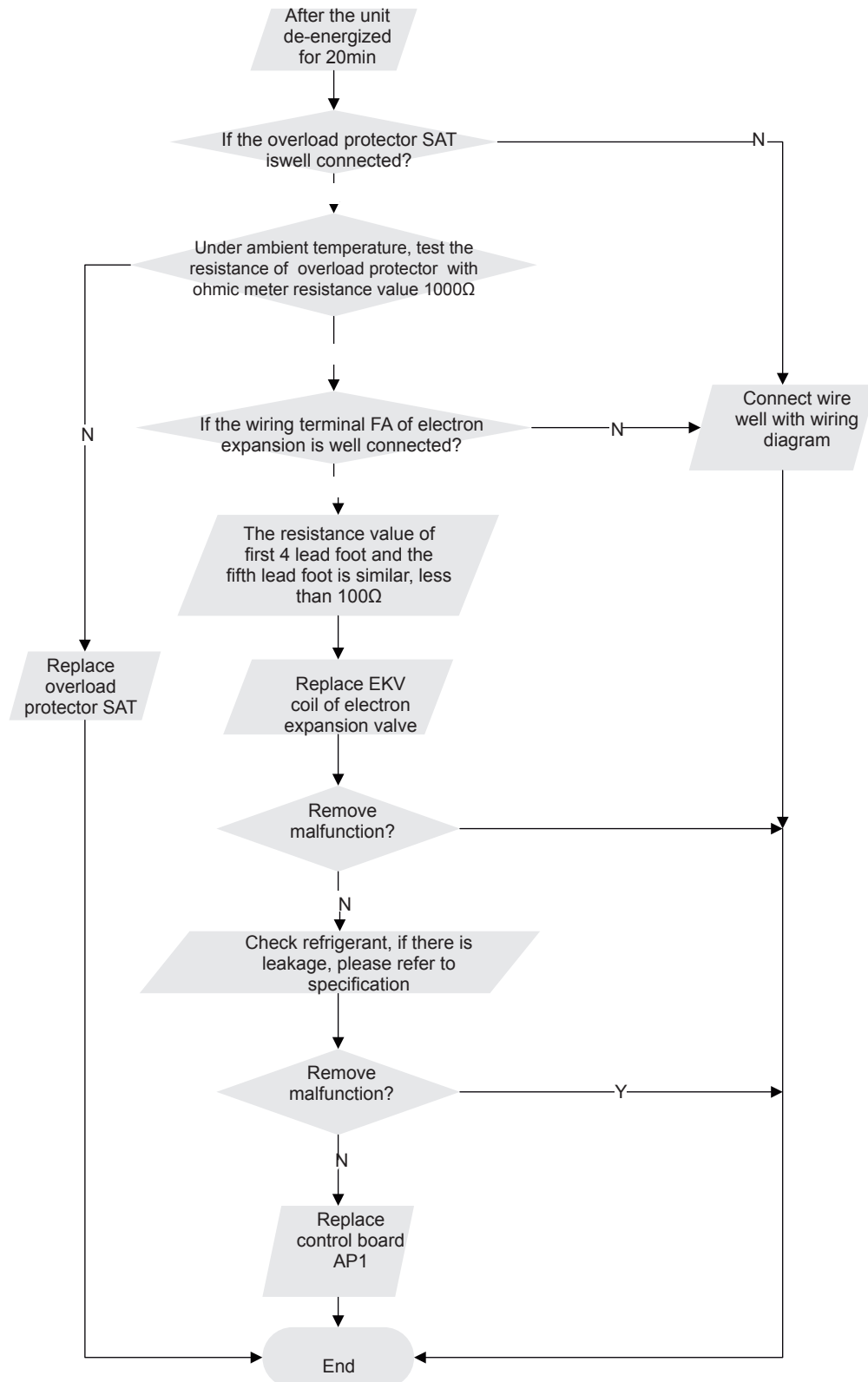

9. Maintenance

5. Malfunction of Temperature Sensor F1, F2

Main detection points:

(1) connection terminal (2) temperature sensor (3) main board

Malfunction diagnosis process:

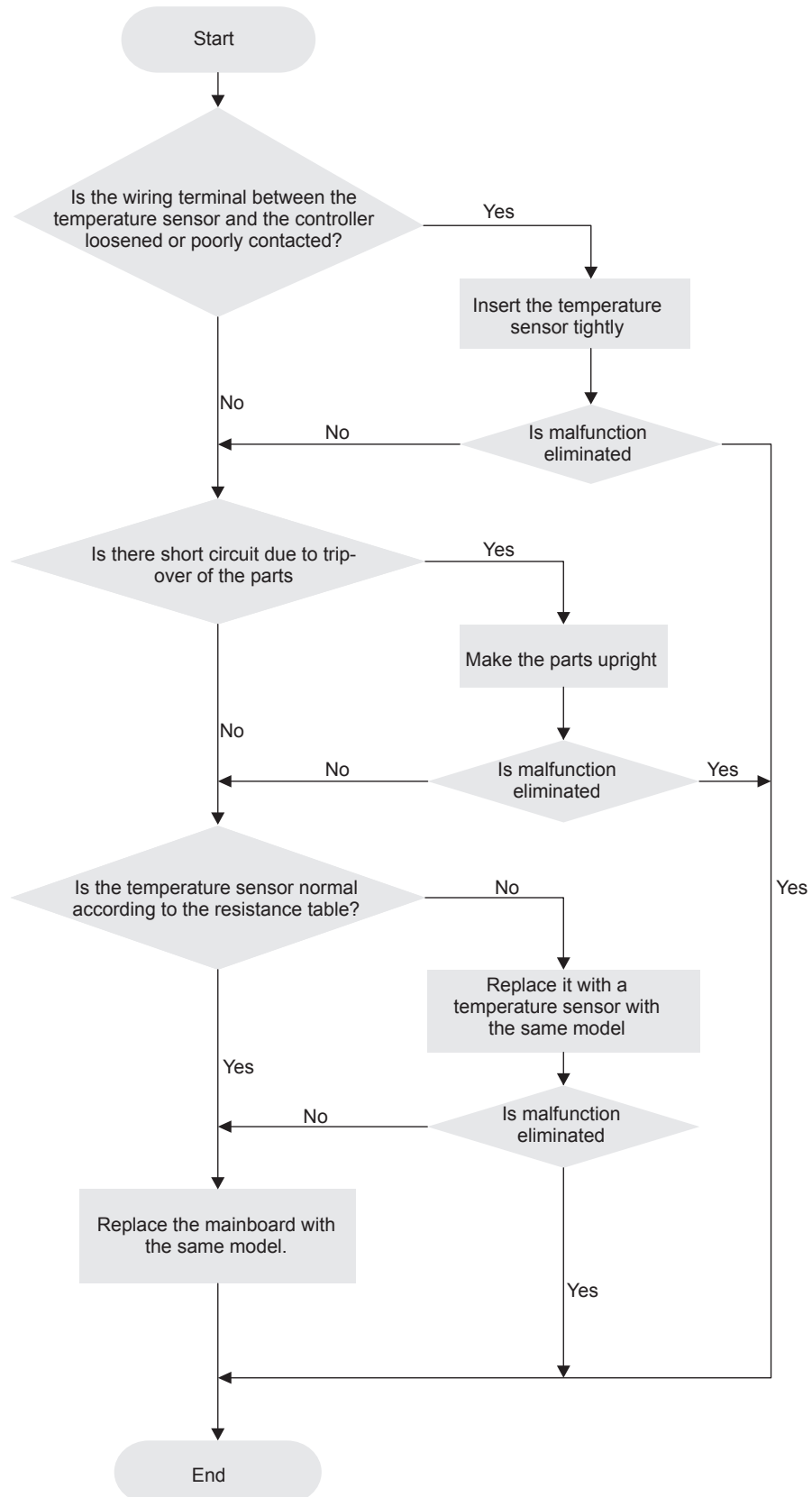

9. Maintenance

6. High temperature and overload protection (E8)(AP1 below means control board of outdoor unit)

Main detection points:

(1) outdoor temperature (2) fan (3)air inlet and air outlet of indoor/outdoor unit

Malfunction diagnosis process:

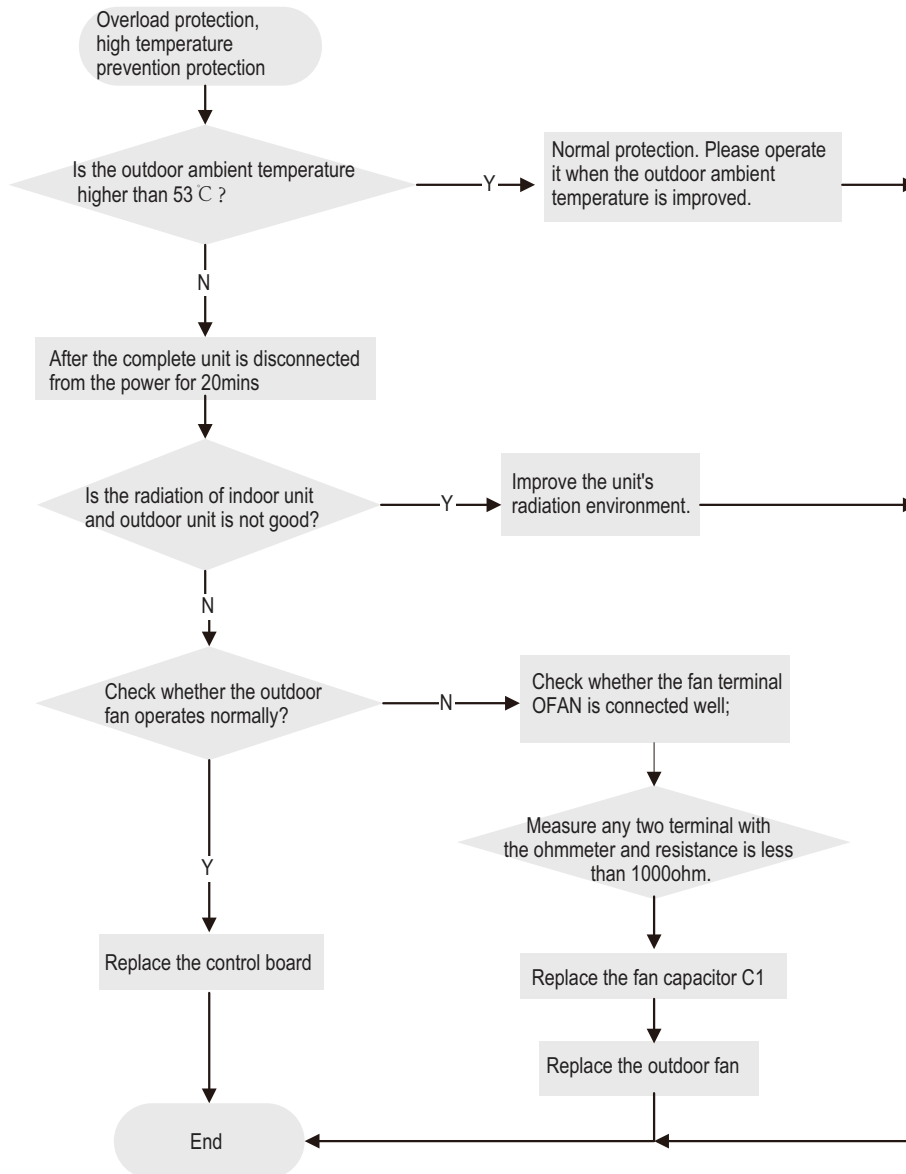

9. Maintenance

7. Malfunction of Zero-crossing Inspection Circuit Malfunction of the IDU Fan Motor U8

Main detection points:

- Instant energization after de-energization while the capacitor discharges slowly?
- The zero-cross detection circuit of the mainboard is defined abnormal?

Malfunction diagnosis process:

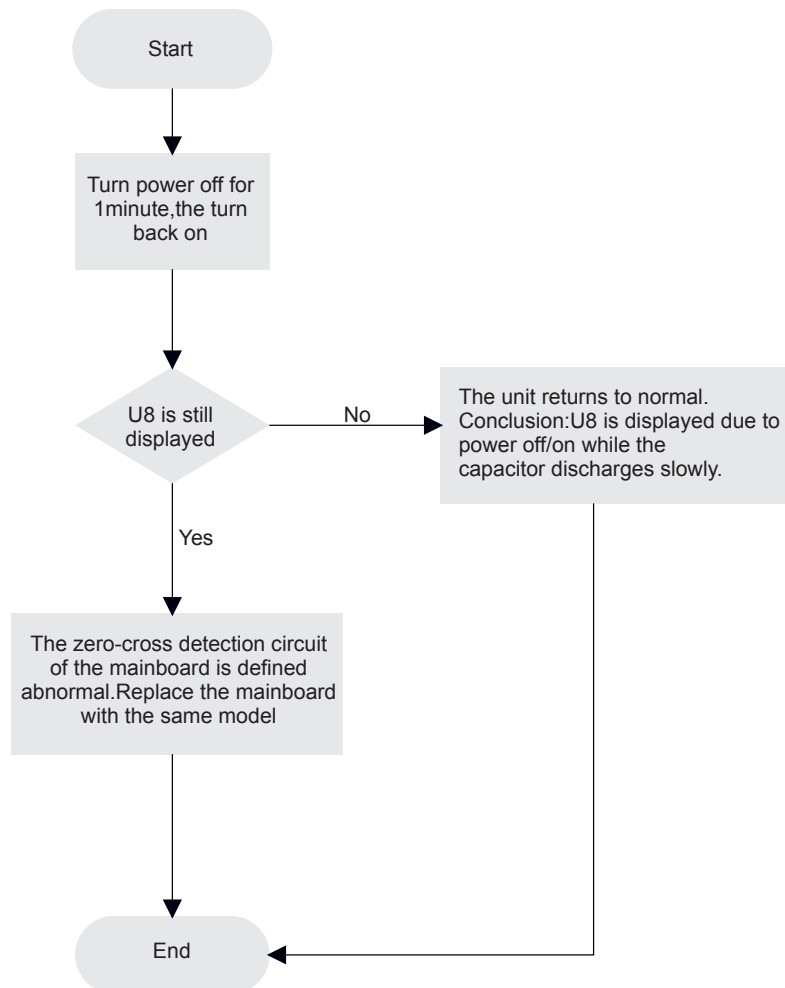

9. Maintenance

9. Desynchronization diagnosis for compressor H7

(AP1 hereinafter refers to the control board of the outdoor unit)

Main detection points:

(1) system pressure (2) power supply voltage

Malfunction diagnosis process:

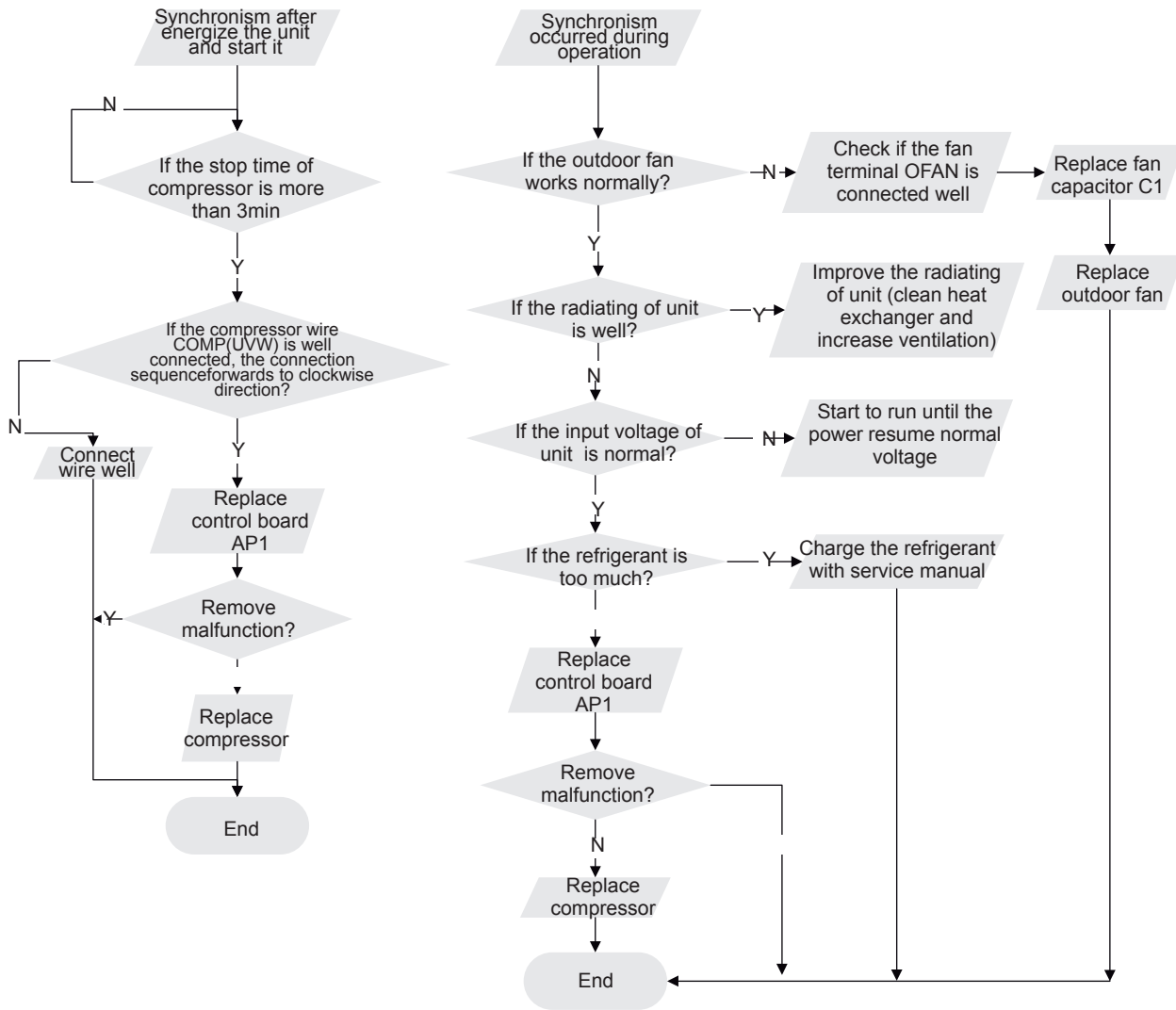

9. Maintenance

10. Malfunction of Overcurrent Protection E5

Main detection points:

- Is the supply voltage unstable with big fluctuation?
- Is the supply voltage too low with overload?
- Hardware trouble?

Malfunction diagnosis process:

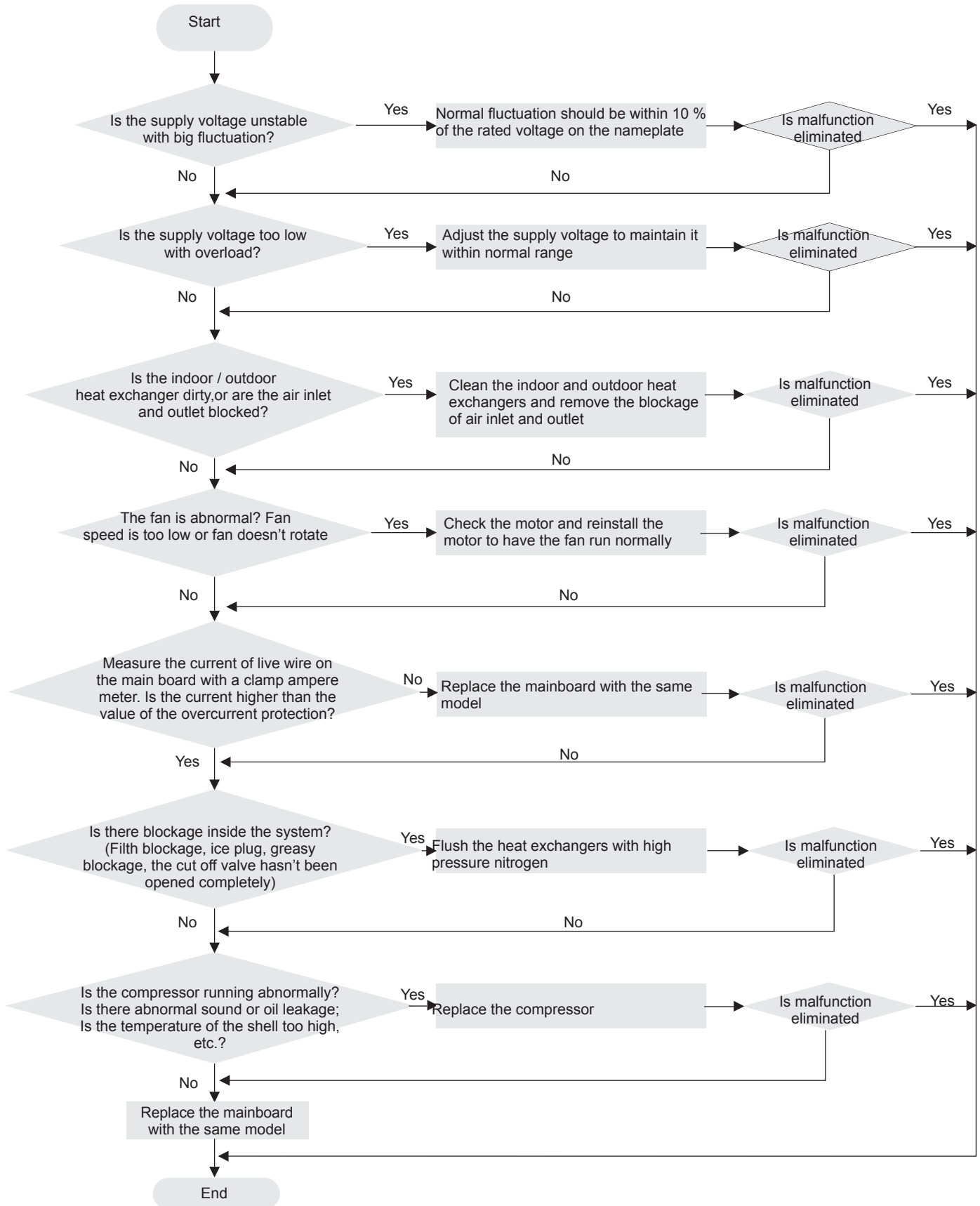

9. Maintenance

11. Malfunction of Blocked Protection of IDU Fan Motor H6

Main detection points:

- Smoothly Is the control terminal of PG motor connected tightly?
- Smoothly Is the feedback interface of PG motor connected tightly?
- The fan motor can't operate?
- The motor is broken?
- Detection circuit of the mainboard is defined abnormal?Malfunction

diagnosis process:

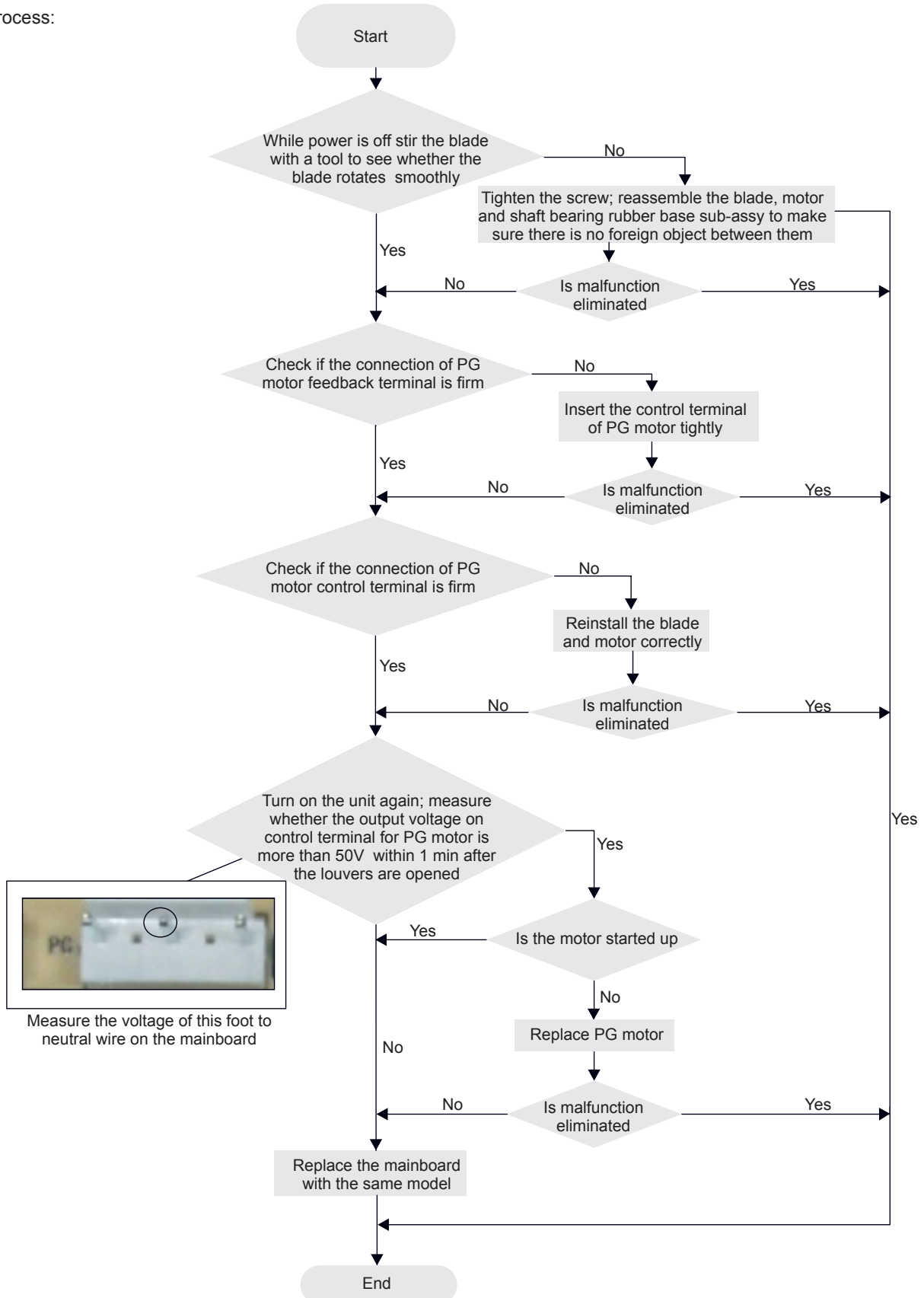

9. Maintenance

12. Capacity charging malfunction PU

(AP1 below means control board of outdoor unit) Main detection points:

Main detection points:

(1) wiring board XT (2) reactor Malfunction diagnosis process:

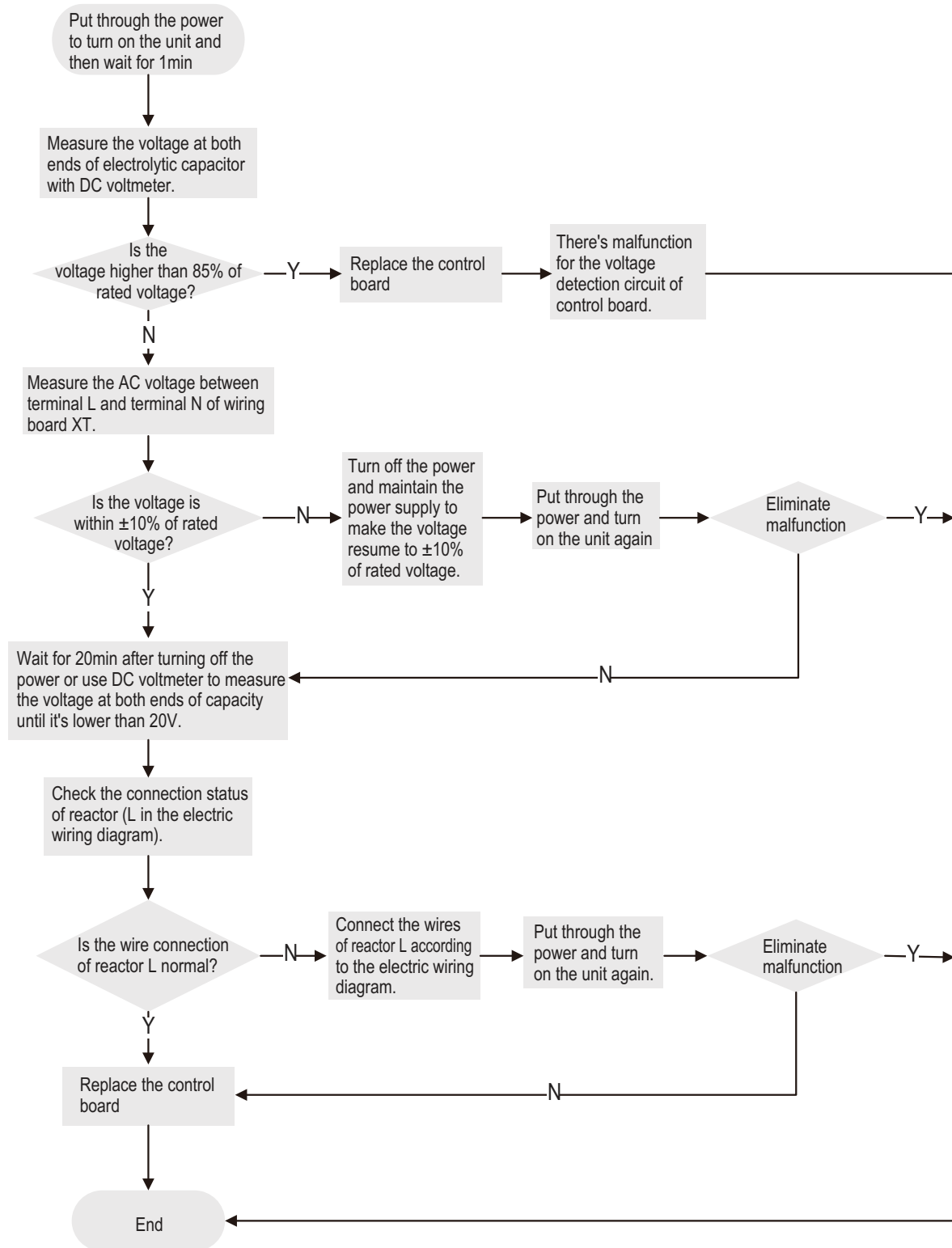

9. Maintenance

13. Malfunction of detecting plate(WIFI) JF

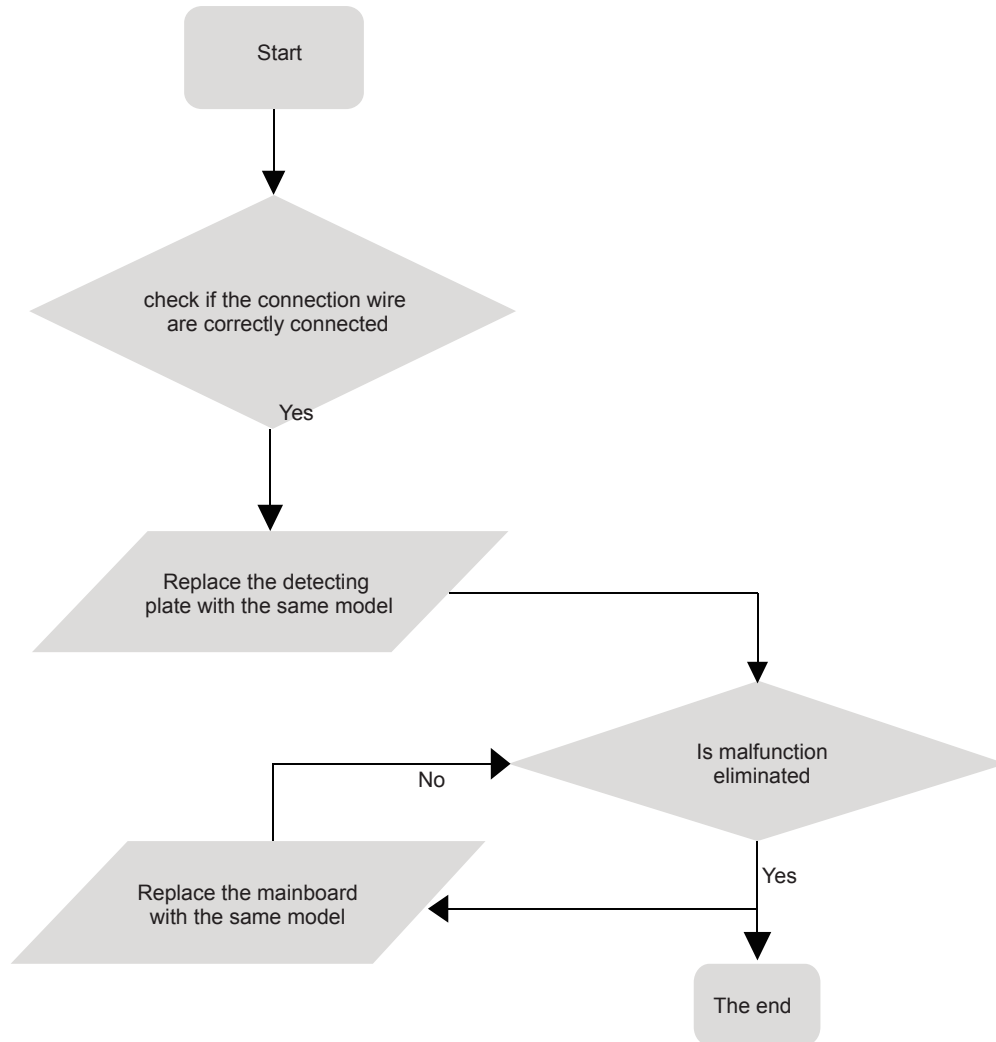

9. Maintenance

9.3 Troubleshooting for Normal Malfunction

1. Air Conditioner can't be Started Up

Possible Causes	Discriminating Method (Air conditioner Status)	Troubleshooting
No power supply, or poor connection for power plug	After energization, operation indicator isn't bright and the buzzer can't give out sound	Confirm whether it's due to power failure. If yes, wait for power recovery. If not, check power supply circuit and make sure the power plug is connected well.
Wrong wire connection between indoor unit and outdoor unit, or poor connection for wiring terminals	Under normal power supply circumstances, operation indicator isn't bright after energization	Check the circuit according to circuit diagram and connect wires correctly. Make sure all wiring terminals are connected firmly
Electric leakage for air conditioner	After energization, room circuit breaker trips off at once	Make sure the air conditioner is grounded reliably Make sure wires of air conditioner is connected correctly Check the wiring inside air conditioner. Check whether the insulation layer of power cord is damaged; if yes, place the power cord.
Model selection for air switch is improper	After energization, air switch trips off	Select proper air switch
Malfunction of remote controller	After energization, operation indicator is bright, while no display on remote controller or buttons have no action.	Replace batteries for remote controller Repair or replace remote controller

2. Poor Cooling (Heating) for Air Conditioner

Possible Causes	Discriminating Method (Air conditioner Status)	Troubleshooting
Set temperature is improper	Observe the set temperature on remote controller	Adjust the set temperature
Rotation speed of the IDU fan motor is set too low	Small wind blow	Set the fan speed at high or medium
Filter of indoor unit is blocked	Check the filter to see it's blocked	Clean the filter
Installation position for indoor unit and outdoor unit is improper	Check whether the installation position is proper according to installation requirement for air conditioner	Adjust the installation position, and install the rainproof and sunproof for outdoor unit
Refrigerant is leaking	Discharged air temperature during cooling is higher than normal discharged wind temperature; Discharged air temperature during heating is lower than normal discharged wind temperature; Units pressure is much lower than regulated range	Find out the leakage causes and deal with it. Add refrigerant.
Malfunction of 4-way valve	Blow cold wind during heating	Replace the 4-way valve
Malfunction of capillary	Discharged air temperature during cooling is higher than normal discharged wind temperature; Discharged air temperature during heating is lower than normal discharged wind temperature; Unit pressure is much lower than regulated range. If refrigerant isn't leaking, part of capillary is blocked	Replace the capillary
Flow volume of valve is insufficient	The pressure of valves is much lower than that stated in the specification	Open the valve completely
Malfunction of horizontal louver	Horizontal louver can't swing	Refer to point 3 of maintenance method for details
Malfunction of the IDU fan motor	The IDU fan motor can't operate	Refer to troubleshooting for H6 for maintenance method in details
Malfunction of the ODU fan motor	The ODU fan motor can't operate	Refer to point 4 of maintenance method for details
Malfunction of compressor	Compressor can't operate	Refer to point 5 of maintenance method for details

3. Horizontal Louver can't Swing

Possible Causes	Discriminating Method (Air conditioner Status)	Troubleshooting
Wrong wire connection, or poor connection	Check the wiring status according to circuit diagram	Connect wires according to wiring diagram to make sure all wiring terminals are connected firmly
Stepping motor is damaged	Stepping motor can't operate	Repair or replace stepping motor
Main board is damaged	Others are all normal, while horizontal louver can't operate	Replace the main board with the same model

9. Maintenance

4. ODU Fan Motor can't Operate

Possible causes	Discriminating method (air conditioner status)	Troubleshooting
Wrong wire connection, or poor connection	Check the wiring status according to circuit diagram	Connect wires according to wiring diagram to make sure all wiring terminals are connected firmly
Capacity of the ODU fan motor is damaged	Measure the capacity of fan capacitor with an universal meter and find that the capacity is out of the deviation range indicated on the nameplate of fan capacitor.	Replace the capacity of fan
Power voltage is a little low or high	Use universal meter to measure the power supply voltage. The voltage is a little high or low	Suggest to equip with voltage regulator
Motor of outdoor unit is damaged	When unit is on, cooling/heating performance is bad and ODU compressor generates a lot of noise and heat.	Change compressor oil and refrigerant. If no better, replace the compressor with a new one

5. Compressor can't Operate

Possible causes	Discriminating method (air conditioner status)	Troubleshooting
Wrong wire connection, or poor connection	Check the wiring status according to circuit diagram	Connect wires according to wiring diagram to make sure all wiring terminals are connected firmly
Capacity of compressor is damaged	Measure the capacity of fan capacitor with an universal meter and find that the capacity is out of the deviation range indicated on the nameplate of fan capacitor.	Replace the compressor capacitor
Power voltage is a little low or high	Use universal meter to measure the power supply voltage. The voltage is a little high or low	Suggest to equip with voltage regulator
Coil of compressor is burnt out	Use universal meter to measure the resistance between compressor terminals and it's 0	Repair or replace compressor
Cylinder of compressor is blocked	Compressor can't operate	Repair or replace compressor

6. Air Conditioner is Leaking

Possible causes	Discriminating method (air conditioner status)	Troubleshooting
Drain pipe is blocked	Water leaking from indoor unit	Eliminate the foreign objects inside the drain pipe
Drain pipe is broken	Water leaking from drain pipe	Replace drain pipe
Wrapping is not tight	Water leaking from the pipe connection place of indoor unit	Wrap it again and bundle it tightly

7. Abnormal Sound and Vibration

Possible causes	Discriminating method (air conditioner status)	Troubleshooting
When turn on or turn off the unit, the panel and other parts will expand and There's abnormal sound	There's the sound of "PAPA"	Normal phenomenon. Abnormal sound will disappear after a few minutes.
When turn on or turn off the unit, There's abnormal sound due to flow of refrigerant inside air conditioner	Water-running sound can be heard	Normal phenomenon. Abnormal sound will disappear after a few minutes.
Foreign objects inside the indoor unit or there're parts touching together inside the indoor unit	There's abnormal sound fro indoor unit	Remove foreign objects. Adjust all parts position of indoor unit, tighten screws and stick damping plaster between connected parts
Foreign objects inside the outdoor unit or there're parts touching together inside the outdoor unit	There's abnormal sound fro outdoor unit	Remove foreign objects. Adjust all parts position of outdoor unit, tighten screws and stick damping plaster between connected parts
Short circuit inside the magnetic coil	During heating, the way valve has abnormal electromagnetic sound	Replace magnetic coil
Abnormal shake of compressor	Outdoor unit gives out abnormal sound	Adjust the support foot mat of compressor, tighten the bolts
Abnormal sound inside the compressor	Abnormal sound inside the compressor	If add too much refrigerant during maintenance, please reduce refrigerant properly. Replace compressor for other circumstances.

11. Removal Procedure

11.1 Removal Procedure of Indoor Unit

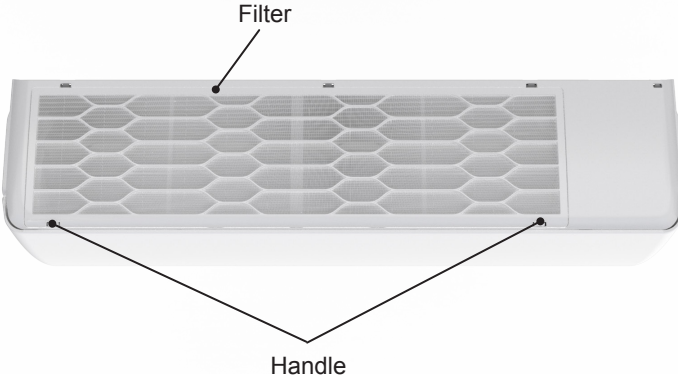
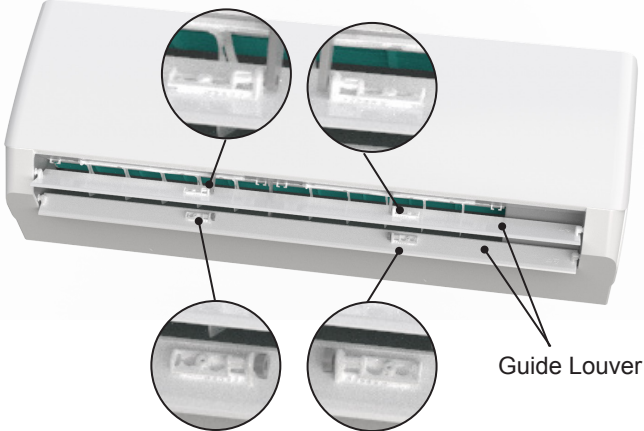

Caution: discharge the refrigerant completely before removal.

Step	Procedure
Before disassemble	 <p>Turn off the air conditioner and disconnect the power before disassemble the air conditioner.</p>
1. Remove filter	 <p>Hold the handle on the filter, pull it upwards to let the clasp at the top part of the filter loose, push it forwards and then the filter can be pulled out.</p>
2. Remove upper and lower guide louver	 <p>Push out the plug pin on upper and lower guide louver, Bend the guide louver with hand and then separate the guide louver from the crank shaft of step motor to remove it.</p>

11. Removal Procedure

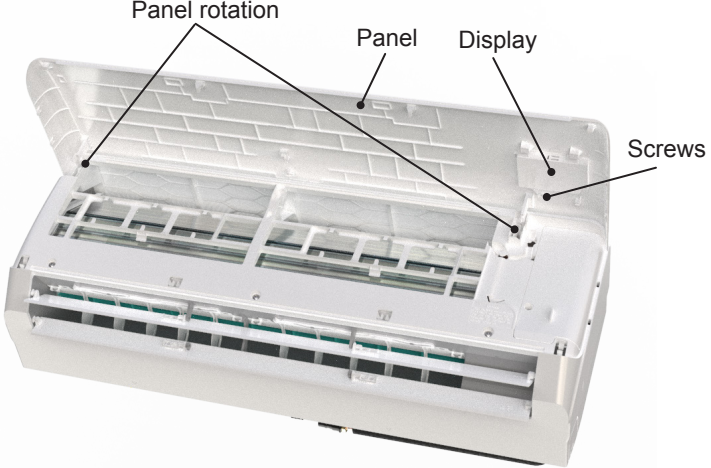
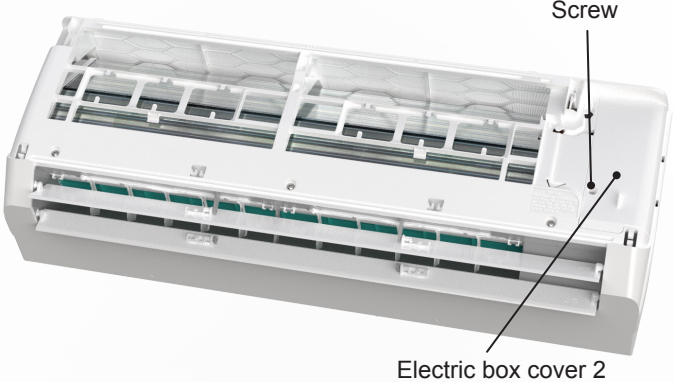
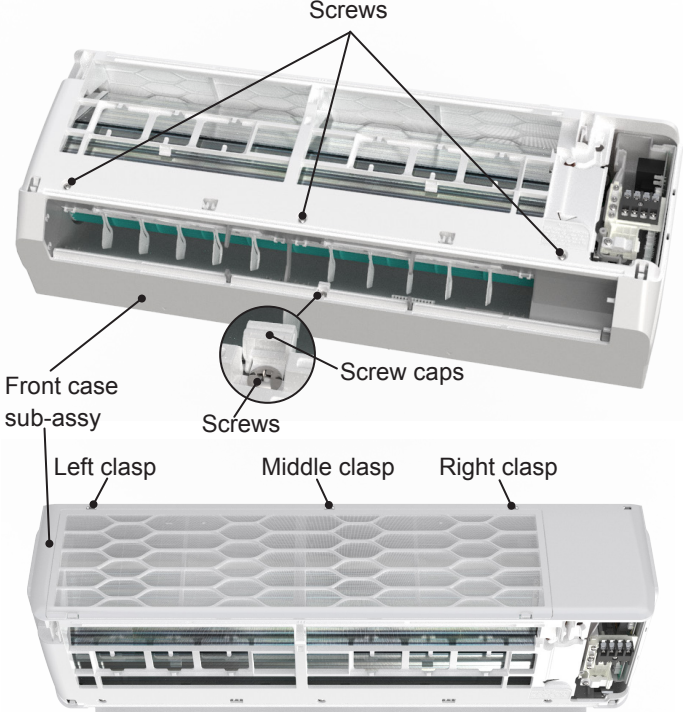
Step	Procedure
<p>3.Remove panel</p> <p>Open the front panel; separate the panel rotation shaft from the groove fixing the front panel and then removes the front panel.</p> <p>Note: The display of some models is fixed on the panel; unscrew the screws fixing the display on the panel before removing the panel.</p>	 <p>The diagram shows the front panel of the device being lifted away from the main unit. Labels point to the 'Panel rotation' mechanism at the top, the 'Panel' itself, the 'Display' area, and 'Screws' that hold the panel in place.</p>
<p>4.Remove electric box cover 2</p> <p>Remove the screws on the electric box cover 2 to remove the electric box cover 2.</p>	 <p>The diagram shows the 'Electric box cover 2' being removed from the back of the device. A 'Screw' is shown being removed from the cover.</p>
<p>5.Remove front case sub-assy</p> <p>a Remove the screws fixing front case.</p> <p>Note: (1) Open the screw caps before removing the screws around the air outlet. (2) The quantity of screws fixing the front case sub-assy is different for different models.</p> <p>b Loosen the clasps at left, middle and right sides of front case. Lift the front case sub-assy upwards to remove it.</p>	 <p>The diagram is split into two parts. Part (a) shows the 'Front case sub-assy' being held in place by 'Screws'. A circular inset shows a 'Screw cap' being removed. Part (b) shows the 'Front case sub-assy' being lifted away from the main unit, with labels for the 'Left clasp', 'Middle clasp', and 'Right clasp'.</p>

11. Removal Procedure

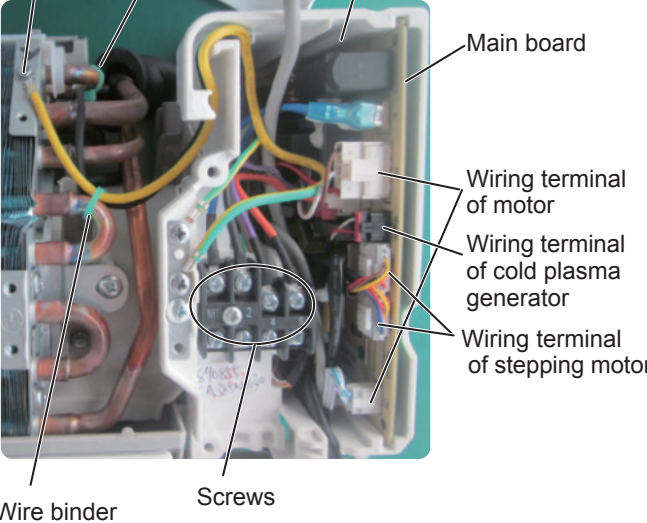
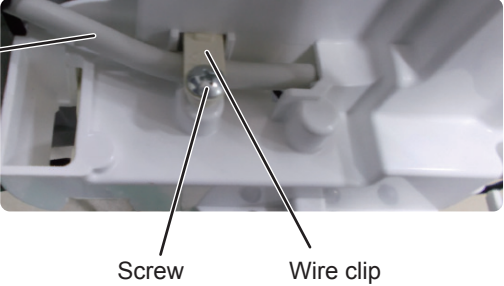
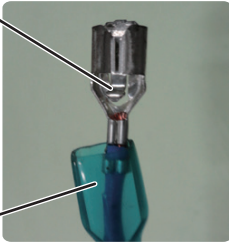
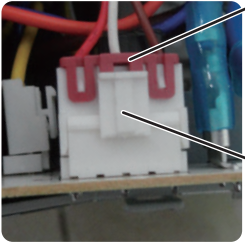
Step	Procedure
6.Remove electric box assy	
a	<p>Remove the screw fixing electric box assy.</p> 
b	<p>① Cut off the wire binder and pull out the indoor tube temperature sensor. ② Screw off one grounding screw. ③ Remove the wiring terminals of motor, cold plasma generator and stepping motor. ④ Remove the electric box assy. ⑤ Screw off the screws that are locking each.</p> 
c	<p>Rotate the electric box assy. Twist off the screws that are locking the wire clip and loosen the power cord. Remove the wiring terminal of power cord. Lift up the main board and take it off.</p>  <p>Instruction:Some wiring terminal of this products is with lock catch and other devices.The pulling method is as below: 1.Remove the soft sheath for some terminals at first, hold the circlip and then pull out the terminals, 2.Pull out the holder for some terminals at first(holder is not available for some wiring terminal).hold the connector and then pull the terminal.</p>  

11. Removal Procedure

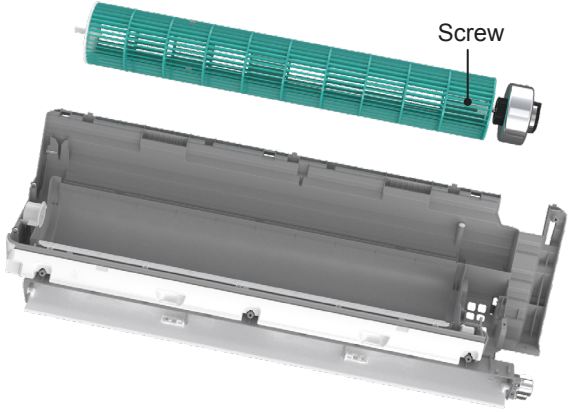
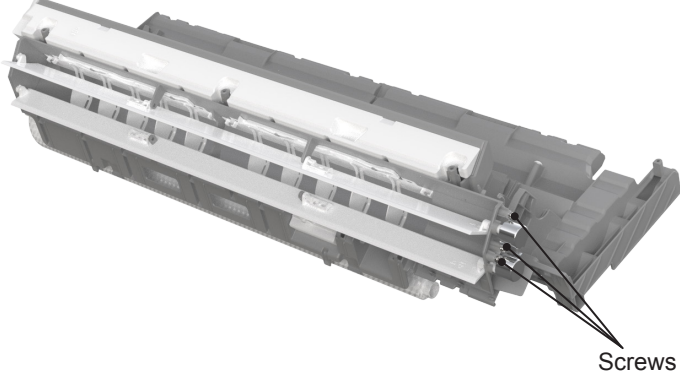
Step	Procedure
8. Remove motor and cross flow fan	
a	<p>Remove 3 screws fixing motor clamp and then remove the motor clamp.</p> 
b	<p>Loose the screws (2-3 circles) used for fixing the cross flow fan, pull right to pull out the motor.</p> 
9. Remove swing motor	
	<p>Screw off the screws that are locking the swing motor and take the motor off.</p> 

11. Removal Procedure

11.2 Removal Procedure of Outdoor Unit



Caution: discharge the refrigerant completely before removal.

09K

NOTE: Take heat pump for example.

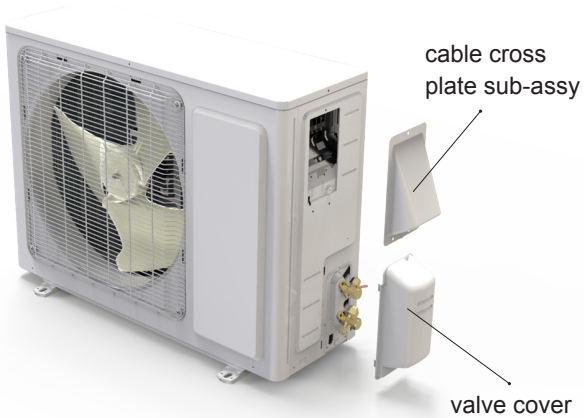
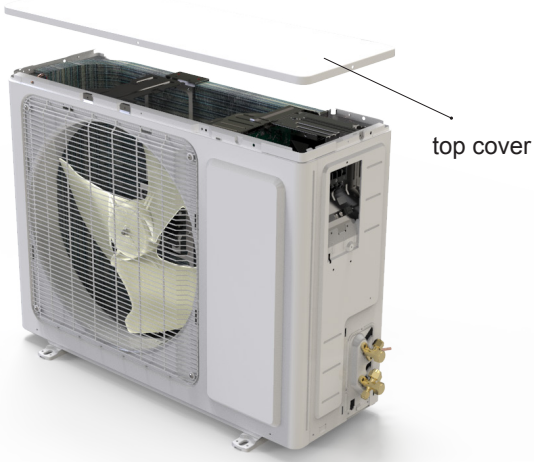
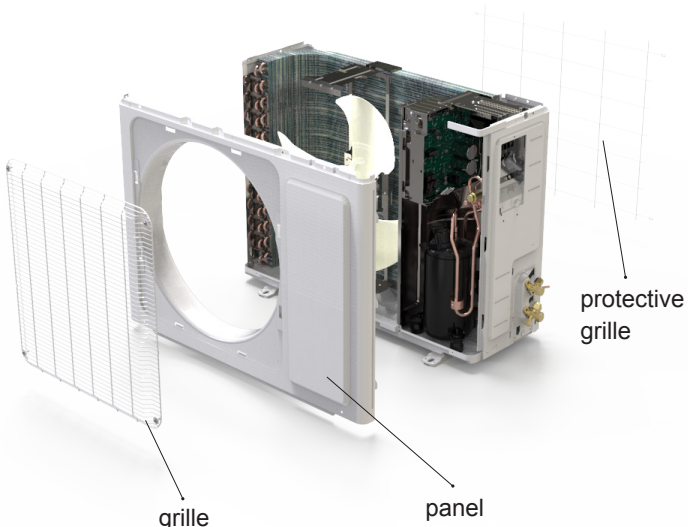
Step	Procedure
<p>1. Remove cable cross plate sub-assy and valve cover</p> <p>Remove the screws connecting cable cross plate sub-assy and right side plate, to remove the cable cross plate sub-assy. Remove the screw fixing valve cover, to remove the cover.</p>	 <p>The diagram shows the outdoor unit with the cable cross plate sub-assy and valve cover removed. Labels point to the 'cable cross plate sub-assy' and 'valve cover'.</p>
<p>2. Remove top cover</p> <p>Remove connection screws connecting the top panel with the front panel and the right side plate, and then remove the top panel.</p>	 <p>The diagram shows the outdoor unit with the top cover removed. A label points to the 'top cover'.</p>
<p>3. Remove grille, protective grille and front panel</p> <p>Remove connection screws between the front grille and the front panel. Then remove the front grille. Remove connection screws connecting the front panel with the chassis and the motor support, and then remove the front panel. Remove the screws fixing protective grille and then remove the protective grille.</p>	 <p>The diagram shows the outdoor unit with the grille, protective grille, and front panel removed. Labels point to the 'grille', 'panel', and 'protective grille'.</p>

11. Removal Procedure

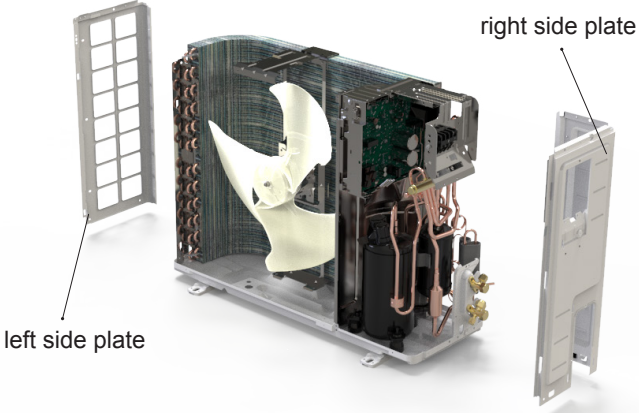
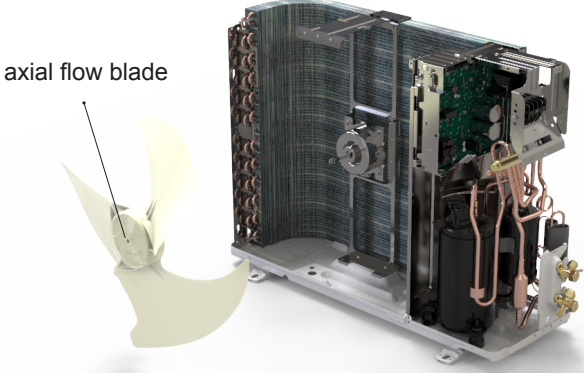
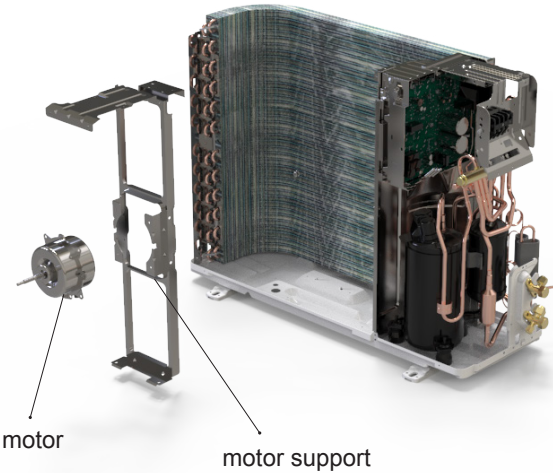
Step	Procedure
4.Remove right side plate, left side plate	<p>Remove the screws fixing right side plate, left side plate and then remove them.</p>  <p>left side plate</p> <p>right side plate</p>
5.Remove axial flow blade	<p>Remove the nut fixing the blade and then remove the axial flow blade.</p>  <p>axial flow blade</p>
6.Remove motor and motor support	<p>Remove the screws fixing motor and then remove the motor. Remove the screws fixing motor support and then remove the motor support.</p>  <p>motor</p> <p>motor support</p>

11. Removal Procedure

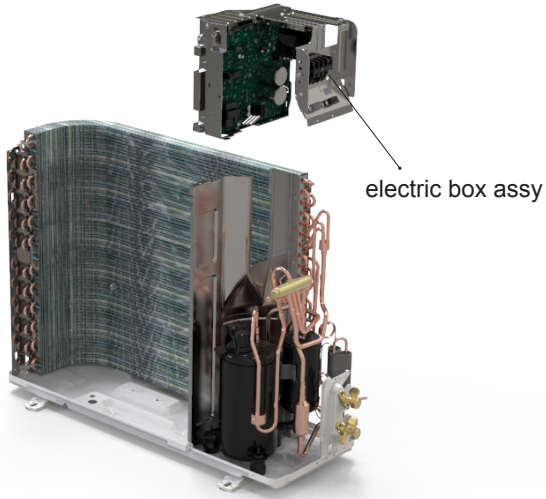
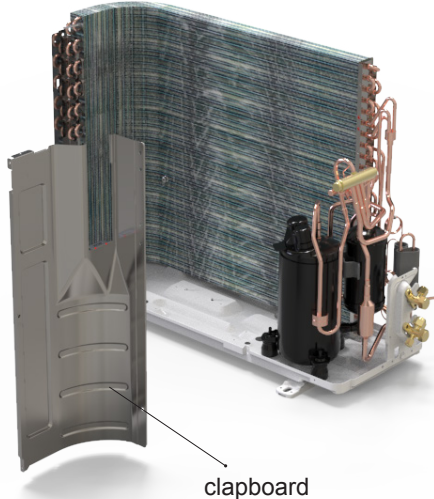
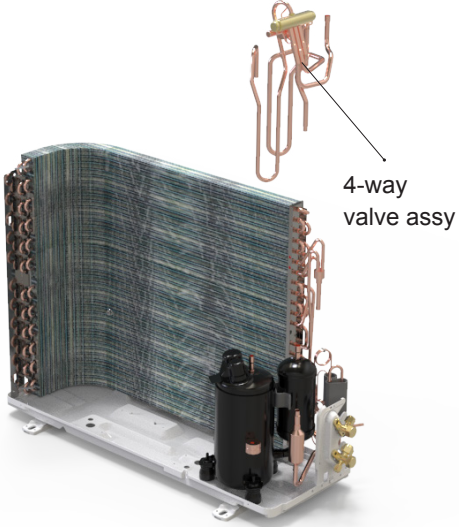
Step	Procedure
7. Remove electric box assy	 <p>Remove the screws fixing electric box assy; cut off the tieline; pull out each wiring terminal; lift the electric box assy upwards to remove it.</p> <p>Note: When pulling out the wiring terminal, pay attention to loose the clasp and don't pull it so hard.</p>
8. Remove clapboard	 <p>Remove the screws fixing clapboard and then remove the clapboard.</p>
9. Remove 4-way valve assy	 <p>Unsolder the welding joints connecting the 4-way valve assy with capillary sub-assy, compressor and condenser; remove the 4-way valve. Cooling only unit removes Discharge Tube and Inhalation Tube</p> <p>Note: Before unsoldering the welding joint, wrap the 4-way valve with a wet cloth completely to avoid damage to the valve caused by high temperature.</p>

11. Removal Procedure

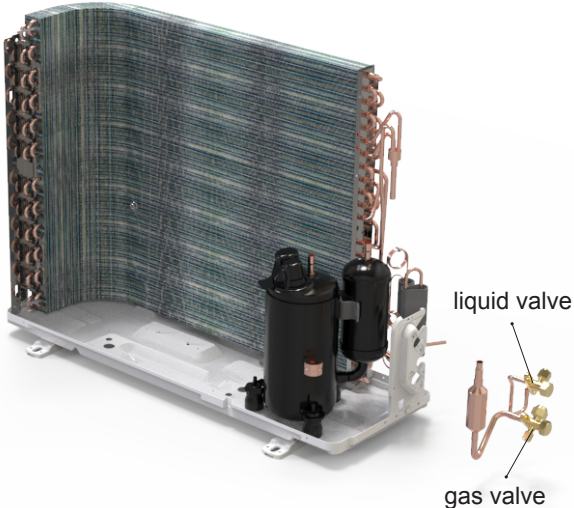
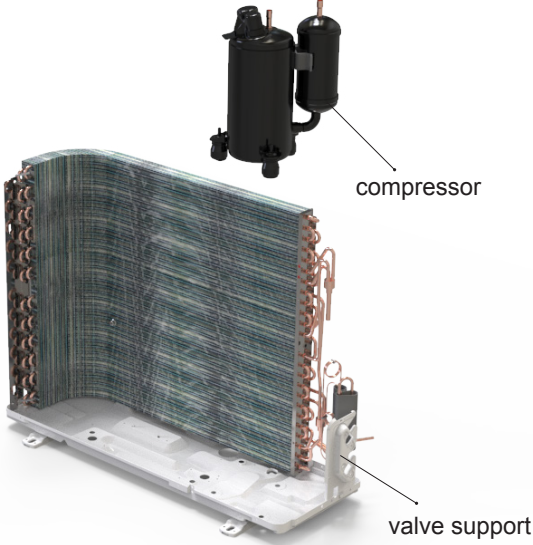
Step	Procedure
10.Remove liquid valve and gas valve	 <p>Unsolder the welding joint connecting the valve with capillary and condenser; unsolder the welding joint connecting the gas valve and air-return pipe; remove the 2 screws fixing the gas valve to remove the gas valve.</p> <p>Unsolder the welding joint connecting the liquid valve and Y-shaped pipe; remove the 2 screws fixing the liquid valve to remove the liquid valve.</p> <p>Note: Before unsoldering the welding joint, wrap the gas valve with a wet cloth completely to avoid damage to the valve caused by high temperature.</p>
11.Remove compressor	 <p>Remove the 3 footing screws of the compressor and remove the compressor.</p> <p>Remove the screws fixing valve support and then remove the valve support.</p>

11. Removal Procedure

12K

NOTE:Take heat pump for example.

Step	Procedure
1. Remove big handle	
a	<p>Before disassemble</p> 
b	<p>Remove 3 connection screw fixing cable cross plate 2 and then remove the cable cross plate 2.</p> <p>Remove 1 connection screw fixing valve cover and then remove the valve cover.</p> 
2. Remove top cover	
	<p>Remove the screws fixing top panel and then remove the top panel.</p> 

11. Removal Procedure

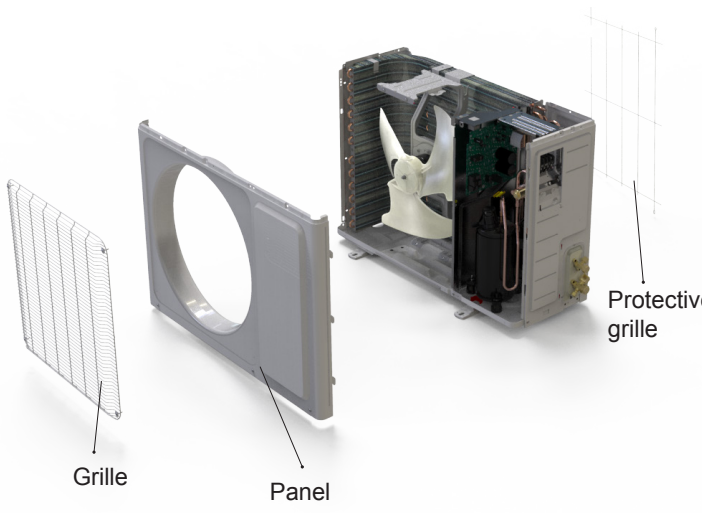
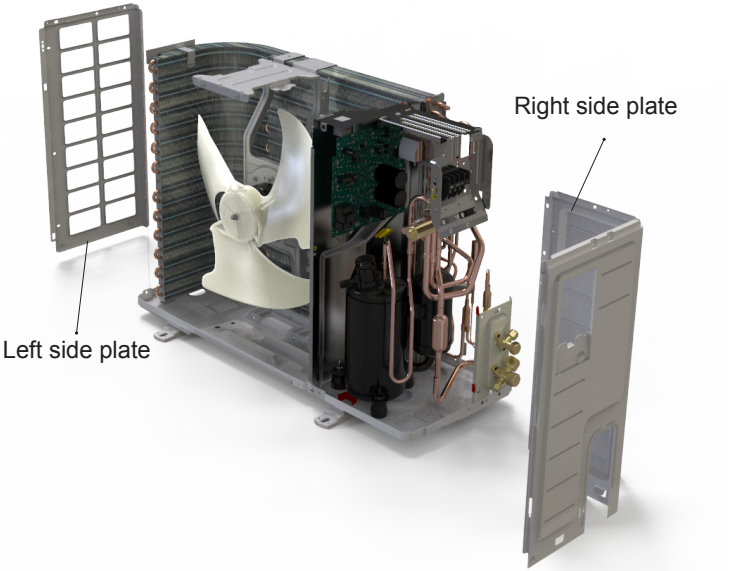
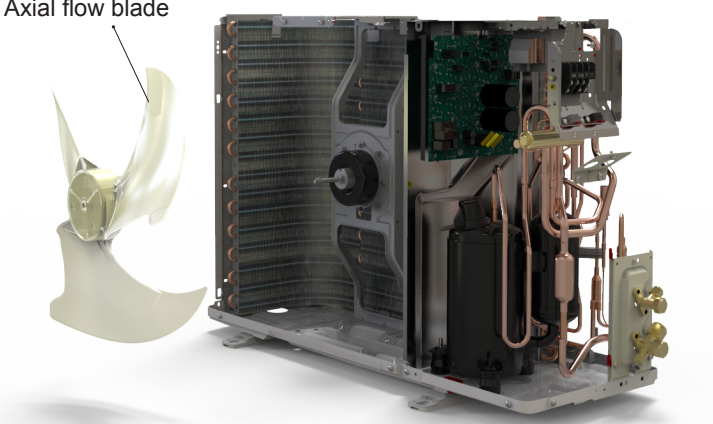
Step	Procedure
3.Remove grille and protective grille and front panel	<p>Remove connection screws between the front grille and the front panel. Then remove the front grille.</p> <p>Remove connection screws connecting the front panel with the chassis and the motor support, and then remove the front panel.</p> <p>Remove the screws fixing protective grille and then remove the protective grille.</p>  <p>The diagram illustrates the removal of the front grille and panel. It shows three components: a wire mesh grille, a grey plastic front panel with a circular cutout, and the main unit with the protective grille removed. Labels point to 'Grille', 'Panel', and 'Protective grille'.</p>
4.Remove right side plate and left side plate	<p>Remove the screws fixing right side plate and left side plate and then remove them.</p>  <p>The diagram shows the unit with the side plates removed. The left side plate is a dark grey frame with a grid pattern, and the right side plate is a solid grey panel. Labels point to 'Left side plate' and 'Right side plate'.</p>
5.Remove axial flow blade	<p>Remove the nut fixing the blade and then remove the axial flow blade.</p>  <p>The diagram shows the axial flow blade being removed from the unit. The blade is a white, curved component. A label points to 'Axial flow blade'.</p>

11. Removal Procedure

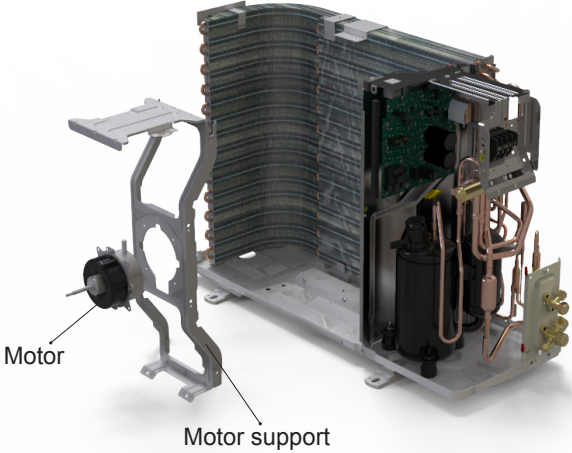
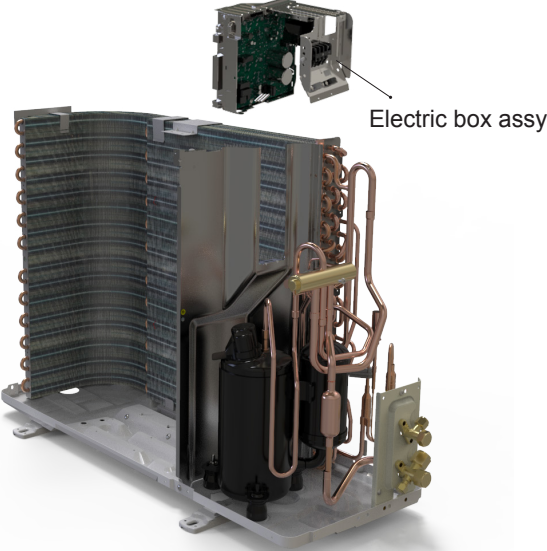
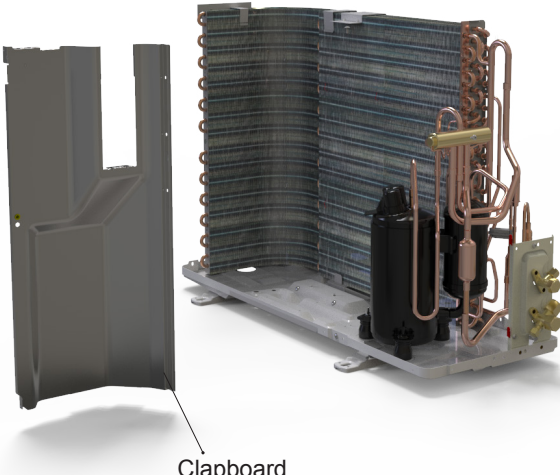
Step	Procedure
6. Remove motor and motor support	 <p>Remove the screws fixing motor and then remove the motor. Remove the screws fixing motor support and then remove the motor support.</p> <p>Motor Motor support</p>
7. Remove electric box assy	 <p>Remove the screws fixing electric box assy; cut off the tieline; pull out each wiring terminal; lift the electric box assy upwards to remove it. Note: When pulling out the wiring terminal, pay attention to loose the clasp and don't pull it so hard.</p> <p>Electric box assy</p>
8. Remove clapboard	 <p>Remove the screws fixing clapboard and then remove the clapboard.</p> <p>Clapboard</p>

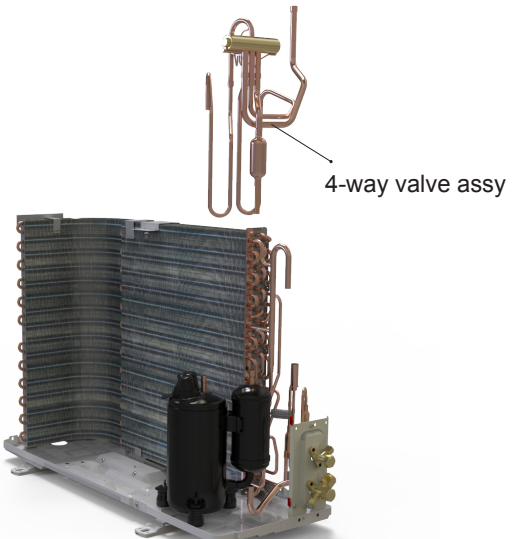
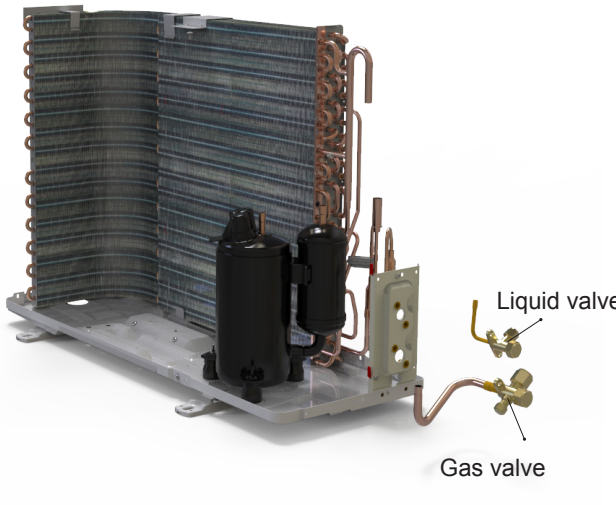
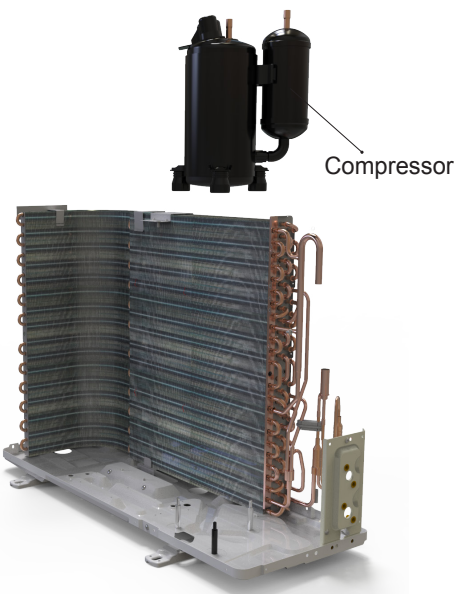

11. Removal Procedure

Step	Procedure
9.Remove 4-way valve assy	 <p>4-way valve assy</p> <p>Unsolder the welding joints connecting the 4-way valve assy with capillary sub-assy, compressor and condenser; remove the 4-way valve.</p> <p>Note: Before unsoldering the welding joint, wrap the 4-way valve with a wet cloth completely to avoid damage to the valve caused by high temperature.</p>
10.Remove liquid valve and gas valve	 <p>Liquid valve Gas valve</p> <p>Unsolder the welding joint connecting the valve with capillary and condenser; unsolder the welding joint connecting the gas valve and air-return pipe; Remove the 2 screws fixing the gas valve to remove the gas valve.</p> <p>Unsolder the welding joint connecting the liquid valve and Y-shaped pipe; remove the 2 screws fixing the liquid valve to remove the liquid valve.</p> <p>Note: Before unsoldering the welding joint, wrap the gas valve with a wet cloth completely to avoid damage to the valve caused by high temperature.</p>
11.Remove compressor	 <p>Compressor</p> <p>Remove the 3 footing screws of the compressor and remove the compressor; Remove the screws fixing valve support and then remove the valve support.</p>

11. Removal Procedure

18K

NOTE: Take heat pump for example.

Step	Procedure
1. Remove big handle, valve cover and top cover	
a	<p>Remove the screw connecting the big handle and right side plate, and then remove the big handle. Remove the screw connecting the valve cover and right side plate, and then remove the valve cover.</p>  <p>Big handle Valve cover</p>
b	<p>Remove the screws connecting the top cover with outer case, right side plate and left side plate; lift the top cover upwards to remove it.</p>  <p>Top cover</p>
2. Remove grille and outer case	
	<p>Remove the 4 screws connecting the grille and outer case, and then remove the panel grille.</p>  <p>Grille</p>

11. Removal Procedure

Step	Procedure	Image
	<p>Remove the screws connecting the outer case with motor support, isolation plate and chassis; lift the outer case upwards; loosen the clasps of outer case with right side plate and left side plate, and then remove the outer case.</p>	 <p>Outer case</p>
3. Remove right&left side plate		
a	<p>Remove the screws connecting the right side plate with electric box assy, valve support, chassis and condenser side plate, and then remove the right side plate.</p>	 <p>Right side plate</p>
b	<p>Remove the screws connecting the left side plate with chassis, and then remove the left side plate.</p>	 <p>Left side plate</p>

11. Removal Procedure

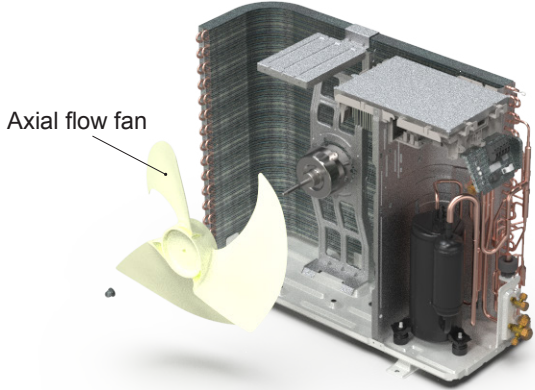
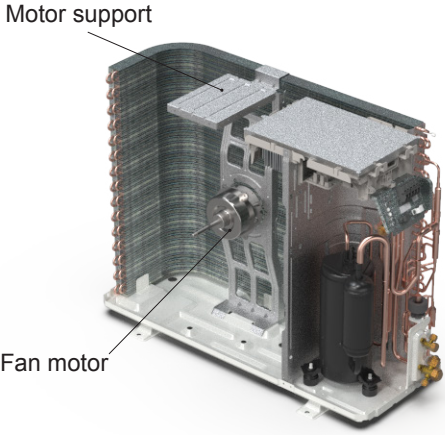
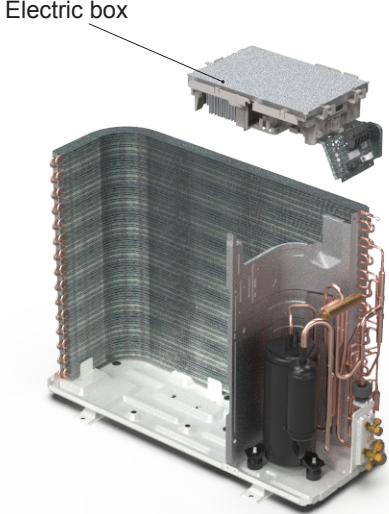
Step	Procedure
4. Remove axial flow blade	
a	<p>Remove the nut fixing axial flow blade and then remove the blade.</p>  <p>Axial flow fan</p>
b	<p>Remove the 6 screws fixing the motor and then remove the motor. Remove the 2 screws connecting the motor support and chassis, and then loosen the stopper to remove the motor support.</p>  <p>Motor support</p> <p>Fan motor</p>
5. Remove electric box	
	<p>Remove the screws fixing the electric box sub-assy; loosen the wire bundle; pull out the wiring terminals and then pull the electric box upwards to remove it.</p>  <p>Electric box</p>

11. Removal Procedure

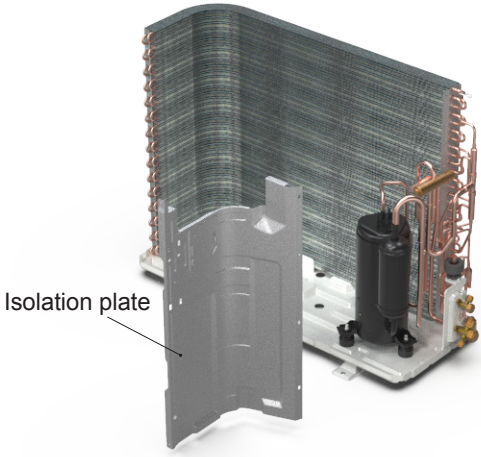
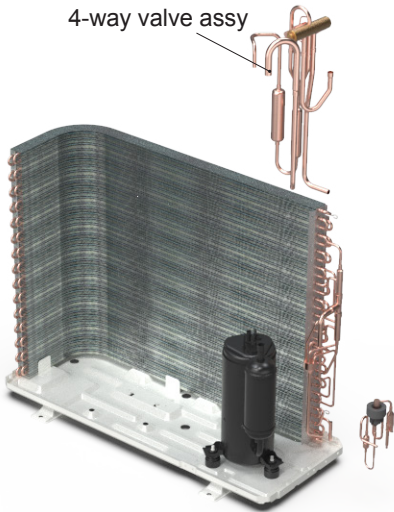
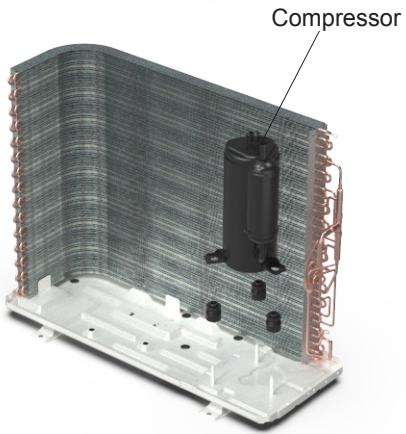
Step	Procedure
6. Remove isolation plate	<p>Remove the 2 screws connecting the isolation plate and condenser side plate; remove the 3 screws connecting the isolation plate and chassis, and then remove the isolation plate.</p>  <p>Isolation plate</p>
7. Remove 4-way valve assy	<p>Unsolder the welding joints connecting the 4-way valve assy with capillary sub-assy, compressor and condenser; remove the 4-way valve.</p> <p>Note: Before unsoldering the welding joint, wrap the 4-way valve with a wet cloth completely to avoid damage to the valve caused by high temperature.</p>  <p>4-way valve assy</p>
8. Remove compressor	<p>Remove the 3 foot nuts fixing compressor and then lift the compressor upwards to remove the compressor and damping cushion.</p> <p>Note: Keep the ports of discharge pipe and suction pipe from foreign objects.</p>  <p>Compressor</p>

11. Removal Procedure

24K

NOTE: Take heat pump for example.

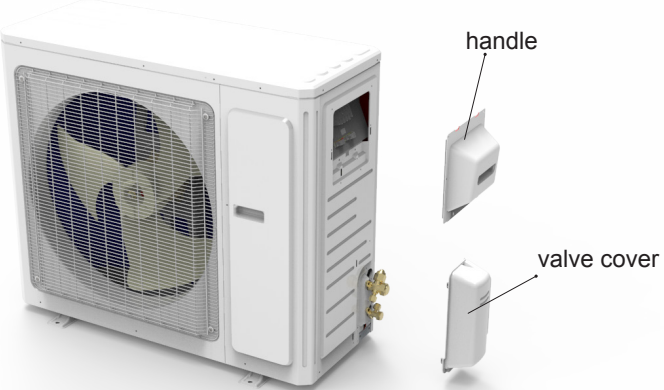
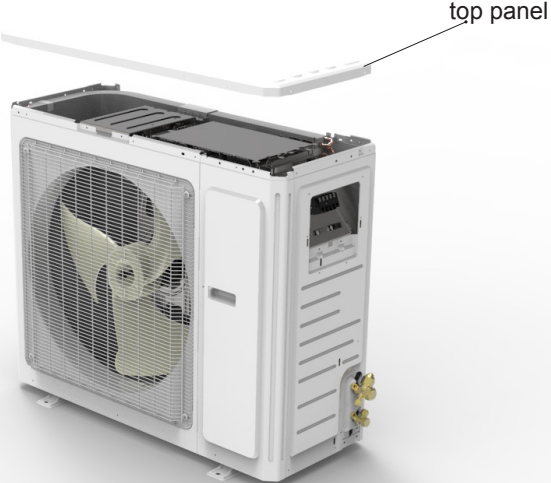
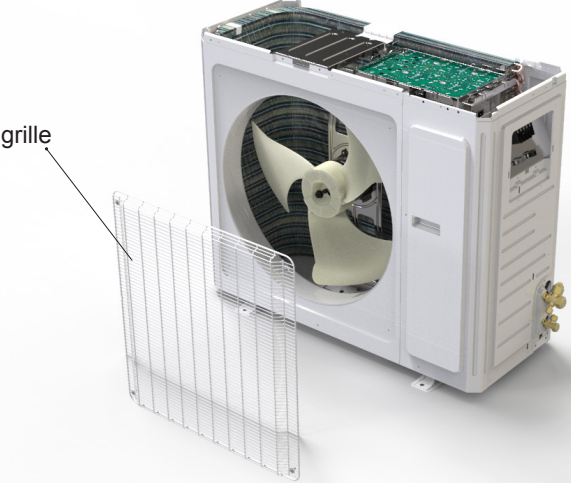
Step	Procedure
1. Remove handle and valve cover	 <p>Twist off the screws used for fixing the handle, pull the handle upward to remove it. Loosen the screws fixing the valve cover and then remove it.</p>
2. Remove top cover	 <p>Remove connection screws connecting the top cover plate with the front panel and the right side plate, and then remove the top cover.</p>
3. Remove front grill	 <p>Remove the screws connecting the front grill and the front panel. Remove the front grill.</p>

11. Removal Procedure

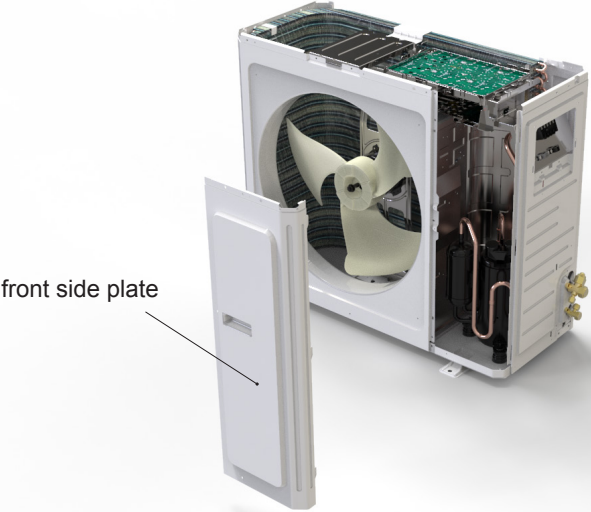
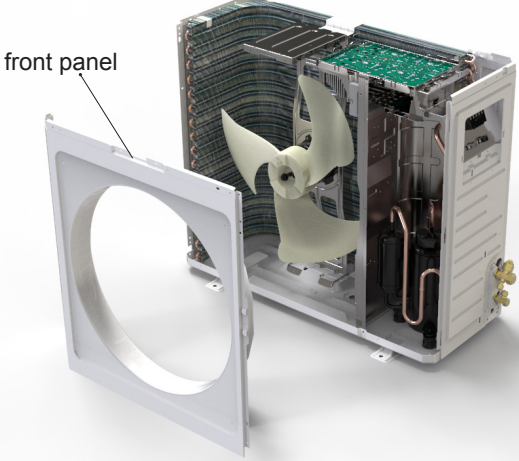
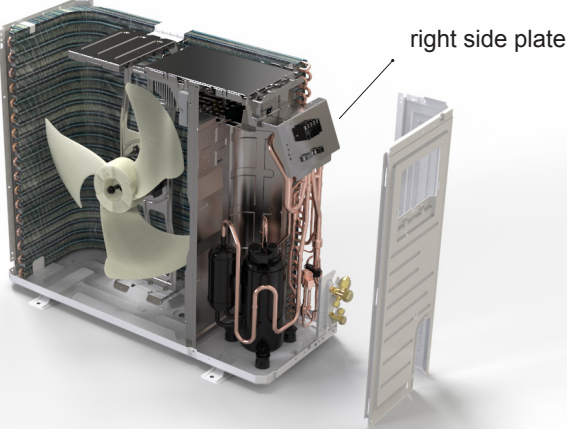
Step	Procedure	
4.Remove front side plate and front panel		
a	Remove screws connecting front side plate, outer case and chassis,and then remove the front side plate.	
b	Remove screws fixing front panel,chassis and motor support, and then remove the front panel.	
5.Remove right side plate		
	Remove screws connecting right side plate and chassis, valve support and condenser, and then remove the right side plate.	

11. Removal Procedure

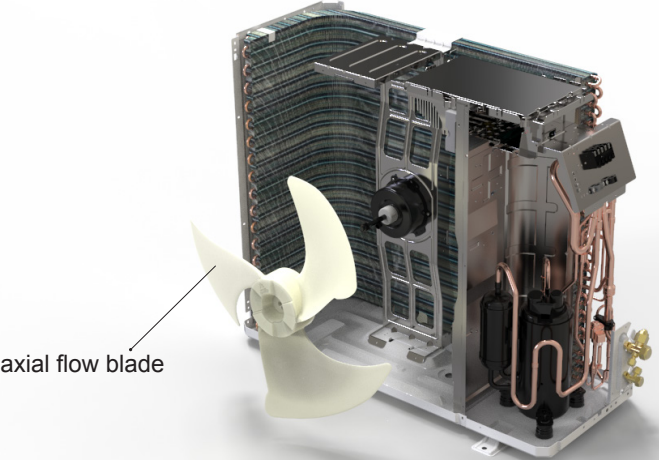
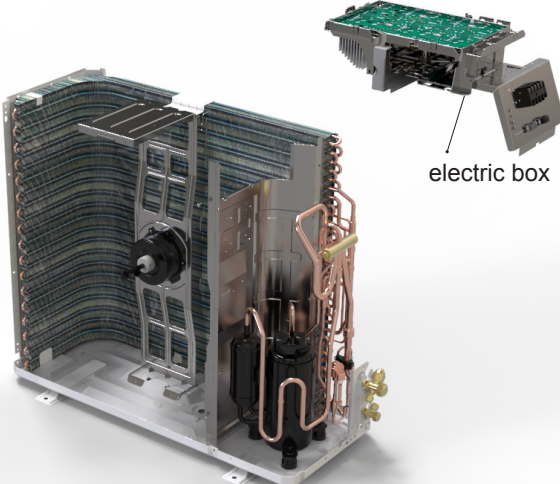
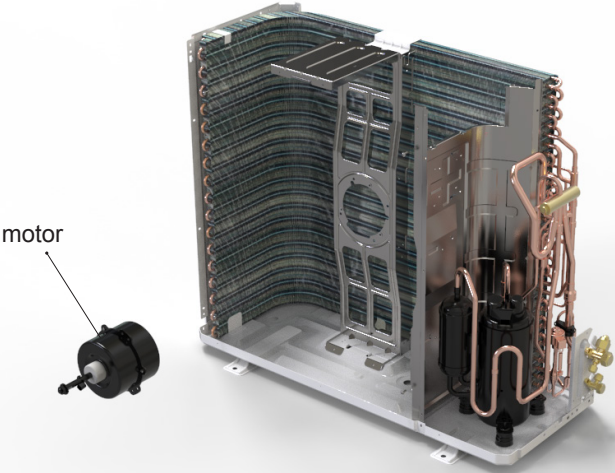
Step	Procedure
6. Remove axial flow blade	<p>Remove nut on blade with wrench, and then remove the axial flow blade.</p> 
7. Remove electric box and fireproof electric box	<p>Remove screws fixing electric box, cut off the tie wire with scissors, pull out the wiring terminal and then lift up the electric box to remove it. Twist off the screws on fireproof electric box and then remove the fireproof electric box.</p> 
8. Remove motor and motor support	<p>Twist off the tapping screws fixing the motor, pull out the pin of leading wire for motor and then remove the motor.</p> 

11. Removal Procedure

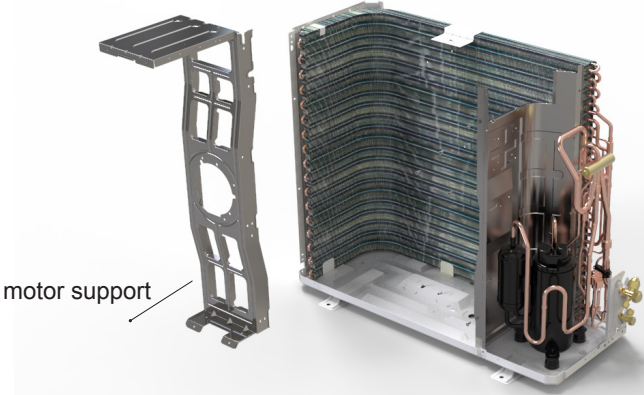
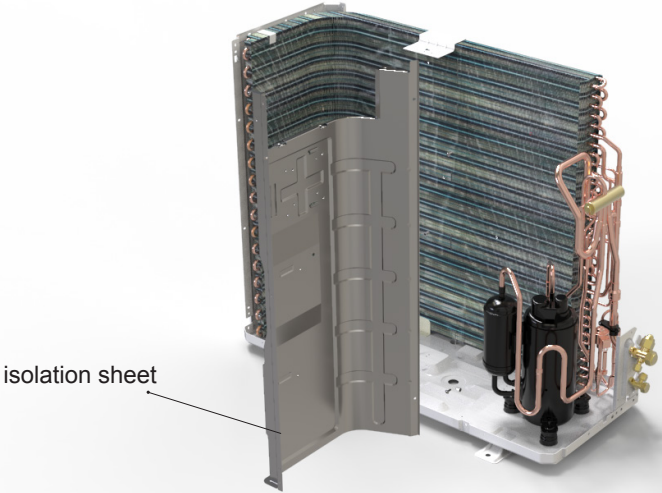
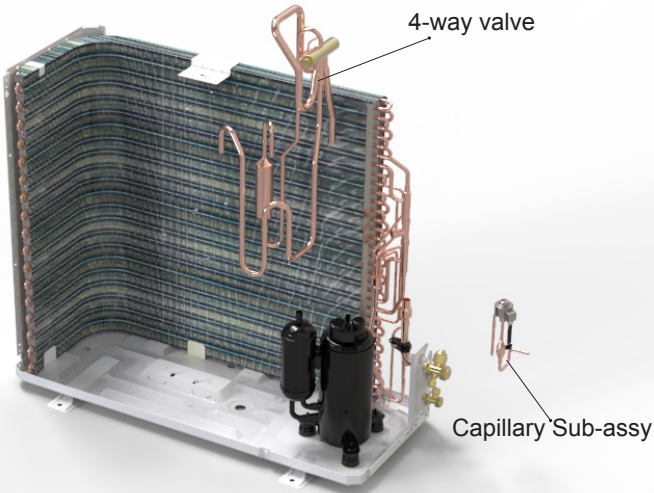
Step	Procedure	Image
b	Twist off the tapping screws fixing the motor support, pull it upwards and then remove the motor support.	 <p>motor support</p>
9.Remove isolation sheet		 <p>isolation sheet</p>
10.Remove 4-way valve		 <p>4-way valve</p> <p>Capillary Sub-assy</p>
	Unsolder the pipe line between compressor, condenser, gas and liquid valve, and then remove the 4-way valve. (note: release all refrigerant before unsoldering).	

11. Removal Procedure

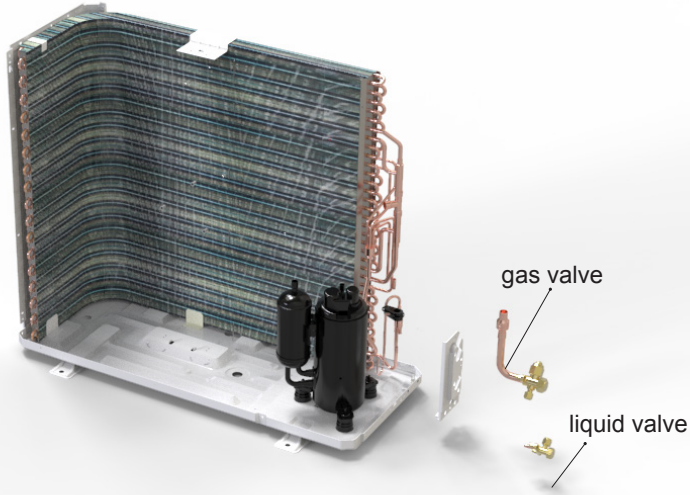
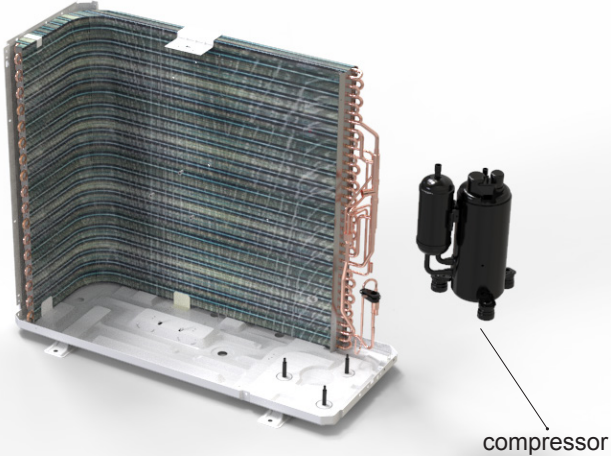
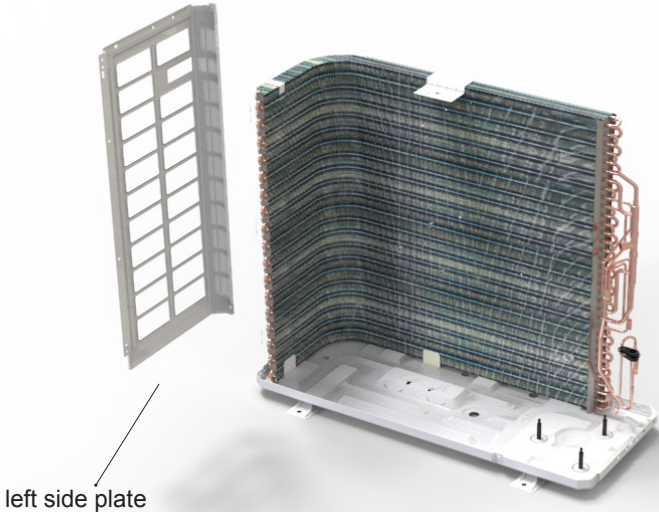
Step	Procedure
11.Remove gas valve and liquid valve	 <p>Twist off the 2 bolts fixing the valve sub-assy. Unsolder the soldering joint between gas valve and air-return pipe and then remove the gas valve. (note: when unsoldering the soldering joint, wrap the gas valve with wet cloth completely to avoid the damage to valve, and release all refrigerant completely at first). Unsolder the soldering joint between liquid valve and connection pipe of liquid valve, and then remove the liquid valve.</p> <p>Labels: gas valve, liquid valve</p>
12.Remove compressor	 <p>Twist off the 3 foot nuts on compressor and then remove the compressor.</p> <p>Label: compressor</p>
13.Remove left side plate	 <p>Twist off the screws connecting the left side plate and chassis with screwdriver, and then remove the left side plate.</p> <p>Label: left side plate</p>

Appendix:

Appendix 1: Reference Sheet of Celsius and Fahrenheit

Conversion formula for Fahrenheit degree and Celsius degree: $T_f = T_c \times 1.8 + 32$

Set temperature

Fahrenheit display temperature (°F)	Fahrenheit (°F)	Celsius (°C)	Fahrenheit display temperature (°F)	Fahrenheit (°F)	Celsius (°C)	Fahrenheit display temperature (°F)	Fahrenheit (°F)	Celsius (°C)
61	60.8	16	69/70	69.8	21	78/79	78.8	26
62/63	62.6	17	71/72	71.6	22	80/81	80.6	27
64/65	64.4	18	73/74	73.4	23	82/83	82.4	28
66/67	66.2	19	75/76	75.2	24	84/85	84.2	29
68	68	20	77	77	25	86	86	30

Ambient temperature

Fahrenheit display temperature (°F)	Fahrenheit (°F)	Celsius (°C)	Fahrenheit display temperature (°F)	Fahrenheit (°F)	Celsius (°C)	Fahrenheit display temperature (°F)	Fahrenheit (°F)	Celsius (°C)
32/33	32	0	55/56	55.4	13	79/80	78.8	26
34/35	33.8	1	57/58	57.2	14	81	80.6	27
36	35.6	2	59/60	59	15	82/83	82.4	28
37/38	37.4	3	61/62	60.8	16	84/85	84.2	29
39/40	39.2	4	63	62.6	17	86/87	86	30
41/42	41	5	64/65	64.4	18	88/89	87.8	31
43/44	42.8	6	66/67	66.2	19	90	89.6	32
45	44.6	7	68/69	68	20	91/92	91.4	33
46/47	46.4	8	70/71	69.8	21	93/94	93.2	34
48/49	48.2	9	72	71.6	22	95/96	95	35
50/51	50	10	73/74	73.4	23	97/98	96.8	36
52/53	51.8	11	75/76	75.2	24	99	98.6	37
54	53.6	12	77/78	77	25			

Appendix 2: Configuration of Connection Pipe

1. Standard length of connection pipe (More details please refer to the specifications.)

2. Min. length of connection pipe is 3m (10ft).

3. Max. length of connection pipe and max. high difference. (More details please refer to the specifications.)

4. The additional refrigerant oil and refrigerant charging required after prolonging connection pipe

- After the length of connection pipe is prolonged for 10m (33ft) at the basis of standard length, you should add 5ml (.17oz) of refrigerant oil for each additional 5m (16ft) of connection pipe.
- The calculation method of additional refrigerant charging amount (on the basis of liquid pipe):
- Basing on the length of standard pipe, add refrigerant according to the requirement as shown in the table. The additional refrigerant charging amount per meter is different according to the diameter of liquid pipe. See the following sheet.
- Additional refrigerant charging amount = prolonged length of liquid pipe X additional refrigerant charging amount per meter

Additional refrigerant charging amount for R22, R407C, R410A and R134a

Diameter of connection pipe		Outdoor unit throttle
Liquid pipe	Gas pipe	Heat Pump oz/ft (g/m)
1/4"	3/8" or 1/2"	.22 (20)
1/4" or 3/8"	5/8" or 3/4"	.54 (50)
1/2"	3/4" or 7/8"	1.29 (120)
5/8"	1" or 1 1/4"	1.29 (120)

Appendix:

Appendix 3: Pipe Expanding Method

⚠ Note:

Improper pipe expanding is the main cause of refrigerant leakage. Please expand the pipe according to the following steps:

A: Cut the pipe

- Confirm the pipe length according to the distance of indoor unit and outdoor unit.
- Cut the required pipe with pipe cutter.

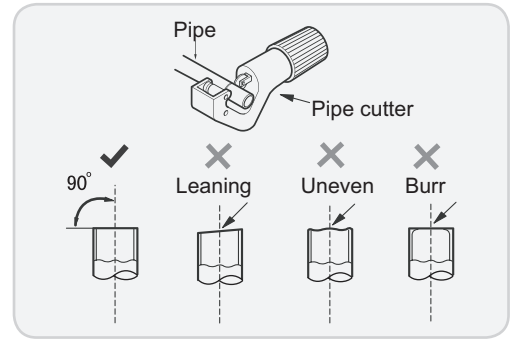

B: Remove the burrs

- Remove the burrs with shaper and prevent the burrs from getting into the pipe.

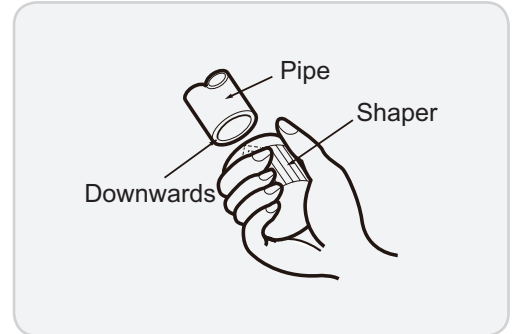

C: Put on suitable insulating pipe.

D: Put on the union nut

- Remove the union nut on the indoor connection pipe and outdoor valve; install the union nut on the pipe.

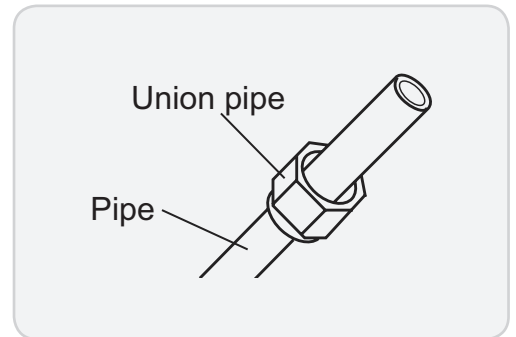

E: Expand the port

- Expand the port with expander.

⚠ Note:

- "A" is different according to the diameter, please refer to the sheet below:

Outer diameter mm(in)	A mm(in)	
	Max	Min
Φ6 - 6.35 (1/4")	1.3(.05)	0.7(.03)
Φ9.52 (3/8")	1.6(.06)	1.0(.04)
Φ12 - 12.70 (1/2")	1.8(.07)	1.0(.04)
Φ16 - 15.88 (5/8")	2.4(.1)	2.2(.09)

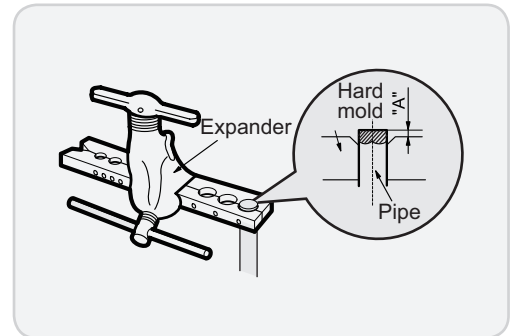

F: Inspection

- Check the quality of expanding port. If there is any blemish, expand the port again according to the steps above.

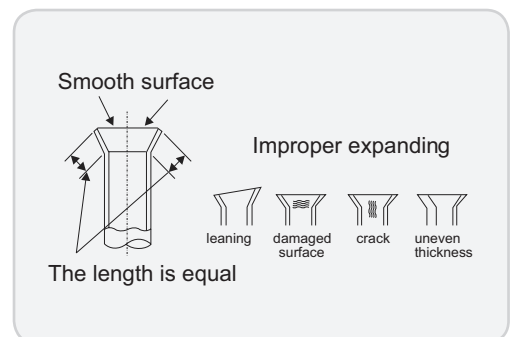

Appendix:

Appendix 4: List of Resistance for Temperature Sensor

Resistance Table of Ambient Temperature Sensor for Indoor and Outdoor Units(15K)

Temp(°C)	Resistance(kΩ)	Temp(°C)	Resistance(kΩ)	Temp(°C)	Resistance(kΩ)	Temp(°C)	Resistance(kΩ)
-19	138.10	0	49.02	20	18.75	40	7.97
-18	128.60	2	44.31	22	17.14	42	7.35
-16	115.00	4	40.09	24	15.68	44	6.79
-14	102.90	6	36.32	26	14.36	46	6.28
-12	92.22	8	32.94	28	13.16	48	5.81
-10	82.75	10	29.90	30	12.07	50	5.38
-8	74.35	12	27.18	32	11.09	52	4.99
-6	66.88	14	24.73	34	10.20	54	4.63
-4	60.23	16	22.53	36	9.38	56	4.29
-2	54.31	18	20.54	38	8.64	58	3.99

Resistance Table of Tube Temperature Sensors for Indoor and Outdoor (20K)

Temp(°C)	Resistance(kΩ)	Temp(°C)	Resistance(kΩ)	Temp(°C)	Resistance(kΩ)	Temp(°C)	Resistance(kΩ)
-19	181.40	20	25.01	60	4.95	100	1.35
-15	145.00	25	20.00	65	4.14	105	1.16
-10	110.30	30	16.10	70	3.48	110	1.01
-5	84.61	35	13.04	75	2.94	115	0.88
0	65.37	40	10.62	80	2.50	120	0.77
5	50.87	45	8.71	85	2.13	125	0.67
10	39.87	50	7.17	90	1.82	130	0.59
15	31.47	55	5.94	95	1.56	135	0.52

Resistance Table of Discharge Temperature Sensor for Outdoor(50K)

Temp(°C)	Resistance(kΩ)	Temp(°C)	Resistance(kΩ)	Temp(°C)	Resistance(kΩ)	Temp(°C)	Resistance(kΩ)
-30	911.400	10	98	50	17.65	90	4.469
-25	660.8	15	77.35	55	14.62	95	3.841
-20	486.5	20	61.48	60	12.17	100	3.315
-15	362.9	25	49.19	65	10.18	105	2.872
-10	274	30	39.61	70	8.555	110	2.498
-5	209	35	32.09	75	7.224	115	2.182
0	161	40	26.15	80	6.129	120	1.912
5	125.1	45	21.43	85	5.222	125	1.682



U.S. CONTACT INFORMATION TRADEWINDS, LLC

E-mail: info@twclimate.com

Contractor Support: 888-850-7928 | Mon-Fri 8 AM - 5 PM EDT

GREECOMFORT.COM