



U Match

CEILING CASSETTE INSTALLATION MANUAL

Models:

Indoor Unit

UMAT18HP230V1AC

UMAT24HP230V1AC

UMAT30HP230V1AC

UMAT36HP230V1AC

UMAT42HP230V1AC

UMAT48HP230V1AC

Outdoor Unit

UMAT18HP230V1AO

UMAT24HP230V1AO

UMAT30HP230V1AO

UMAT36HP230V1AO

UMAT42HP230V1AO

UMAT48HP230V1AO



Thank you for choosing a U-Match Ceiling Cassette Ductless Heat Pump System for your customer.

Please read this installation manual carefully before installing and starting up the Ceiling Cassette Ductless System. Take a moment to fill out the product and installation form on the back cover. Retain both the manual and installation record for future reference.

Table of Contents

<i>Safety Precautions</i>	2
<i>Nomenclature</i>	3
<i>System Requirements</i>	4
<i>Suggested Tools</i>	5
<i>System Schematic</i>	6
<i>Standard Parts</i>	7
<i>Installation Site Instructions</i>	8-9
<i>Indoor Unit Installation</i>	10-12
<i>Outdoor Unit Installation</i>	13-14
<i>Piping Installation</i>	15-18
<i>Power & Wiring</i>	19-21
<i>Controller Installation and Setup</i>	22-23
<i>Ceiling Cassette Panel Display</i>	23
<i>Fresh Air Intake</i>	24
<i>Decorative Grille Installation</i>	25
<i>Testing and Inspection</i>	26-28
<i>Troubleshooting</i>	29-30
<i>Diagnostic Codes</i>	31-33
<i>Warranty</i>	Back

SAFETY PRECAUTIONS

Please read the following before installation.



This is the safety alert symbol. It is used to alert you to potential personal injury hazards. Obey all safety messages that follow this symbol to avoid possible injury or death.

⚠ WARNING

This mark indicates procedures which, if improperly performed, might lead to the death or serious injury of the user.

⚠ CAUTION

This mark indicates procedures which, if improperly performed, might possibly result in personal harm to the user, or damage to property.

NOTICE

Notice is used to address practices not related to personal injury.

General Safety Precautions

1. Instructions for installation and use of this product are provided by the manufacturer. For proper operation, the system must be installed in accordance with this installation manual.
2. Installation must be performed in accordance with local laws, regulations and National Electrical Codes (NEC).
3. If refrigerant leaks while work is being carried out, ventilate the area. Do not allow refrigerant to come in contact with a flame as it produces toxic gas.
4. Disconnect all electrical power to the indoor and outdoor units until the system is ready for start-up and checkout.
5. When installing or repairing the system, use only R410A refrigerant. Do not mix refrigerant with other gases. If air or other gas enter the refrigeration system, the pressure inside the system may rise to an abnormally high value and cause damage or injury.

⚠ WARNING

This appliance is not intended for use by persons (including children) with reduced physical, sensory or mental capabilities, or lack of experience and knowledge, unless they have been given supervision or instruction concerning use of the appliance by a person responsible for their safety.

NOMENCLATURE

Indoor unit

Example: UMAT18HP230V1AC

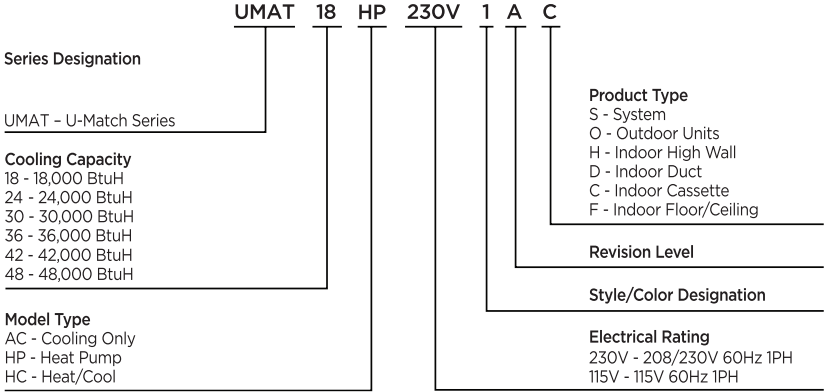

Outdoor unit

Example: UMAT18HP230V1AO

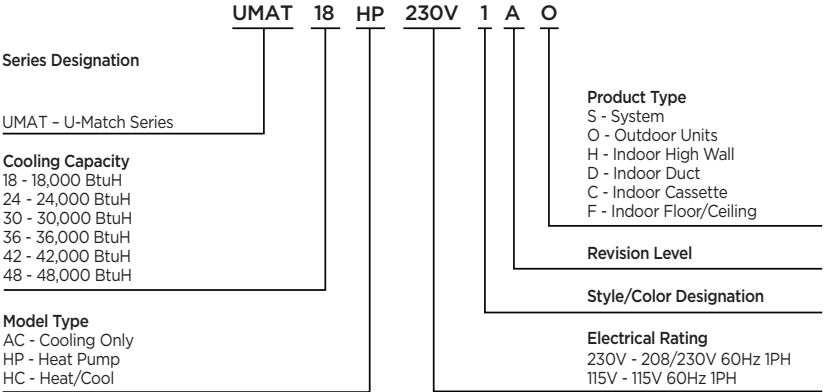

SYSTEM REQUIREMENTS

PIPE SIZE in (mm)

REFRIGERANT LINE LENGTHS ft (m)

Unit Size (BtuH)	Liquid Line	Suction/Gas Line	Min Line Length	Max. Pre-Charge Line Length	Max Line Length	Max Elevation (ID over OD)
18,000	1/4 (6)	1/2 (12)	10 (3)	25(7.5)	164 (50)	49 (15)
24,000	3/8 (10)	5/8 (15)	10 (3)	25(7.5)	164 (50)	49 (15)
30,000	3/8 (10)	5/8 (15)	10 (3)	25(7.5)	164 (50)	49 (15)
36,000	3/8 (10)	5/8 (15)	10 (3)	25(7.5)	164 (50)	49 (15)
42,000	3/8 (10)	5/8 (15)	10 (3)	25(7.5)	164 (50)	49 (15)
48,000	3/8 (10)	5/8 (15)	10 (3)	25(7.5)	230(70)	49 (15)

Notes: Insulate both refrigerant lines, separately.

REFRIGERANT CHARGE

Unit Size (BtuH)	Refrigerant Type	Factory System Charge oz (kg)*	Additional Charge oz/ft (g/m)
18,000	R410A	49.4 (1.4)	0.3 (30)
24,000	R410A	78.4 (2.2)	0.6 (60)
30,000	R410A	84.6 (2.4)	0.6 (60)
36,000	R410A	123.2 (3.6)	0.6 (60)
42,000	R410A	131.2 (3.8)	0.6 (60)
48,000	R410A	141.8 (4.1)	0.6 (60)

*Precharge amount for up to 25-ft of refrigerant pipe.

INDOOR UNIT ELECTRICAL REQUIREMENTS

Unit Size (BtuH)	Voltage	Min Circuit Amps (MCA)	Max Overcurrent Protection (MOCP)	Main Power Wire Size (AWG)
18,000	208/230v - 1ph 60hz	1.0	15	14
24,000	208/230v - 1ph 60hz	1.0	15	14
30,000	208/230v - 1ph 60hz	1.5	15	14
36,000	208/230v - 1ph 60hz	1.5	15	14
42,000	208/230v - 1ph 60hz	1.5	15	14
48,000	208/230v - 1ph 60hz	2.0	15	14

OUTDOOR UNIT ELECTRICAL REQUIREMENTS

Unit Size (BtuH)	Voltage	Min Circuit Amps (MCA)	Max Overcurrent Protection (MOCP)	Main Power Wire Size (AWG)
18,000	208/230v - 1ph 60hz	17.0	25	10
24,000	208/230v - 1ph 60hz	24.0	40	10
30,000	208/230v - 1ph 60hz	24.0	40	10
36,000	208/230v - 1ph 60hz	29.0	45	8
42,000	208/230v - 1ph 60hz	31.0	50	8
48,000	208/230v - 1ph 60hz	45.0	70	6

Communication Cable (Field Supplied): Recommended cable - 18/2 AWG stranded bare copper conductors THHN 300V unshielded wire Note: Use shielded cable if installation is in close proximity of RF and EMI transmitting devices.

SUGGESTED TOOLS



- *Standard Wrench*
- *Adjustable/Crescent Wrench*
- *Torque Wrench*
- *Hex Keys or Allen Wrenches*
- *Drill & Drill Bits*
- *Hole Saw*
- *Pipe Cutter*
- *Screw drivers (Phillips & Flat blade)*
- *Manifold and Gauges*
- *Level*
- *R410A Flaring Tool*
- *Clamp on Amp Meter*
- *Vacuum Pump*
- *Safety Glasses*
- *Work Gloves*
- *Refrigerant Scale*
- *Micron Gauge*



System Schematic

Indoor unit

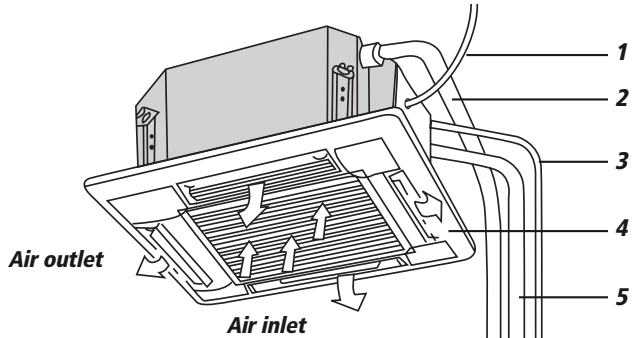

System Components*

1. Indoor Power Supply
2. Drain Pipe
3. Communication Cable
4. Decorative Discharge Air Grille (sold separately)
5. Refrigeration Pipes
6. XK60 Tether Controller (sold separately)
7. Remote Controller
8. Service Cover
9. Communication Cable
10. Front Panel
11. Outdoor Power Supply
12. Liquid Pipe
13. Gas Pipe
14. Drain Hose

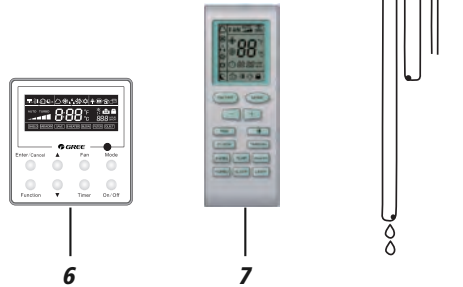

*Not all items included in equipment purchase

Outdoor Unit

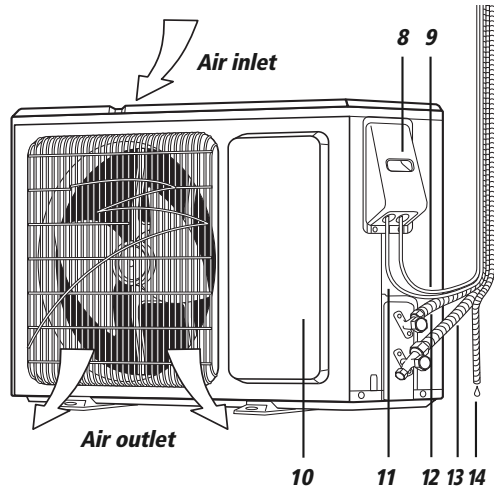













CAUTION



The refrigerant pipe, drain pipe and electrical wiring for this unit should be installed by a qualified HVAC professional only.

STANDARD PARTS

Indoor Unit Accessories

No.	Name	Appearance	Qty	Usage
1	Drain Hose		1	Connects with field supplied drain pipe
2	Screw with Washer		4	Secures the hook on the cabinet of the unit
3	Washer		10	Used together with the hanger bolt for installing the unit
4	Installation Template		1	Used for ceiling drilling
5	Gasket Mounting Board		4	Prevents gasket from falling off
6	Remote Controller		1	Remotely controls the indoor unit
7	Cable Clamp		4	Fastens the insulation to pipe
8	Pipe Insulation		1	Insulates the gas pipe
9	Pipe Insulation		1	Insulates the liquid pipe
10	Insulation		4	Insulates the drain pipe
11	Flare Nut		1	Connects the gas pipe
12	Flare Nut		1	Connects the liquid pipe
13	Service Valve Cap		2	Protects service port

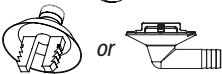
Outdoor Unit Accessories

No.	Name	Appearance	Qty	Usage
1	Drain Plug		2 or 3	Plugs the unused drain hole
2	Drainage Connector	 or 	1	Connects with the hard PVC drain pipe

INSTALLATION SITE INSTRUCTIONS

Indoor Unit

WARNING

The unit must be installed in a location which can withstand four times the weight of the unit. Inadequate support may result in serious property damage and injuries.

Select a site that allows for the following:

- Ensure the installation complies with the installation minimum dimensions and meets the minimum and maximum connecting piping length and maximum change in elevation.
- Air inlet and outlet should be clear of obstructions, ensuring proper airflow throughout the room.
- Condensate can be easily and safely drained.
- All connections can be easily made to outdoor unit.
- Indoor unit is out of reach of children.
- A structure strong enough to withstand four (4) times the full weight and vibration of the unit.
- Filter can be easily accessed for cleaning.
- Leave enough free space to allow access for routine maintenance.
- Do not install in a laundry room or by a swimming pool due to chemicals corroding cassette coil.

Minimum Indoor Clearances

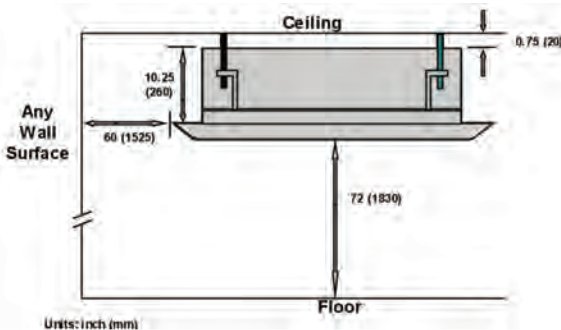

INSTALLATION SITE INSTRUCTIONS

Outdoor Unit

Select a site that allows the following:

WARNING

The unit should be installed level on a pad that can support twice the weight of the unit. If the outdoor unit will be exposed to strong winds, it must be adequately secured.

CAUTION

Do not install the unit at a location where the distance exceeds the maximum pipe length indicated in the table. The maximum length of the connection pipe is listed in the System Requirements section.

1. Install the outdoor unit at a location that is capable of withstanding twice the weight of the unit.
2. Install the outdoor unit where it is convenient to connect refrigerant lines to the indoor unit.
3. Install the outdoor unit where the condensate water can be drained unobstructed during the heating mode to a safe location.
4. Do not locate the unit where the noise may be objectionable to neighbors.
5. Provide the space shown below, so that the air flow is not blocked and future service and maintenance can be performed.

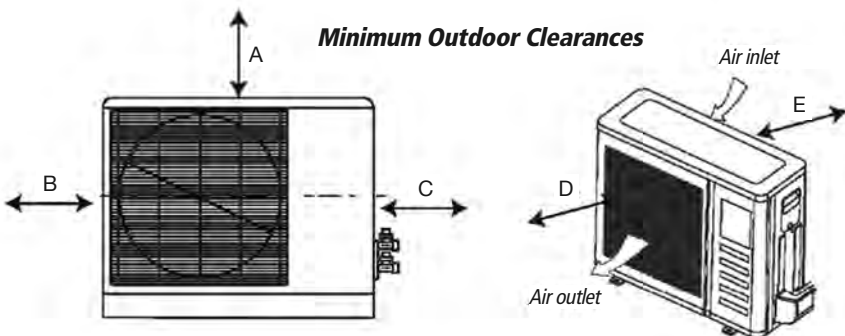

Outdoor Unit	Minimum Distances in (mm)
A	40 (1000)
B	20 (500)
C	20 (500)
D	78(1980)
E	20 (500)

INDOOR UNIT DIMENSIONS

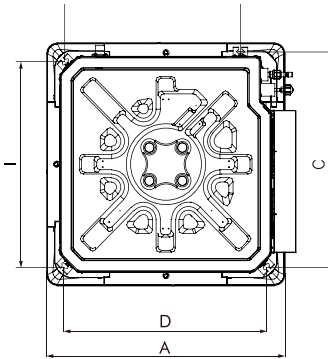

18K Indoor Unit Dimensions

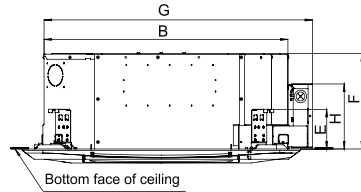

INDOOR UNIT DIMENSIONS in (mm)

Model	A	B	C	D	E	F	G	H	I	J
UMAT18HP230V1AC	26-3/8 (670)	23-1/2 (597)	23-1/4 (591)	22-5/8 (575)	5-3/4 (146)	9-1/2 (241)	26-1/8 (664)	9-1/4 (235)	22-5/8 (575)	19-7/8 (505)

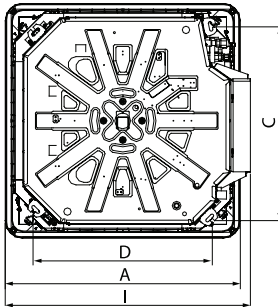

24K-42K Indoor Unit Dimensions

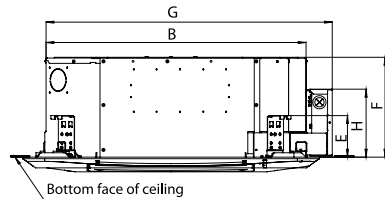

INDOOR UNIT DIMENSIONS in (mm)

Model	A	B	C	D	E	F	G	H	I
UMAT24HP230V1AC	37-3/8 (949)	32-3/4 (832)	30-3/4 (781)	26-3/4 (679)	6-1/4 (159)	9-1/2 (241)	36-1/8 (918)	8-1/2 (216)	39-1/8 (994)
UMAT30HP230V1AC	37-3/8 (949)	32-3/4 (832)	30-3/4 (781)	26-3/4 (679)	6-1/4 (159)	9-1/2 (241)	36-1/8 (918)	8-1/2 (216)	39-1/8 (994)
UMAT36HP230V1AC	37-3/8 (949)	32-3/4 (832)	30-3/4 (781)	26-3/4 (679)	6-1/4 (159)	9-1/2 (241)	36-1/8 (918)	8-1/2 (216)	39-1/8 (994)
UMAT42HP230V1AC	37-3/8 (949)	32-3/4 (832)	30-3/4 (781)	26-3/4 (679)	6-1/4 (159)	9-1/2 (241)	36-1/8 (918)	8-1/2 (216)	39-1/8 (994)

INDOOR UNIT DIMENSIONS

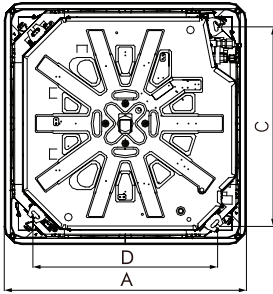

48K Indoor Unit Dimensions

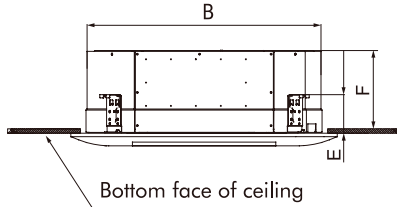

INDOOR UNIT DIMENSIONS in (mm)

Model	A	B	C	D	E	F
UMAT48HP230V1AC	41 (1041)	35-7/8 (911)	33-1/8 (841)	31 (787)	6-3/4 (171)	11-3/8 (289)

Laying Out Indoor Location

- Locate the factory supplied installation template included in carton.
- Use the template to make an opening in the ceiling for the ceiling cassette main body.
- Mark the position of the 4 hanger bolts, refrigerant lines and condensate drain pipes.

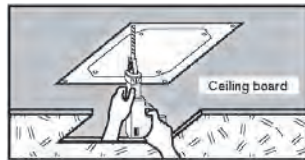
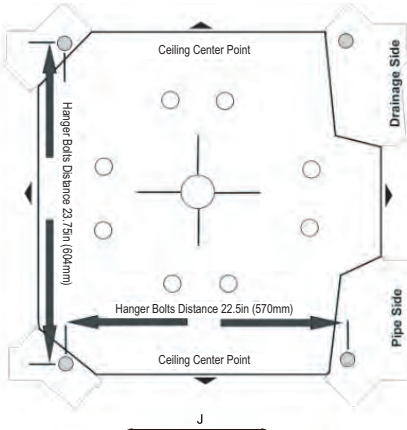

INDOOR UNIT INSTALLATION

Indoor Unit Hanger Mounting

Depending on the type of ceiling, attach the threaded hanger bolts securely to the support stud. Before lifting the indoor unit to the installation location, insert the upper nuts, flat washers (with insulation), flat washers (without insulation), lower nuts and double locking nuts on the threaded hanger bolts.

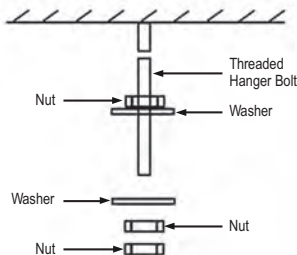

NOTE: The hanger bolts, nuts, and washers are field supplied. Install the washer with cushion so that the insulation faces downward.

Installation of Ceiling Cassette

Lift the Ceiling Cassette main body to the threaded hanger bolts. Insert the unit mounting brackets between washers and then fasten it securely.

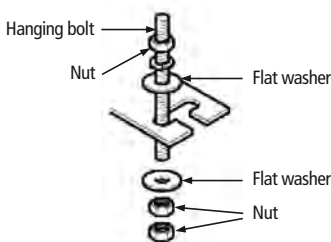

Confirm the position of the Indoor Unit:

1. Adjust the height of the Indoor Unit main body to align with false ceiling. Be sure to confirm this, otherwise condensation may form during cooling mode. Adjust mounting nuts as needed.
2. Confirm that the indoor unit main body is level. Adjust mounting nuts as needed.
3. After checking the positioning of the indoor unit main body, tighten the nuts of the hanger bolts securely to fasten the Indoor Unit main body in place.

OUTDOOR UNIT INSTALLATION

WARNING

The unit should be located with the unit support feet firmly on the equipment pad. If the outdoor unit is exposed to wind, it must be properly secured.

18K-36K

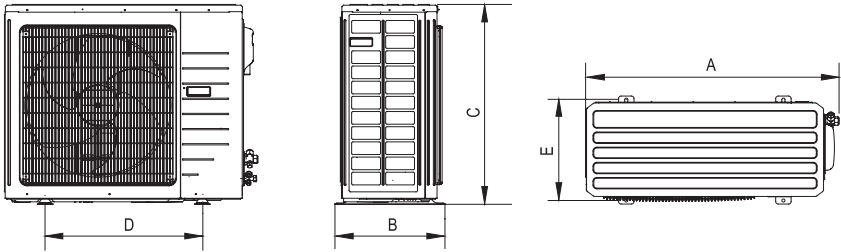

42K-48K

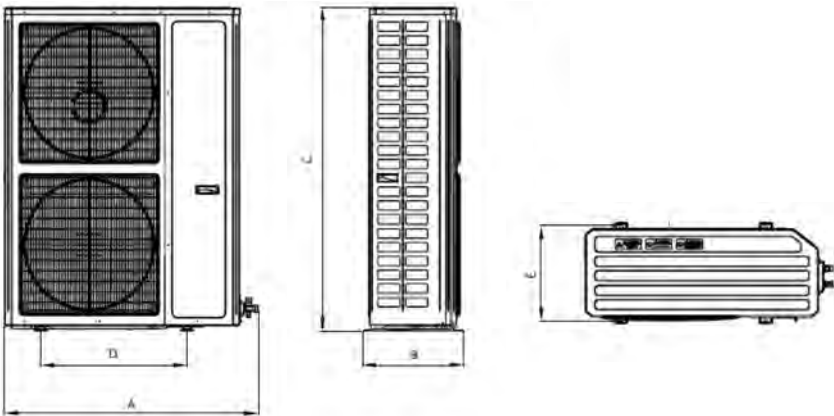

OUTDOOR UNIT DIMENSIONS in (mm)

Model	A	B	C	D	E
UMAT18HP230V1AO	37-5/8 (955)	15-5/8 (396)	27-1/2 (700)	22 (560)	14-1/8 (360)
UMAT24HP230V1AO	38-5/8 (980)	16-3/4 (427)	31-1/8 (790)	24 (610)	15-1/2 (395)
UMAT30HP230V1AO	43-5/8 (1107)	17-3/8 (440)	43-1/4 (1100)	24-7/8 (631)	15-3/4 (400)
UMAT42HP230V1AO	37-3/4 (958)	16-1/4 (412)	53-1/8 (1349)	22-1/2 (572)	14-3/4 (376)

OUTDOOR UNIT INSTALLATION

Condensate Drainage of the Outdoor Unit

The outdoor unit should be installed with a drain pipe to drain condensate water during the heating mode.

1. Insert the drain joint (included) into the selected hole located on the bottom of the base pan and then connect the drain hose (field supplied) to the drain joint.
2. All other holes must be sealed with plugs (included) to avoid water leaks, except for the drain pipe mounting hole.
3. Route drain hose to safe location for disposing of condensate water.

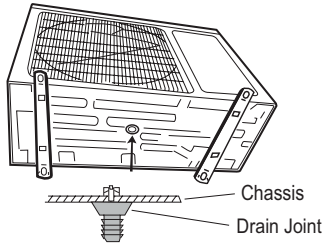
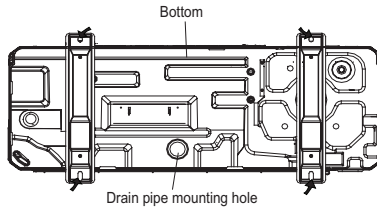

PIPING INSTALLATION

Refrigerant Piping

Drill Hole in Wall

1. Locate and mark proper location for the wall hole.
2. Cut the 2 3/4" wall hole with a 5° to 10° downward slant to the outdoors.
3. Insert a wall sleeve (field supplied) into hole to prevent damage to refrigerant pipes, insulation, condensate drain hose and wiring.
4. Proper weather proofing of the wall surface and wall sleeve is essential to assure a trouble-free installation. Apply sealant, caulking or equivalent weather proofing material around the perimeter of the wall sleeve (interior & exterior) to eliminate outdoor air and water leaks into the indoor space.

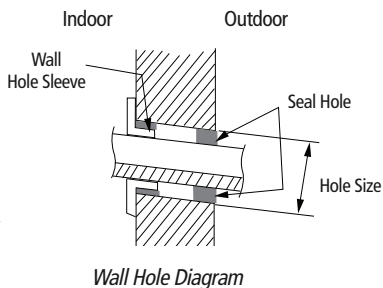

NOTE: Expandable foam insulation may be added to fill large wall gaps. Apply per manufacturer's instructions.

Piping Preparation

1. Do not open service valves or remove protective caps on pipes until instructed by this manual.
2. Keep tubing free of dirt, sand, moisture and contaminants.
3. Insulate each refrigerant pipe and condensate hose with minimum 3/8" (10 mm) wall thermal pipe insulation.

CAUTION

Insulate entire interior section of condensate hose to prevent sweating which may cause water stains or wall damage.

4. Bind refrigerant pipes and communication cable together with cable ties at 12-inch intervals.
5. Include the condensate hose in bundle for exterior portion only.

Indoor Unit below Outdoor Unit Application

When height difference between indoor unit and outdoor unit is more than 30 feet, an oil return bend should be added for every 20 feet of connection pipe as shown.

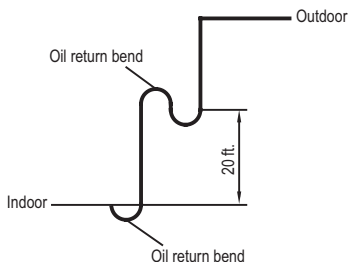

PIPING INSTALLATION

Indoor Unit Pipe Connections

1. Feed refrigerant pipes, drain hose and communication cable assembly through wall hole from outdoor to the Ceiling Cassette.
2. Pull the piping assembly to the indoor unit. Carefully bend refrigerant pipes to meet indoor unit connection ports. Use proper tools to avoid kinks.
3. Add a small amount of refrigerant oil to both ends of the flare fittings.
4. Starting with either refrigerant pipe, carefully center the pipe to the indoor unit connection port then hand tighten the flare nut.
5. Repeat procedure with remaining pipe.
6. Tighten both flare nuts using a standard wrench and a torque wrench as shown below.

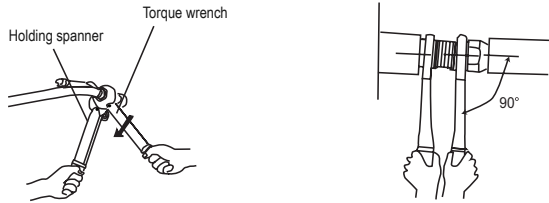
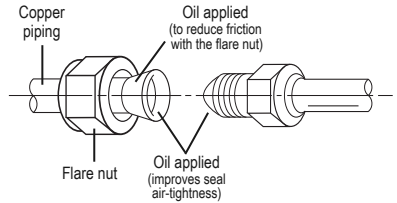

7. Carefully tighten flare nuts to correct torque level referring to the Torque Table below.

Pipe Diameter inch (mm)	Nut Size inch (mm)	Tightening Torque	
		ft-lbs	N-m
1/4 (6.35)	1/4 (17)	10 to 13	14 to 18
3/8 (9.5)	3/8 (22)	25 to 30	34 to 42
1/2 (12.7)	1/2 (25)	36 to 45	49 to 61
5/8 (15.9)	5/8 (29)	50 to 60	68 to 82

CAUTION

Over tightening may damage flare connections and cause leaks.

8. Individually insulate each bare refrigerant pipe and joint as shown below to prevent sweating.

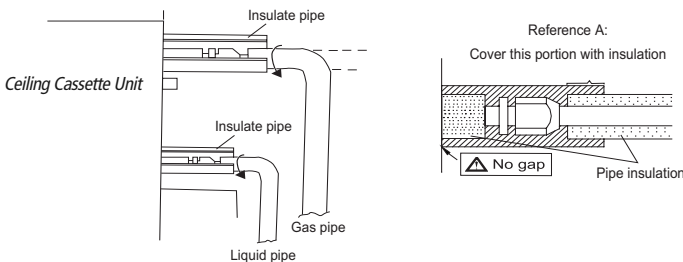

PIPING INSTALLATION

Outdoor Unit Pipe Connections

1. Remove service valve cover (if provided) to access the service valves and refrigerant ports.
2. Carefully bend and adjust length of refrigerant pipes to meet outdoor unit service valve connections with proper tools to avoid kinks.

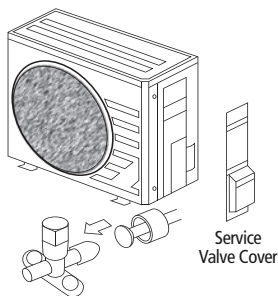

3. Add a small amount of refrigerant oil to both ends of the flare fittings.

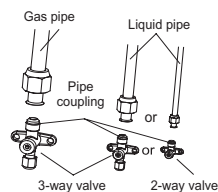

4. Starting with either refrigerant pipe, carefully center the pipe to the indoor unit connection port then hand tighten the flare nut.

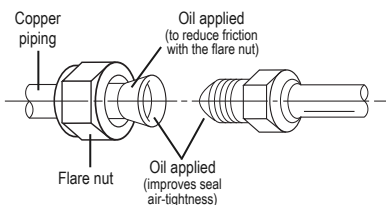

5. Repeat procedure with remaining pipe.

6. Tighten both flare nuts using a standard wrench and a torque wrench as shown.

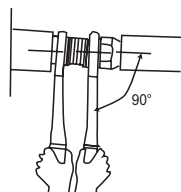

7. Carefully tighten flare nuts to correct torque level referring to the Torque Table below.

Pipe Diameter inch (mm)	Nut Size inch (mm)	Tightening Torque	
		ft-lbs	N-m
1/4 (6.35)	1/4 (17)	10 to 13	14 to 18
3/8 (9.5)	3/8 (22)	25 to 30	34 to 42
1/2 (12.7)	1/2 (25)	36 to 45	49 to 61
5/8 (15.9)	5/8 (29)	50 to 60	68 to 82

CAUTION

Over tightening may damage flare connections and cause leaks.

PIPING INSTALLATION

Indoor Condensate Drain Piping

WARNING

Observe all local sanitary codes when installing condensate drains.

It is recommended to install the condensate drain system with hard polyvinyl chloride (PVC) pipe and matching connectors. Use piping of the same diameter as the unit connection, or of the same diameter of the raising section.

The Ceiling Cassette drainage port diameter is 1-in (25 mm) OD.

Pitch the condensate drain pipe at a gradual 2.5% pitch (Example: ¼-in drop over a 10-in length) without obstructions. Use pipe hanger/brackets to support the condensate drain pipe from dropping.

NOTE: Insulate condensate hose and/or pipes to prevent sweating which may cause water stains or wall damage.

Typical Drainage System

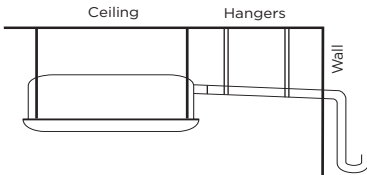

Vertical Lift Drainage System

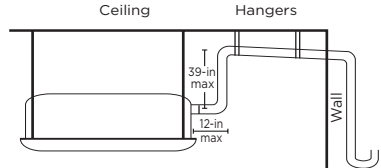

If a gradual pitch from the drainage port is not obtainable, the Ceiling Cassette contains an internal condensate drain pump with limited head or lift. The condensate drain pipe may have a vertical height of 39-in. maximum above the unit drainage port within the first 12-in as long as the remaining condensate drain pipe gradually descends from that point and is aligned with drainage port.

Use an auxiliary condensate pump with float valve for vertical height greater than 39-in. above the unit drainage port. A float valve is recommended to shut off the system if the auxiliary pump fails.

Completing Condensate Drainage Piping

- Include the exterior section of condensate hose in the pipe/wire bundle.
- Fasten the refrigerant and condensate pipe assembly to the exterior wall for support.
- The drain pipe should terminate 6 inches above grade.

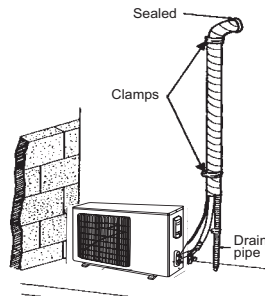

POWER AND WIRING INSTALLATION

WARNING

1. *Before obtaining access to terminals, all electrical supply circuits must be disconnected.*
2. *Always use an independent circuit and provide an independent circuit breaker to supply power to the system.*
3. *Use a circuit breaker with adequate capacity to meet the requirements of the total system.*
4. *All circuit breakers or fuses for the indoor and outdoor units should be installed per the National Electric Code (NEC) and local regulations.*
5. *Electrical wiring must be completed in accordance with NEC, local laws, and regulations of the electric company so that the system will operate properly.*
6. *Provide a GFI circuit breaker at the electrical panel in accordance with the NEC and the local electrical company standards.*
7. *Connect the power supply firmly to the terminal block. Improper installation may cause a fire.*

CAUTION

1. *The main power supplies are high-voltage, while the communication wire and the Tether Controller are low-voltage. They should be installed separately to avoid electromagnetic interference.*
2. *High-voltage and low-voltage lines should pass through separate rubber rings at electric box covers.*
3. *If the indoor unit communication wire (to the outdoor unit) and power wire are connected incorrectly, the air conditioner may be damaged.*
4. *Ground both indoor unit and outdoor unit to earth ground in accordance with the applicable local and national codes.*

POWER AND WIRING INSTALLATION

Electric Wiring Between Indoor Unit and Outdoor Unit

Typical Wiring Diagram

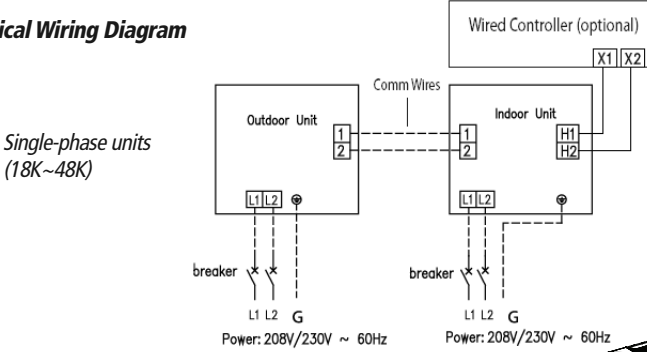

Indoor Unit Electrical Wiring

Locate and remove the electrical box cover to access wire terminals.

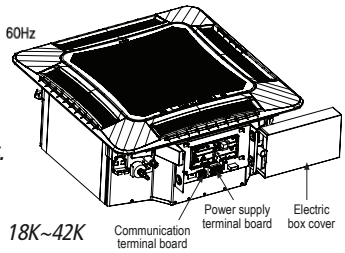

Indoor Communication Wiring

The recommended communication cable size is a minimum 18/2 AWG stranded bare copper conductors THHN 300V unshielded wire. Use shielded cable if installation is in close proximity of RF and EMI transmitting devices. Locate wire terminals #1 and #2. Connect communication cable from outdoor unit to terminals #1 and #2. Secure cable inside wire clamp/strain relief. Verify cable is secure, not loose and no external force on wires affects the connections at the terminals.

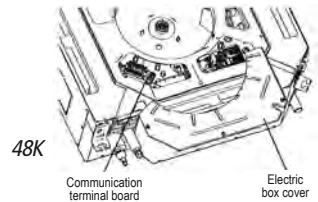

NOTE: Record wire colors and terminal references for use with Outdoor Unit wire connections.

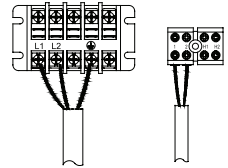

Indoor Unit Power Wiring

Locate wire terminals L1 and L2. Connect main electrical power outdoor unit to terminals L1 and L2. Connect ground wire to grounding screw. Secure electrical wires inside wire clamp/strain relief. Verify wires are secure, not loose and no external force on wires affects the connections at the terminals.

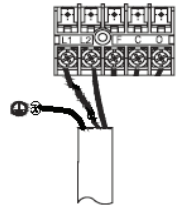

POWER AND WIRING INSTALLATION

Tether Controller Wiring (optional)

Use a minimum 18-2 AWG wire (field supplied) to connect Tether Controller to the indoor unit. Route wire from Tether Controller into electrical box. Locate wire terminals H1 and H2. Connect Tether Controller wires to H1 and H2. Verify wires are secure, not loose and no external force on wires affects the connections at the terminals. Replace and Secure indoor unit electric box cover.

Outdoor Unit Electrical Wiring

Remove the large handle access plate on the 18K to 30K size or the front panel for the 36K to 48K size to access wire terminals.

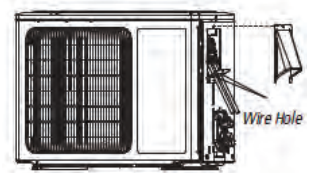

Outdoor Communication Wiring

Connect communication cable from indoor unit to terminals #1 and #2. Maintain the same wire colors and terminal references as indoor unit wire connections.

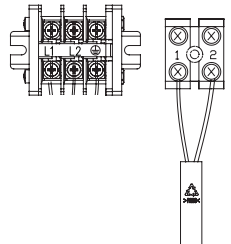

NOTE: Crossing communication wires will cause an E6 system malfunction code and possible damage.

Secure cable inside wire clamp/strain relief. Verify cable is secure, not loose and no external force on wires affects the connections at the terminals.

Outdoor Unit Power Wiring

Insert main power wires through the wire holes on conduit mounting bracket. Secure main electrical power conduit with locking nuts to conduit mounting bracket. Locate wire terminals L1 and L2. Adjust wire lengths for proper connections to the outdoor unit terminal block. Connect main electrical power outdoor unit to terminals L1 and L2. Connect Ground wire to ground terminal/screw. Secure electrical wires inside wire clamp/strain relief. Verify wires are secure, not loose and no external force on wires affects the connections at the terminals. Replace and secure electrical box cover to outdoor unit.

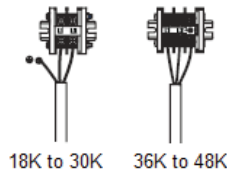

NOTE: When connecting the power wire, make sure that the phase of the power supply matches with the exact terminal board. If not, the compressor will rotate reversely and run improperly.

CONTROLLER INSTALLATION AND SETUP (Optional)

The following is a brief overview of the Wired Tether Controller installation. See Owner's Manual for more detailed instructions for setup and operation.

Preparation for Installation

Select a proper location on the wall for mounting the Tether Controller. Install switch box, if required by code. The maximum wire length between indoor and Tether Controller is 30-ft. Run communication cable (as desired) between indoor unit and selected wall mounting location. See Indoor Unit wiring section for instruction to connect the Wired Tether Controller to the indoor unit.

Wired Tether Controller Installation

Pull communication cable through switch box (if one is used) and Wired Tether Controller backplate. Securely fasten backplate to the switch box or wall.

Locate wire terminals X1 and X2 on rear of Tether Controller panel. Carefully connect wire X1 to indoor unit terminal H1 and X2 to indoor unit terminal H2. Verify wires are secure, not loose and no external force on wires affects the connections at the terminals. Push extra cable into wall and secure controller panel to backplate mounted on the wall.

NOTE: Do not cut or splice communication cable.

Follow the instructions supplied with the Owner's Manual for setup and operation.

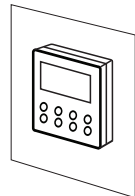
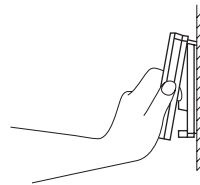
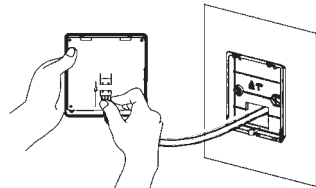
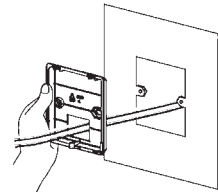

CONTROLLER INSTALLATION AND SETUP (Optional)

Setting Double Indoor Room Sensors

This series of Ceiling Cassette has two indoor room sensors, if an optional wired Tether Controller is installed. One is located at the air intake of the Ceiling Cassette and the other is located inside the Tether Controller. The user can select one from the two indoor room sensors on the basis of their own preference. Refer to the I-FEEL Function in the Tether Controller Owner's Manual for detailed instructions.

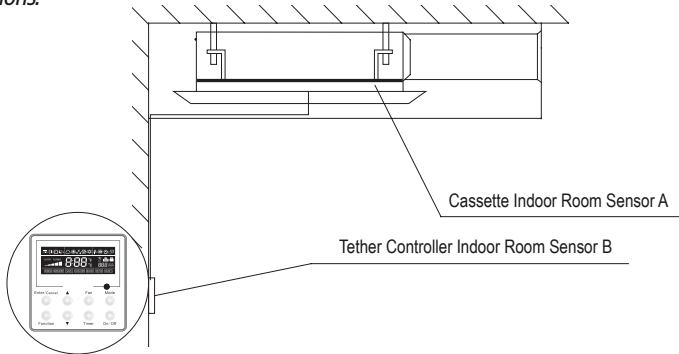

CEILING CASSETTE PANEL DISPLAY

Power ON/OFF Indicator:

Red when the unit is powered on, white when the unit has started.

Timer Indicator:

Yellow when the time is set, off when it is not.

Digital Display:

When it receives a valid signal from the remote controller, it will display the room set temperature for 5 seconds. When there is a malfunction, it will display the error code.

Auto Button:

The system will automatically select heating or cooling to maintain room temperature within 68° F to 78° F cooling. Setpoint band is not adjustable.

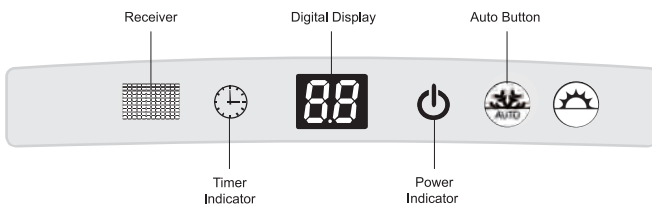

FRESH AIR INTAKE

Connecting Fresh Air Duct

The indoor ceiling cassettes have a fresh air intake port for ventilation. A booster fan and duct (field supplied) must be used to feed outdoor air to the indoor unit.

Determine the duct diameter, length and booster fan size based on the required airflow. See table below for duct and hole sizes:

Unit Size (BtuH)	Hole Diameter inch (mm)	Min. Duct Diameter
18,000	2.375 (60)	2.5 (64)
24,000-48,000	2.875 (73)	3.0 (76)

NOTE: Fresh air intake amount should be 20% or less of whole air amount to prevent condensation.

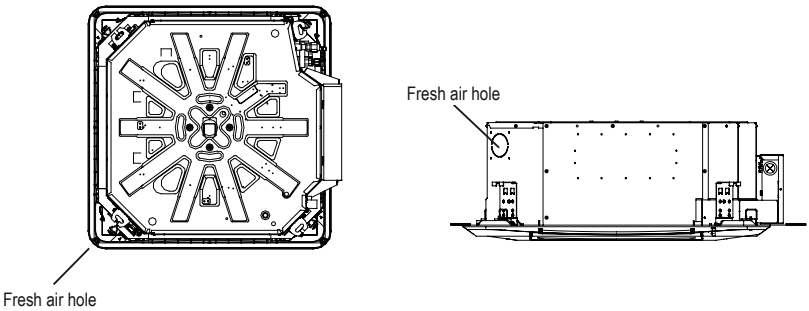

To install fresh air intake:

- Locate the fresh air hole on side of cassette unit
- Carefully remove knockout to open fresh air hole
- Cut a round hole through insulated wall
- Using a duct collar, attach fresh air duct to cassette

DECORATIVE GRILLE INSTALLATION

Mounting Decorative Grille

1. Carefully unpack decorative grille and align the decorative grille to the Ceiling Cassette main body.
2. Temporarily attach the decorative grille to the ceiling cassette main body at two (2) corner points.
3. Locate the two (2) Swing Louver electrical connectors on the decorative grille.
4. Connect both Swing Louver connectors on decorative grille to matching connectors on the Ceiling Cassette body.
5. Complete the decorative grille attachment by hooking the remaining two (2) corners to the Ceiling Cassette main body.

Note: Be careful not to pinch the swing louver motor wires between the decorative grille and ceiling cassette main body.

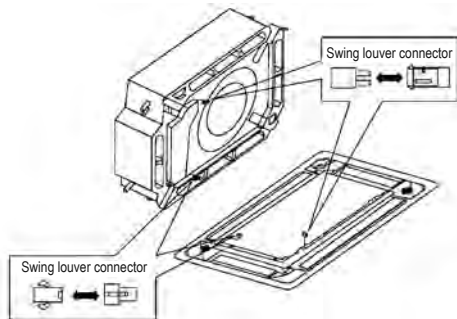
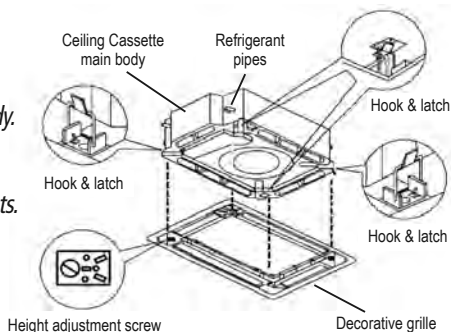

6. Find the four (4) height adjustment screws located on the corners of the decorative grille. Use the four (4) height adjustment screws to adjust gap between decorative grille and Ceiling Cassette body so that gap is reduced to 1/4-in (6mm) to 3/8-in (9mm). Make certain the decorative grille is not distorted by over tightening.
7. Verify that the seal between decorative grille and Ceiling Cassette main body is tight all the way around the unit to prevent air leakage. Use the height adjustment screws to adjust the gap.

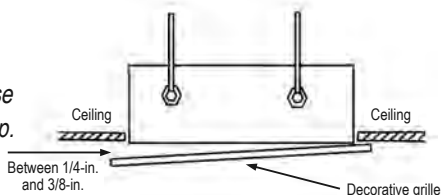

TESTING AND INSPECTION

Pipe Testing

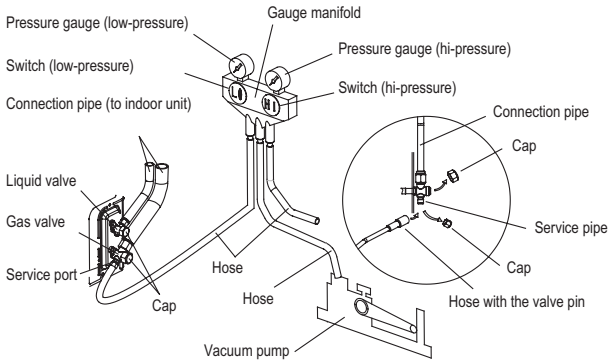

Leak Test

Refrigerant lines should be pressurized prior to evacuating system to check for leaks. Use only dry nitrogen with a pressure regulator for pressurizing unit. Pressurize with 150 psi of dry nitrogen. Apply soap and water to check whether the joints are leaky. A leak detector may also be used for a leakage test.

NOTE: You may want to perform leak testing and evacuation before wiring to save time, electrical connections can be completed while your vacuum pump is running.

CAUTION

Use vacuum pump, rather than refrigerant, to discharge air when installing the unit.

Additional Charge

Refrigerant for the pipe length of 25 feet has been charged at the factory. If the piping is greater than 25 feet additional charging is necessary. For the additional amount, see the table below.

Model	Add'l Refrigerant (oz/ft (g/m))
18,000	0.3 (30)
24,000	0.6 (60)
30,000	0.6 (60)
36,000	0.6 (60)
42,000	0.6 (60)
48,000	0.6 (60)

TESTING AND INSPECTION

Vacuum Procedure

Important: Use a quality Micron Gauge to measure and validate the proper system vacuum level achieved. Do not rely on the scale of a "bourbon tube" type gauge set to validate the depth and quality of the vacuum.

1. Remove the caps of the liquid valve, gas valve and service port.
2. Connect gauge manifold and micron gauge to the service ports provided at the liquid and suction service valves.
3. Connect a vacuum pump to the manifold gauge.
4. Open the lower pressure side of the manifold valve assembly and start the vacuum pump. The switch at the high pressure side of the manifold valve assembly should be kept closed, or evacuation does not fail.
5. Operate vacuum pump until a vacuum of 500 microns or less is achieved. The evacuation duration depends on the vacuum pump size and unit's capacity, generally 20 minutes for the 9,000 BtuH units, to 1 hour for a larger 36,000 BtuH unit.
6. Close the manifold valves and shut off the pump.
 - a. If vacuum holds below 700 microns for 15 minutes, the system can be considered dry and leak free. Go to step 5.
 - b. If vacuum increases to 800 microns or greater, this is an indication of moisture in system or a leak exists. Identify leak and repair as necessary, after which repeat steps 4 and 5. If moisture is suspect, purge system use triple evacuation method using dry nitrogen.
7. Confirm that manifold valves are closed and disconnect the vacuum pump.
8. Open the service valves to the fully 'back-seat' position to let the refrigerant flow to the indoor unit and balance the pressure in system.

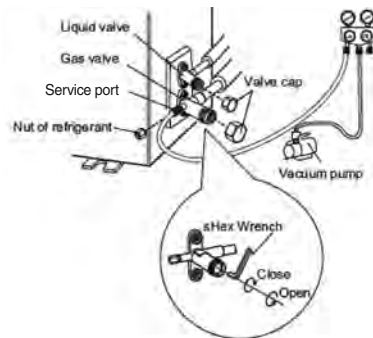

Note: Do not allow air to enter the connection pipe when removing the hose.

9. Replace service valve caps and tighten.

TESTING AND INSPECTION

Start-up Checklist

- **Turn on main power to indoor and outdoor units.**
 - Verify the system is not displaying an error code on the indoor unit display.
- **Point the Remote Controller at the Floor/Ceiling unit and Press the On button.**
 - Verify the remote controller display turns ON and the Power Indicator lights up on the Floor/Ceiling unit.
- **Press the Mode button to Cooling.**

Adjust the room setpoint to bring the system on in cooling mode. The system should start cooling mode within 3-5 minutes.

 - Verify the setpoint lights up on the Floor/Ceiling unit display.
 - Verify the outdoor fan and compressor are operating.
 - Verify the indoor fan is operating.
 - Verify the indoor discharge air is cooling the room.
- **Press the Mode button to Heating.**

Adjust the room setpoint to bring the system on in heating mode. The system should start heating mode within 3-5 minutes.

 - Verify the new setpoint lights up on the Floor/Ceiling unit display.
 - Verify the outdoor fan and compressor are operating.
 - Verify the indoor fan is operating.
 - Verify the indoor discharge air is heating the room.
- **Press the OFF button on the Remote Controller.**
 - Verify Remote Controller display turns OFF and the system shuts OFF.

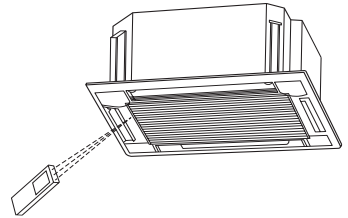

- **Test the Drain Piping.**

The Ceiling Cassette contains a condensate pump and float switch. Test the condensate disposal system by the following:

1. Remove grille and frame from the unit and find the drainage port.
2. Locate and Remove the access cover.
3. Place the unit in cooling mode and wait until the compressor turns on.
4. Slowly add 20 to 24 oz. of a water bottle to the drain pan.
5. Water must drain freely from the unit with condensate pump energized. If not, check the pipe slope or see if there are any pipe restrictions. Verify all piping joints are leak free.

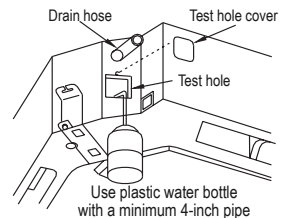

Note: This unit is equipped with a safety float switch to de-energize the compressor if the water level gets too high.

TROUBLESHOOTING

PROBLEM	CAUSE/SOLUTION
System does not restart.	<p>Cause: The system has a built-in three-minute delay to prevent short and/or rapid cycling of the compressor.</p> <p>Solution: Wait three minutes for the protection delay to expire.</p>
Indoor unit emits unpleasant odor when started	<p>Cause: Typically unpleasant odors are the result of mold or mildew forming on the coil surfaces or the air filter.</p> <p>Solution: Wash indoor air filter in warm water with mild cleaner. If odors persist, contact a qualified service professional to clean the coil surfaces.</p>
You hear a “water flowing” sound.	<p>Cause: It is normal for the system to make “water flowing” or “gurgling” sounds from refrigerant pressures equalizing when the compressor starts and stops</p> <p>Solution: The noises should discontinue as the refrigerant system equalizes after two or three minutes.</p>
A thin fog or vapor coming out of the discharge register when system is running.	<p>Cause: It is normal for the system to emit a slight fog or water vapor when cooling extremely humid warm air.</p> <p>Solution: The fog or water vapor will disappear as the system cools and dehumidifies the room space.</p>
You hear a slight cracking sound when the system stops or starts.	<p>Cause: It is normal for the system to make “slight cracking” sounds from parts expanding and contracting during system starts and stops.</p> <p>Solution: The noises will discontinue as temperature equalizes after 2 or 3 minutes.</p>
The system will not run.	<p>Cause: There are a number of situations that will prevent the system from running.</p> <p>Solution: Check for the following:</p> <ul style="list-style-type: none"> • Circuit breaker is “tripped” or “turned off.” • Power button of controller is not turned on. • Controller is in sleep mode or timer mode. • Otherwise, contact a qualified service professional for assistance.
The unit is not heating or cooling adequately.	<p>Cause: There are a number of reasons for inadequate cooling or heating.</p> <p>Solution: Check the following:</p> <ul style="list-style-type: none"> • Remove obstructions blocking airflow into the room. • Clean dirty or blocked air filter that is restricting airflow into the system. • Seal around door or windows to prevent air infiltration into the room. • Relocate or remove heat sources from the room.

TROUBLESHOOTING

PROBLEM	CAUSE/SOLUTION
<p>Water leakage from the outdoor unit.</p>	<p>Cause: It is normal for the outdoor unit to generate condensate water in the reverse cycle heating and defrost mode.</p> <p>Solution: This is normal. No action is required.</p>
<p>Water leaking from the indoor unit into the room.</p>	<p>Cause: While it is normal for the system to generate condensate water in cooling mode, it is designed to drain this water via a condensate drain system to a safe location.</p> <p>Solution: If water is leaking into the room, it may indicate one of the following.</p> <ul style="list-style-type: none"> • The indoor unit is not level right to left. Level indoor unit. • The condensate drain pipe is restricted or plugged. All restrictions must be removed to allow continuous drainage by gravity. • If problem persists, contact a qualified service professional for assistance.
<p>The unit will not deliver air.</p>	<p>Cause: There are a number of system functions that will prevent air flow.</p> <p>Solution: Check for the following:</p> <ul style="list-style-type: none"> • In heating mode, the indoor fan may not start for three minutes if the room temperature is very low. This is to prevent blowing cold air. • In heat mode, if the outdoor temperature is low and humidity is high, the system may need to defrost for up to 10 minutes before beginning a heating cycle. • In dry mode, the indoor fan may stop for up to three minutes during the compressor off delay. • Otherwise, you should contact a qualified service professional for assistance.

DIAGNOSTIC CODES

The U-Match System has on board diagnostics. The indoor unit and Tether Controller will display error codes. The following is a summary of the codes with explanation:

Error Codes

No.	Error Code	Malfunction Name	Origin of Malfunction	Description
1	E1	High Pressure Protection	High Pressure Switch	If outdoor unit detects the high pressure switch is cut off for 3-sec successively, high pressure protection will occur. All the loads (except the 4-way valve in heating mode) will be switched off. In this case, all the buttons and remote control signals except ON/OFF button will be disabled and system won't be recovered automatically. Switch off the unit or re-energize the unit after cutting off power to eliminate this protection.
2	E2	Indoor Coil Freeze Protection	Indoor Evaporator Temperature Sensor	If indoor unit detects the evaporator temperature is lower than protective temperature value after the unit has been running for a period of time under cooling or dry mode, the unit will report this fault, in which case the compressor and outdoor fan motor will be stopped. The unit will not run until evaporator temperature is higher than the protective temp. value and the compressor is stopped for 3-min.
3	E3	Low Pressure Protection	Low Pressure Switch	If outdoor unit detects low-pressure switch is open during ON or standby state within 30-sec successively the unit will report a low pressure protection. If the fault occurs 3 times successively within 30-min, the unit will not recover automatically.
		Low Refrigerant Protection		If the unit reports low refrigerant level within 10-min after turning on the unit, the unit will stop operation. If the fault occurs successively 3 times, the unit cannot be recovered automatically.
		Refrigerant Recycling Mode		If the unit enters refrigerant recovery mode through special operation, E3 will be displayed. After exiting refrigerant recovery mode, the code will disappear.
4	E4	Compressor High Discharge Temperature Protection	Compressor Discharge Temperature	If outdoor unit detects the discharge temperature is higher than protective temperature value, the unit will report high discharge temperature protection. If the protection occurs over 6 times, the unit cannot be recovered automatically. Switch off the unit or re-energize the unit after cutting off power to reset this protection.
5	E6	Communication Malfunction	Communication Failure Between Indoor and Outdoor Main Board	If the outdoor unit does not receive data from indoor unit, communication malfunction will be reported. If there is communication abnormality between display board and indoor unit, communication malfunction will be reported.
6	E8		Indoor Fan Motor	If the indoor unit does not receive signal from indoor fan motor for 30-sec successively when the fan motor is operating, indoor fan motor malfunction will be reported. In this case, the unit can automatically resume operation after stopping. If the malfunction occurs 6 times within one hour, the unit cannot be recovered automatically. Switch off the unit or re-energize the unit after cutting off power to eliminate this malfunction.

DIAGNOSTIC CODES

Error Codes

No.	Error Code	Malfunction Name	Origin of Malfunction	Description
7	E9	Condensate Overflow Protection	Overflow Switch	If indoor unit detects the condensate overflow switch warning for 8-sec successively, the system will enter condensate overflow protection. The unit will shut off and will not recover automatically. Switch unit off and then switch it on to eliminate this malfunction.
8	F0	Indoor Ambient Temperature Sensor at Return Air Inlet Malfunction	Indoor Ambient Temperature Sensor	If indoor unit detects the indoor ambient temperature sensor is open circuit or short circuit for 5-sec successively, indoor ambient temp. sensor malfunction will be reported. The unit can automatically resume operation after the malfunction disappears. If indoor ambient temperature sensor malfunction occurs in fan mode, only the error code is displayed and the indoor unit will operate normally.
9	F1	Indoor Evaporator Coil Temperature Sensor Malfunction	Evaporator Coil Temperature Sensor	If indoor unit detects the evaporator temperature sensor is open circuit or short circuit for 5-sec successively, evaporator temperature sensor malfunction will be reported. The unit can automatically resume operation after the malfunction disappears. If evaporator temperature sensor malfunction occurs in fan mode, only the error code is displayed and the indoor unit will operate normally.
10	F2	Indoor Condenser Coil Temperature Sensor Malfunction	Condenser Coil Temperature Sensor	If outdoor unit detects the condenser coil temperature sensor open circuit or short circuit for 5-sec successively, condenser coil temperature sensor malfunction will be reported. The unit can automatically resume operation after the malfunction disappears. If condenser temperature sensor malfunction occurs in fan mode, only the error code is displayed and the indoor unit will operate normally.
11	F3	Outdoor Ambient Temperature Sensor Malfunction	Outdoor Ambient Temperature Sensor	If outdoor unit detects the outdoor ambient temperature sensor open circuit or short circuit for 5-sec successively, outdoor ambient temperature sensor malfunction will be reported. The unit can automatically resume operation after the malfunction disappears. If outdoor ambient temperature sensor malfunction occurs in fan mode, only the error code is displayed and the indoor unit will operate normally.
12	F4	Compressor Discharge Temperature Sensor Malfunction	Compressor Discharge Temperature Sensor	If outdoor unit detects the compressor discharge temperature sensor is open circuit or short circuit for 5-sec successively after the compressor has been operating for 3-min, outdoor discharge temperature sensor malfunction will be reported. The unit can automatically resume operation after the malfunction disappears.
13	F5	Wired Controller Temperature Sensor Malfunction	Wired Tether Controller Temperature Sensor	If the wired Tether Controller detects open circuit or short circuit of its temperature sensor for 5-sec successively, wired controller temperature sensor malfunction will be reported.

DIAGNOSTIC CODES

Error Codes

No.	Error Code	Malfunction Name	Origin of Malfunction	Description
14	ee	Outdoor Drive Memory Chip Malfunction	Outdoor Drive Board	If the memory chip of outdoor drive circuit board fails, the unit will not start. The unit will not recover automatically. If thermo junction cannot be eliminated after switching off the unit and then energizing the unit several times, replace the outdoor drive circuit board.
15	H3	Compressor Overload Protection	Compressor Overload Switch	If outdoor unit detects the compressor overload switch open within 3-sec successively, the unit will report compressor overload protection. If the fault occurs successively 3 times, the unit will not recover automatically. Switch off the unit or re-energize the unit to eliminate this protection.
16	H4	Overload Protection	Evaporator Temperature, Condenser Temperature	If indoor unit detects the evaporator coil temperature is higher than protective temp. value, the unit will report overload protection. The unit will restart operation after evaporator temperature is lower than the protective temp. value and the compressor is stopped for 3-minutes. If the protection occurs over 6 times, the unit will not recover automatically. Switch off the unit or re-energize the unit to eliminate this protection.
17	H6	Outdoor Fan Motor Malfunction	Outdoor Fan Motor	If outdoor unit does not receive feedback signal from outdoor fan motor for 30-sec successively when the fan motor is operating, an outdoor fan motor malfunction will be reported. In this case, the unit can automatically resume operation after stopping. If the malfunction occurs 6 times within one hour, the unit will not recover automatically. Switch off the unit or re-energize the unit to eliminate this malfunction.
18	U7	Reversing or 4-way Valve Malfunction	Reversing/ 4-way Valve	After the compressor starts operation in heating mode, if the outdoor unit detects the difference between evaporator temperature and indoor ambient temperature is lower than the protective value for 10-min successively, Reversing Valve Malfunction will be reported and the outdoor unit will stop operation. If the malfunction occurs 3 times, the unit will not recover automatically. Switch off the unit or re-energize the unit to eliminate this malfunction.
19	P6	Main Control and Drive Communication Malfunction	Communication Failure Between Indoor and Outdoor Main Board	If the outdoor main control board does not receive data from drive board, communication malfunction between main control and drive will be reported. The malfunction will be eliminated automatically.
20	EE	Outdoor Main Control Memory Chip Malfunction	Outdoor Main Control Board	If the memory chip on the outdoor main control board fails, the unit will not start. The unit will not recover automatically. If thermo junction cannot be eliminated after switching the unit off and on for several tries, replace the outdoor main control board.



GREE ELECTRIC APPLIANCES, INC.

www.greecomfort.com

PRODUCT & INSTALLATION RECORD

For your convenience, please record the model and serial numbers of your new equipment in the spaces provided. This information, along with the installation data and dealer contact information, will be helpful should your system require maintenance or service.

UNIT INFORMATION

Outdoor Unit:

Model No. _____

Serial No. _____

Indoor Unit:

Model No. _____

Serial No. _____

INSTALLATION INFORMATION

Date Installed: _____

DEALERSHIP/INSTALLER INFORMATION

Company Name: _____

Address: _____

Phone Number: _____

Technician Name: _____

