



Owner's Manual

Original Instructions

Down Discharge Kit

Model:

CF8081

CF8082

Thank you for choosing commercial air conditioners. Please read this Owner's Manual carefully before operation and retain it for future reference.

If you have lost the Owner's Manual, please contact the local agent or visit www.gree.com or send an email to global@cn.gree.com for the electronic version.

GREE ELECTRIC APPLIANCES, INC. OF ZHUHAI

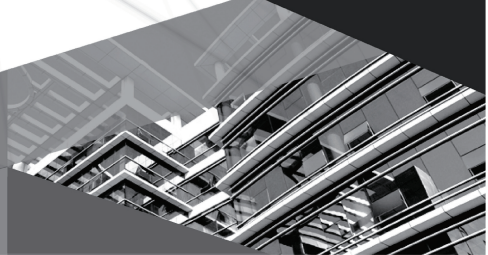

To Users

Thank you for selecting Gree product. Please read this instruction manual carefully before installing and using the product, so as to master and correctly use the product. In order to guide you to correctly install and use our product and achieve expected operating effect, we hereby instruct as below:

- (1) This appliance is not intended for use by persons (including children) with reduced physical, sensory or mental capabilities, or lack of experience and knowledge, unless they have been given supervision or instruction concerning use of the appliance by a person responsible for their safety. Children should be supervised to ensure that they do not play with the appliance.
- (2) In order to ensure reliability of product, the product may consume some power under stand-by status for maintaining normal communication of system and preheating refrigerant and lubricant. If the product is not to be used for long, cut off the power supply; please energize and preheat the unit in advance before reusing it.
- (3) Please properly select the model according to actual using environment, otherwise it may impact the using convenience.
- (4) This product can't be installed at corrosive, inflammable or explosive environment or the place with special requirements, such as kitchen. Otherwise, it will affect the normal operation or shorten the service life of the unit, or even cause fire hazard or serious injury. As for above special places, please adopt special air conditioner with anti-corrosive or anti-explosion function.
- (5) If the product needs to be installed, moved or maintained, please contact our designated dealer or local service center for professional support. Users should not disassemble or maintain the unit by themselves, otherwise it may cause relative damage, and our company will bear no responsibilities.
- (6) All the illustrations and information in the instruction manual are only for reference. In order to make the product better, we will continuously conduct improvement and innovation. If there is adjustment in the product, please subject to actual product.

Exception Clauses

Manufacturer will bear no responsibilities when personal injury or property loss is caused by the following reasons:

- (1) Damage the product due to improper use or misuse of the product.
- (2) Alter, change, maintain or use the product with other equipment without abiding by the instruction manual of manufacturer.
- (3) After verification, the defect of product is directly caused by corrosive gas.
- (4) After verification, defects are due to improper operation during transportation of product.
- (5) Operate, repair, maintain the unit without abiding by instruction manual or related regulations.
- (6) After verification, the problem or dispute is caused by the quality specification or performance of parts and components that produced by other manufacturers.
- (7) The damage is caused by natural calamities, bad using environment or force majeure.

Contents



1 Installation Instructions of Down Discharge Kit.....	1
1.1 Down Discharge Kit (CF8081)	1
1.2 Down Discharge Kit (CF8082)	3
2 Installation Instructions	5
2.1 Disassemble Panel, Water Tray Assembly And Other Sheet Metal Parts (CF8081).....	5
2.2 Install Panel, Water Tray Assembly And Other Sheet Metal Parts (CF8081)	7
2.3 Disassemble Panel, Water Tray Assembly And Other Sheet Metal Parts (CF8082).....	11
2.4 Install Panel, Water Tray Assembly And Other Sheet Metal Parts (CF8082)	14

1 Installation Instructions of Down Discharge Kit

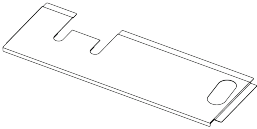

Function of down discharge kit is to enable the indoor unit to realize the installation of down discharge.

1.1 Down Discharge Kit (CF8081)

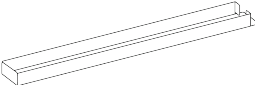
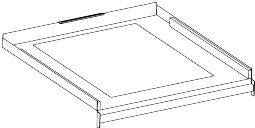
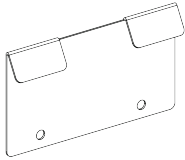
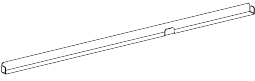
The standard accessory parts listed below are furnished and should be used as required.







No.	Name	Appearance	Q'ty
1	Lower cover plate assembly 1		1
2	Lower cover plate assembly 3		1
3	Mounting plate 1		2
4	Mounting plate assembly 2		1
5	Mounting plate 3		1
6	Mounting plate 4		1

Down Discharge Kit

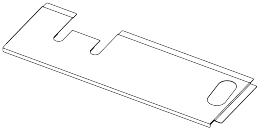

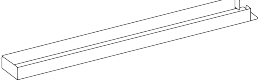
No.	Name	Appearance	Q'ty
7	Screw		36
8	Screw (HWA4.8X21)		4

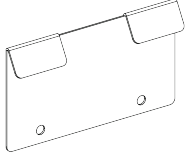
1.2 Down Discharge Kit (CF8082)

The standard accessory parts listed below are furnished and should be used as required.

No.	Name	Appearance	Q'ty
1	Lower cover plate assembly 1		1
2	Lower cover plate assembly 3		1
3	Mounting plate 2		2
4	Mounting plate assembly 1		1
5	Mounting plate 3		1
6	Mounting plate 4		1
7	Glass fiber cotton		4

Down Discharge Kit

No.	Name	Appearance	Q'ty
8	Screw		39
9	Screw (HWA4.8X21)		4

2 Installation Instructions

2.1 Disassemble Panel, Water Tray Assembly And Other Sheet Metal Parts (CF8081)

- (1) Remove the panel:

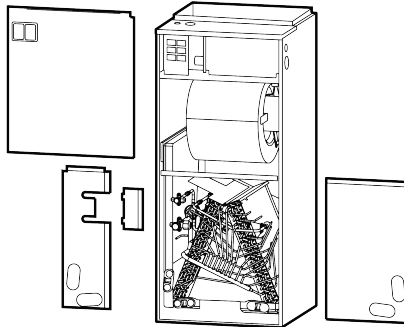

Remove the 28 screws of panel.

- (2) Remove the reinforcing beam:

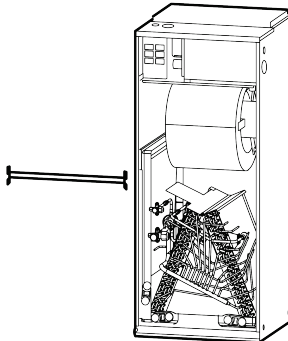

Remove the 4 screws of reinforcing beam.

- (3) Remove the fixing plate of water tray:

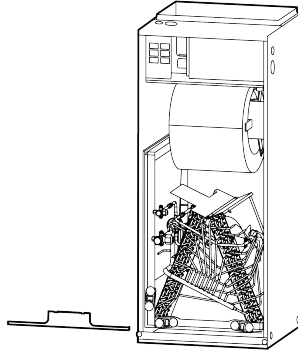

Remove the 2 screws for fixing plate of water tray.

- (4) Remove the water tray assembly:

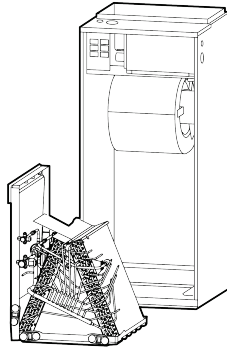

- (5) Remove the auxiliary water tray:

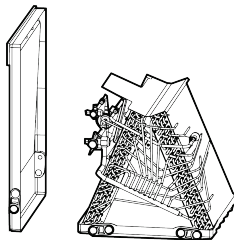

- (6) Overturn the unit:

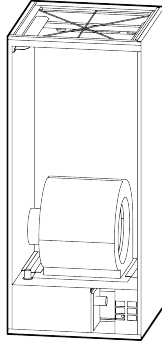

2.2 Install Panel, Water Tray Assembly And Other Sheet Metal Parts (CF8081)

- (1) Assemble mounting plate 2:

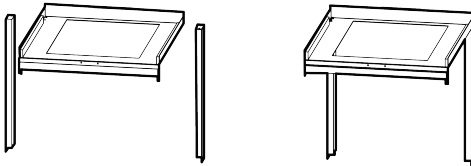

Assemble the mounting plate 2 with 4 screws.

- (2) Install the assembled mounting plate 2:

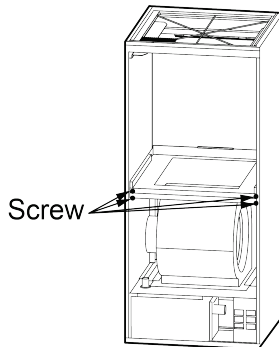

Install the assembled mounting plate 2 with 4 screws.

(3) Install water tray assembly:

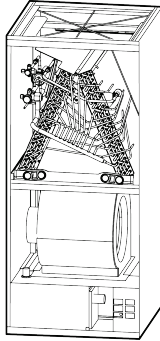

(4) Install mounting plate 3:

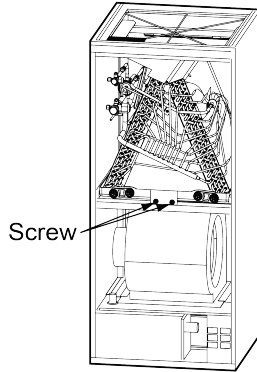

Secure the mounting plate 3 with 2 screws.

- (5) Install mounting plate 4:

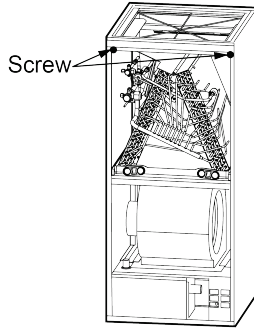

Secure the mounting plate 4 with 2 screws.

- (6) Install lower cover plate assembly 1:

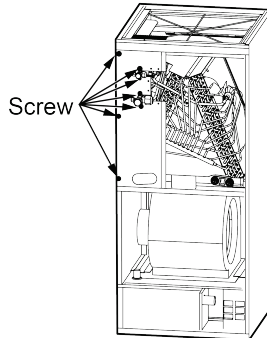

Fix the lower cover plate assembly 1 with 7 screws, including 4 screws (HWA4.8X21) for fixing the check valve.

- (7) Install lower cover plate assembly 2:

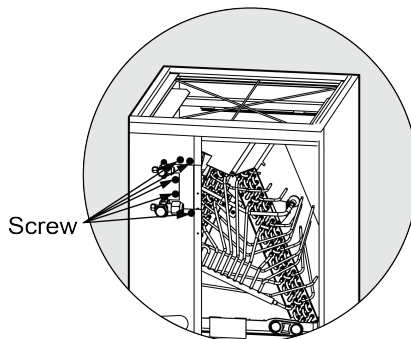

Secure the lower cover plate assembly 2 with 6 screws.

- (8) Install the lower cover plate assembly 3:

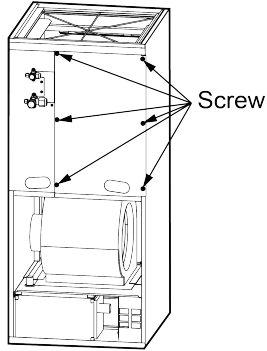

Secure the lower cover plate assembly 3 with 6 screws.

- (9) Install the upper cover plate assembly:

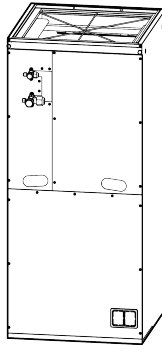

Secure the upper cover plate assembly with 9 screws.

2.3 Disassemble Panel, Water Tray Assembly And Other Sheet Metal Parts (CF8082)

- (1) Remove the panel:

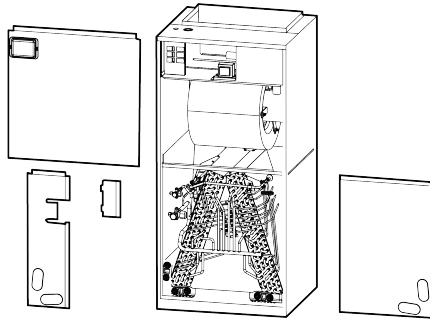

Remove the 31 screws of the panel.

- (2) Remove reinforcing beam:

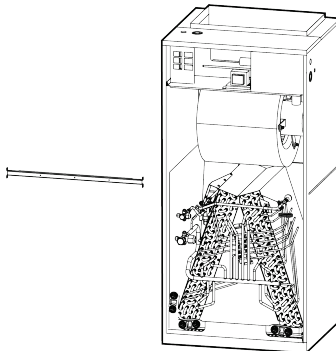

Remove the 4 screws of reinforcing beam.

- (3) Remove fixing plate of water tray:

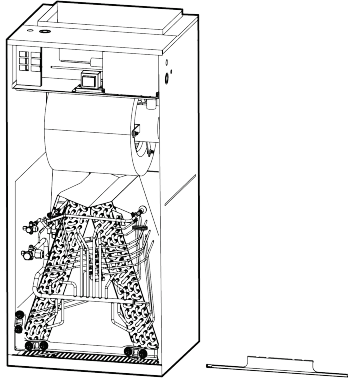

Remove the 2 screws for fixing plate of water tray.

- (4) Remove the water tray assembly:

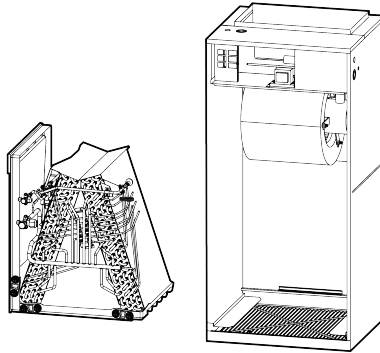

- (5) Remove the auxiliary water tray:

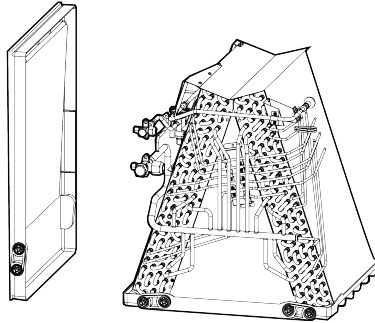

- (6) Remove the seal plate of filter:

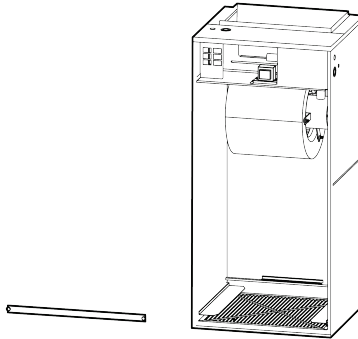

Remove the 2 screws from the seal plate of filter.

- (7) Draw out the filter sub-assy:

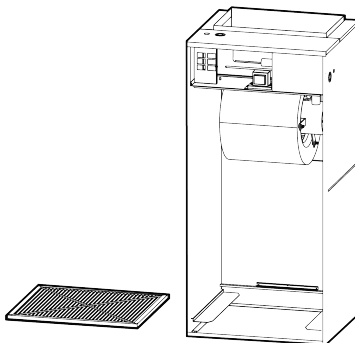

(8) Overturn the unit:

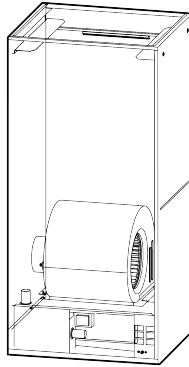

2.4 Install Panel, Water Tray Assembly And Other Sheet Metal Parts (CF8082)

(1) Install glass fiber cotton:

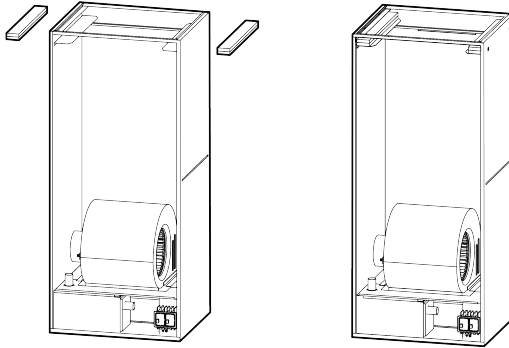

Stack 2 pieces of glass fiber cotton on top of each other and place them on the filter support (water tray).

- (2) Install the filter assembly:

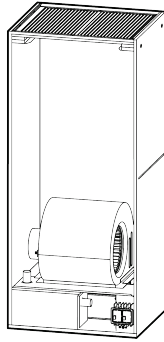

- (3) Install the seal plate of filter:

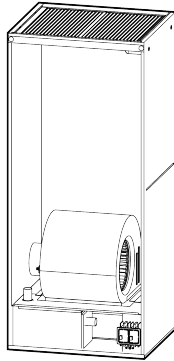

Secure the seal plate with 2 screws.

- (4) Assemble the mounting plate assembly:

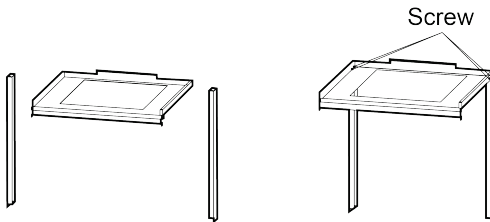

Assemble the mounting plate assembly with 4 screws.

- (5) Install the assembled mounting plate assembly:

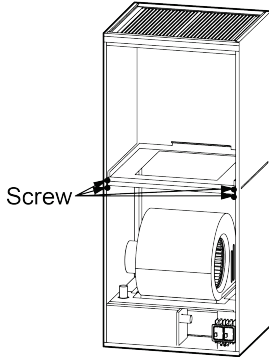

Secure the mounting plate assembly with 4 screws.

- (6) Install the water tray assembly:

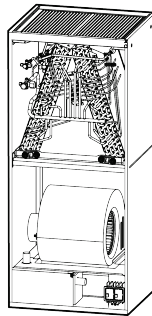

- (7) Install the mounting plate 3:

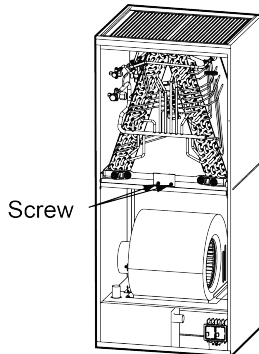

Secure the mounting plate 3 with 2 screw

(8) Install mounting plate 4:

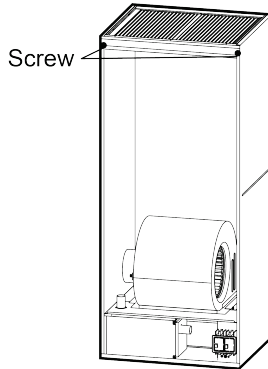

Secure the mounting plate 4 with 2 screws.

(9) Install lower cover plate assembly 1:

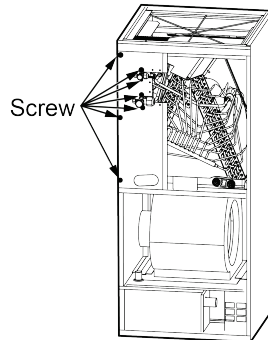

Fix the lower cover plate 1 with 7 screws, including 4 screws (HWA4.8X21) for fixing the check valve.

(10) Install the lower cover plate assembly 2:

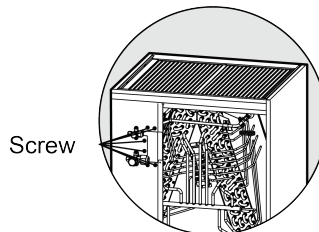

Secure the lower cover assembly 2 with 6 screws.

(11) Install the lower cover assembly 3:

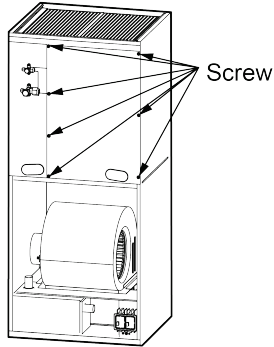

Secure the lower cover plate assembly 3 with 6 screws.

(12) Install the upper cover plate assembly:

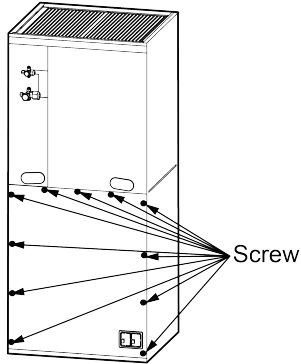

Secure the upper cover plate assembly with 11 screws.

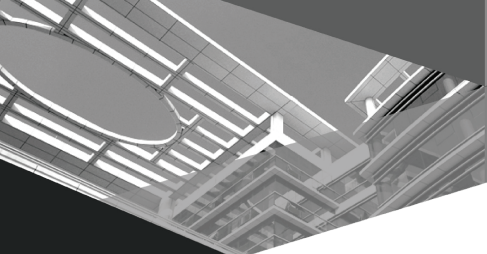

GREE ELECTRIC APPLIANCES, INC. OF ZHUHAI

Add: West Jinji Rd, Qianshan, Zhuhai, Guangdong, China, 519070

Tel: (+86-756) 8522218

Fax: (+86-756) 8669426

E-mail: global@cn.gree.com www.gree.com



600005067211