



***livo+***

**HIGH-WALL DUCTLESS  
AIR CONDITIONING & HEATING SYSTEM  
OWNER'S MANUAL**

---

*Models:*

*LIVS09HP115V1B*

*LIVS12HP115V1B*

*LIVS09HP230V1B*

*LIVS12HP230V1B*

*LIVS18HP230V1B*

*LIVS24HP230V1B*

*LIVS30HP230V1B*

*LIVS36HP230V1B*

*LIVS36HP230V1C*



# ***Thank you for choosing a Livo Heat Pump System!***

*You can feel confident in your selection because the same pride in craftsmanship and engineering knowledge that goes into millions of other Gree installed products worldwide has gone into your unit.*

*Please read this owner's manual carefully before operation and retain it for future reference.*

## ***Table of Contents***

<i>Introduction</i>	<i>2</i>
<i>Nomenclature</i>	<i>2</i>
<i>Safety Precautions</i>	<i>3-4</i>
<i>Installation Schematic</i>	<i>5</i>
<i>System Functions</i>	<i>6-8</i>
<i>Operation of Wireless Remote Controller</i>	<i>9-16</i>
<i>Care and Cleaning</i>	<i>17</i>
<i>Troubleshooting</i>	<i>18-19</i>
<i>Energy Saving Tips</i>	<i>20</i>
<i>Warranty</i>	<i>Back</i>

# INTRODUCTION

---

## Superior Design for Superior Performance

Gree's Livo Inverter-driven, Mini Split Heat Pumps are beautifully designed to deliver effective cooling or heating, while fitting unobtrusively into any decor. The indoor unit's aesthetically pleasing, minimalist design blends nicely in any home or office.

Your Livo unit offers quiet, energy-efficient comfort, powered by Gree's famous G10 Inverter technology. To speed the process of bringing conditioned air exactly where you want it, the unit features both horizontal and vertical air flow control. Customizable mode controls allow you to adjust fan speeds, select sleep-time settings and more, all through the easy-to-use wireless remote controller, or an optional Wired Tether Controller.

There's even a Turbo, Power Failure Memory and other advanced features to make the Livo system even more versatile, for year-round comfort and energy savings.

## NOMENCLATURE

---

Example: LIVS24HP230V1BH

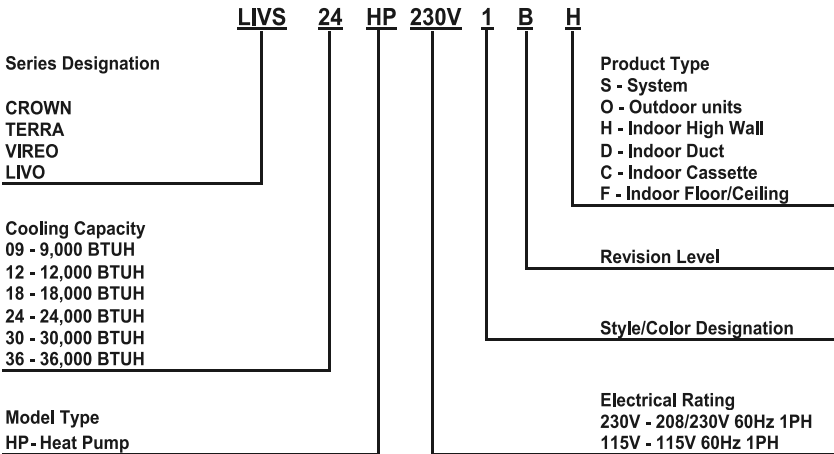

# SAFETY PRECAUTIONS

---

## **Please read the following before operation.**

Recognize safety information.  This is the safety-alert symbol. When you see this symbol on the unit and in instructions or manuals, be alert to the potential for personal injury. Understand these signal words: **DANGER**, **WARNING**, and **CAUTION**. These words are used with the safety-alert symbol.

**DANGER** identifies the most serious hazards which will result in severe personal injury or death.

**WARNING** signifies hazards which could result in personal injury or death.

**CAUTION** is used to identify unsafe practices which may result in minor personal injury or product and property damage.

**NOTE** is used to highlight suggestions which will result in enhanced installation, reliability, or operation.

**NOTE:** Your actual air conditioning & heating system and related devices may differ from the images shown in this manual.

### **WARNING**

This appliance is not intended for use by children without responsible adult supervision. Proper care should be taken to ensure safety.

### **WARNING**

Heat pumps, air conditioners & heating equipment should be installed, started up, and serviced only by qualified installers and service technicians. Air conditioning, heat pumps and refrigeration systems are hazardous due to high voltage electrical components, high refrigerant pressures, and moving parts.

### **WARNING**

- Disconnect electrical power to the indoor and outdoor units before performing any maintenance or cleaning.
- Do not attempt to repair the Gree system yourself. Incorrect repairs may cause electric shock or fire. Contact a qualified service technician for all service requirements.
- Keep combustible materials away from the unit.





# SAFETY PRECAUTIONS

**Please read the following before operation.**

## **CAUTION**

- Do not put hands or any objects into the air inlets or outlets. This may cause personal injury or damage the unit.
- When cleaning, be careful not to splash water on the unit. Doing this may cause electric shock or damage to unit.
- Do not use or place any flammable, combustible or noxious substance next to the unit.
- In the event of a failure (burning smell, etc.), immediately disconnect all electrical power to indoor and outdoor units.
- Never try repairing the system yourself; contact a qualified service technician for all repairs.

### Icons Displayed

	: COOL
	: DRY
	: HEAT
	: POWER
88	: SET TEMP



### Front Panel Display

The front panel on the Livo indoor unit contains system status lights and easy-to-read LED display.

**NOTE:** The indoor unit display panel can be turned ON or OFF via the LIGHT button on the remote controller. See "LIGHT" button description for more detail.

# INSTALLATION SCHEMATIC

## Indoor unit

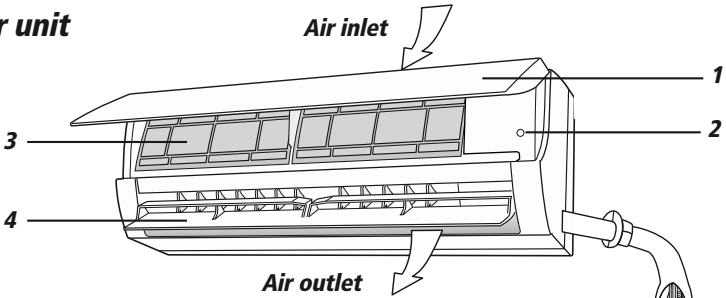

## Installation Components\*

1. Front Panel
2. Aux. Button
3. Air Filter
4. Horizontal Louver
5. Remote Controller
6. X-41 Wired Tether Controller (sold separately)
7. Inter-Connection Wire (sold separately)
8. Drain Hose (sold separately)
9. Refrigerant Lines (sold separately)

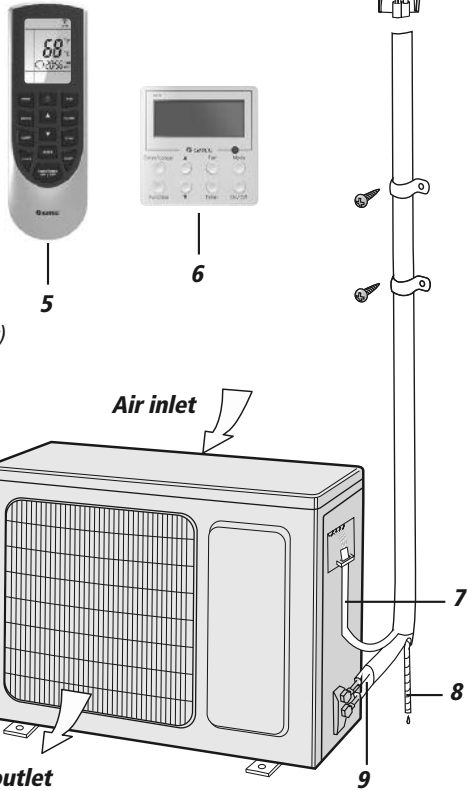

\* Not all items in this schematic are included with equipment purchase

## Outdoor unit

## **SYSTEM FUNCTIONS**

---

### **WHISPER QUIET**

*Not only are the Gree systems energy efficient but they are quiet too. Livo High-Wall units operate with sound pressure levels starting as low as 28 dB(A).*

### **MULTI FAN SPEEDS**

*Whether operating in either Cooling or Heating mode, the indoor fan can be set to your choice of four different speeds (Low, Medium, High or Turbo) to achieve maximum comfort.*

### **INTELLIGENT PRE-HEATING**

*The Livo system guards against the annoying cool air blown into the room in heating mode. The system constantly monitors the discharge air temperature. It will delay the indoor fan until the indoor coil has warmed up to prevent blowing uncomfortable cool air into the room.*

### **I FEEL MODE**

*The unit will sense room temperature at the remote controller instead of at the indoor unit during cooling mode. It then adjusts airflow and temperature accordingly for the ultimate in personal comfort control and energy savings.*

### **ADJUSTABLE AIRFLOW**

*The Livo system has a bi-directional airflow control for maximum comfort. The indoor unit has adjustable vertical swing louvers and can be set in multiple discharge directions from the wireless remote controller.*

### **TURBO MODE**

*Use Turbo Mode for situations where you wish to achieve the desired room temperature in the shortest possible time. This mode runs the unit at ultra high speeds for quickest results.*

### **FREEZE GUARD**

*Room Freeze Guard protection will automatically keep the room temperature from getting too cold, where water pipes might freeze*

### **TIMER MODE**

*The unit can be programmed to turn ON or OFF after a specific amount of time. The time period is adjustable between one half and 24 hours.*

# SYSTEM FUNCTIONS

---

## **MODE BUTTON**

The unit can be set to five different operating modes: HEAT, COOL, DRY, FAN ONLY and AUTO.

**NOTE:** AUTO MODE has fixed setpoints of 68° F heating and 77° F cooling, which are not adjustable. The system will automatically select heating or cooling to maintain room temperature within this band.

## **SLEEP MODE**

The Livo offers a Sleep Mode function for your comfort. The unit will automatically adjust room temperature during your sleep time. This slight change in temperature will not affect your comfort level due to the natural effects that sleeping has on the body, but it will save on energy consumption and will lower electric bills.

## **ENERGY SAVINGS MODE**

This feature will automatically select the optimal compressor and fan speeds to allow for energy savings while operating in Cooling or Heating modes. The compressor and fan will automatically slow down as the room temperature reaches the set point.

## **SELF-DIAGNOSIS**

Livo has a built-in computer which uses real-time diagnostics which help prolong the unit's life. The automatic diagnosis feature continuously scans for errors or malfunctions and fault codes are shown on the unit display to facilitate troubleshooting and repair.

## **POWER FAILURE MODE**

Power interruptions are no problem for the Livo system. User selections and system parameters are stored in non-volatile memory. These parameters are retained during a power failure. When power is returned, the Livo system will automatically return to the last operating mode.

## **INTELLIGENT DEFROST**

The Livo Intelligent Defrost function increases room comfort and saves energy by eliminating unnecessary defrost cycles. In heating mode, the unit will monitor the outdoor coil for frost build up. Once frost buildup has been detected, the system will switch into a defrost mode to remove the frost.



# **SYSTEM FUNCTIONS**

---

## **POLYMERIC AIR FILTER**

*The polymeric mesh filters save energy by preventing the indoor coils from being plugged with dirt and lint. This economical and sturdy filter may be washed, vacuumed and reused.*

## **FAHRENHEIT °F / CELSIUS °C**

*The remote controller and indoor wall unit front panel can be set to display in either °F or °C.*

## **PRIVACY LOCK MODE**

*The wireless remote controller has a Lock feature. The Lock averts unauthorized access or tampering with system settings.*

## **AGENCY LISTINGS**

*All systems are listed with AHRI (Air conditioning, Heating, and Refrigeration Institute) and are ETL certified per UL Standards.*

# OPERATION OF WIRELESS REMOTE CONTROLLER

## Remote Controller

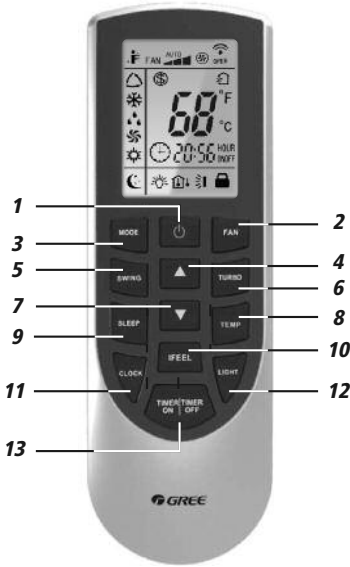

### Part Name

1. ON/OFF Button
2. Fan Button
3. Mode Button
4. Up Button
5. Swing Button
6. Turbo Button
7. Down Button
8. Temp Button
9. Sleep Button
10. I Feel Button
11. Clock Button
12. Light Button
13. Timer On/Off Button

## INTRODUCTION FOR ICONS ON DISPLAY SCREEN

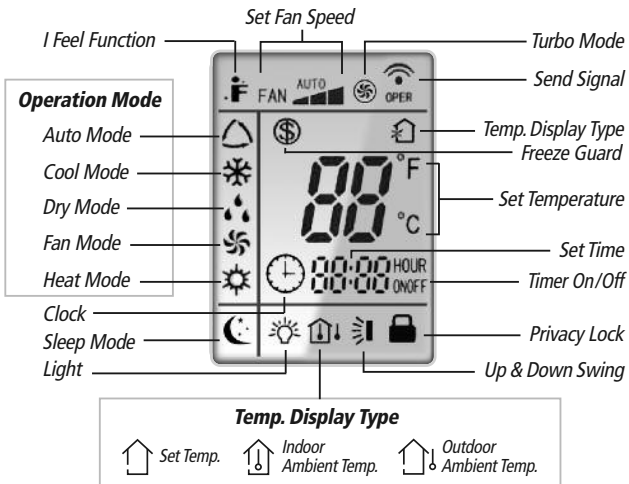

# OPERATION OF WIRELESS REMOTE CONTROLLER

## REMOTE CONTROLLER OPERATIONS

The wireless remote controller is sleek, versatile and allows you to change room temperatures and functions on your Vireo system from the palm of your hand. The large LCD display and buttons make it easy-to-understand and easy-to-use.

The remote controller is set from factory to display temperatures in °F. If °C is desired, turn the remote controller **OFF** with the **ON/OFF** button and then press "**MODE**" and "**▼**" buttons on the remote simultaneously for 5 seconds.

### ON/OFF BUTTON

When the system is in **OFF** mode, the remote controller will display the time and last room setpoint. When you press the **ON/OFF** button, this indicator  will be displayed and the unit will start in the last operating mode and room setpoint.

**NOTE:** If the **ON/OFF** button is pressed too soon after a stop, the compressor will not start for 1 to 5 min. due to the inherent protection against frequent compressor cycling.



ON Mode Display

### DISPLAYING SETPOINT OR INDOOR TEMPERATURE ON FRONT PANEL:

The setpoint temperature or room temperature can be displayed on the front panel. Only setpoint temperature is displayed on the remote controller.

When the "**TEMP**" button is pushed once, the temperature indicator  is displayed. This indicates that the setpoint temperature is displayed on the front panel.

When the "**TEMP**" button is pushed a second time, the display will show an  icon with a thermometer inside a house. This indicates that the room temperature is displayed on the front panel.

The room temperature will be displayed for only 5 seconds before reverting back to displaying room setpoint.





Room Temperature Display

# OPERATION OF WIRELESS REMOTE CONTROLLER

## VERTICAL SWING LOUVERS

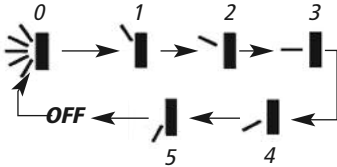
- Press the Vertical Swing Louver button to select five different vertical (up & down) air discharge directions including Continuous Sweep. The Swing Louver  icon will be displayed. Press this button to set swing angle, which changes in direction as below:



 Indicates louver swings up and down in the five directions, as shown.



Swing Louver Display

## PRIVACY LOCK

The Privacy Lock prevents unauthorized access to the unit controls and prevents tampering with system settings. The remote controller can be locked by pushing the "▲" and "▼" buttons simultaneously for 5 seconds. The Privacy Lock icon will be displayed on the remote controller. Repeat the process to unlock the remote controller.



Privacy Lock Display

## I FEEL MODE

Press this button to use the I FEEL function, and the  icon will be displayed. The unit will sense room temperature at the remote controller instead of at the indoor unit during cooling mode. It then adjusts airflow and temperature accordingly for the ultimate in personal comfort control and energy savings. Press the button again to exit this function. For best performance, keep remote controller away from heat or cold temperature sources while using this function.



I Feel Mode

# OPERATION OF WIRELESS REMOTE CONTROLLER

## MODE BUTTON

Use the "**MODE**" button to select one of the available modes. The selected mode will be displayed on the remote controller and the appropriate light will illuminate on the front display panel.

**AUTO** – Unit will automatically select heating or cooling to maintain room temperature between 68°F and 77°F. The remote controller will display the Auto Mode icon with no setpoint.

**COOL** – To cool to selected setpoint and remove moisture. Press ▲ or ▼ to adjust set temperature. System varies compressor speed to maintain desired temperature.

**HEAT** – To heat to selected room setpoint. Press ▲ or ▼ to adjust set temperature. System varies compressor speed to maintain desired room temperature.

**FAN ONLY** – To circulate air without heating or cooling. Use Fan Speed button to select speed from low to high.

**DRY** – Select **DRY MODE** to increase moisture removal during warm humid conditions. In this mode, fan speed cannot be adjusted.

1. If the Room Temperature is more than 4°F above the set temperature, the system will be operating in cooling mode with low fan speed.
2. If the Room Temperature is between 4°F higher than, and 4°F less than, the set temperature, the system will cycle 6 minutes **ON** and 4 minutes **OFF** in cooling mode. The indoor fan will be at low speed.
3. If the Room Temperature is more than 4°F below the set temperature, the system will be **OFF** and the indoor fan will be at low speed.

## FREEZE GUARD

In Heat mode, press "TEMP" and "CLOCK" buttons simultaneously to start up 46°F heating function. When this function is started up, "(\$)" and "46°F" will be displayed on the remote controller, and the unit will maintain room temperature above 46°F. Press "TEMP" and "CLOCK" buttons simultaneously again to cancel Freeze Guard protection.

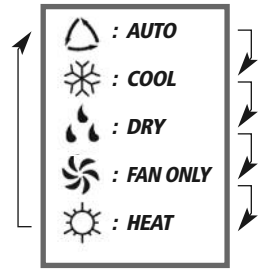

Icons Displayed



Freeze Guard Display

# OPERATION OF WIRELESS REMOTE CONTROLLER

## TIMER SETTING

### Timer-ON / Timer-OFF BUTTON

To set when you want the unit to turn On at the end of a selected time period, use the button labeled "Timer-ON / Timer-OFF" on the remote controller. Press this button to make the clock icon disappear, replaced with the word "ON" (blinking). Press ▲ or ▼ buttons to adjust timer setting 1 minute at a time. Press and hold ▲ or ▼ button to set timer more quickly. Press "Timer-ON / Timer-OFF" button again to confirm setting, and the word "ON" will stop blinking. To cancel, press "Timer-ON / Timer-OFF" button again.



Timer Setting ON/OFF

To set when you want the unit to turn Off at the end of a selected time period, use the same button. Press this button to make the clock icon disappear, replaced with the word "OFF" (blinking). Adjust settings the same as with "Timer-ON / Timer-OFF" settings.

**NOTE:** Under Timer On and Off status, you can set "Timer-ON / Timer-OFF" simultaneously. Before setting timer, be sure to set clock to correct time.

## TURBO MODE

The desired room setpoint can be achieved faster in **TURBO** mode. After selecting the "HEAT" or "COOL" mode button, push the "TURBO" button. The **TURBO** icon will be displayed on the remote controller and the unit will run at an ultra-high speed. To deactivate the feature, push the "TURBO" button again. The unit will return to normal operation.



Turbo Mode Display

# OPERATION OF WIRELESS REMOTE CONTROLLER

## FAN BUTTON

Press the FAN button to adjust the indoor fan speed:

Low (▲), Medium (▲▲), High (▲▲▲), Turbo and Auto.

- Turbo function is not available in Dry and Auto mode.
- The fan operates at low speed in Dry and Auto modes, and the speed cannot be adjusted.
- When Auto is selected, the unit will select the proper fan speed automatically, according to the ambient temperature.

**NOTE:** Turbo function is not available in Dry and Auto Modes. The Livo unit will select proper fan speed automatically according to ambient temperature.



Fan Display

## CLOCK SETTING

Press this button to set clock time. "⌚" icon on remote controller will blink. Within 5 seconds, press ▲ or ▼ button to set clock time. With each pressing of ▲ or ▼ buttons, clock time will increase or decrease 1 minute. To quickly adjust time setting, press and hold ▲ or ▼ button for 2 seconds. Release button when you have reached the desired time setting. Press "CLOCK" button to confirm the time, and "⌚" icon will stop blinking.

**NOTE:** Clock time adopts 24-hour mode. A 12-hour time format is not available.



Clock Setting Display

## LIGHT BUTTON

Press this button to turn off display light on indoor unit. Press again to turn it back on.



Light Display

# OPERATION OF WIRELESS REMOTE CONTROLLER

## ENERGY-SAVING

In Cool mode, press "TEMP" and "CLOCK" buttons simultaneously to start the energy-saving function. "SE" will be shown on remote controller, and the unit will adjust the set temperature automatically to reach to the best energy-saving effect. Press "TEMP" and "CLOCK" buttons simultaneously again to cancel energy-saving mode.



Energy Saving Display

## SLEEP MODE

The Livo system will automatically adjust room temperature during your sleep time. This slight change in temperature will not affect your comfort level due to the natural effects that sleeping has on the body, but it will save on energy consumption and will lower your electric bill. Press the SLEEP button to select Sleep Mode or Cancel. The SLEEP  icon will appear.

In Sleep Mode the unit will slowly relax the room set temperature by up to 4° F until Sleep Mode is cancelled.



Sleep Mode Display

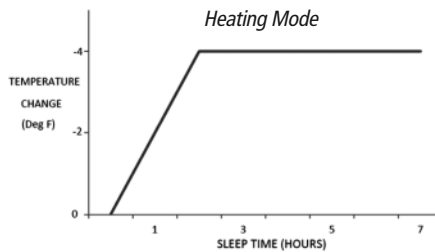
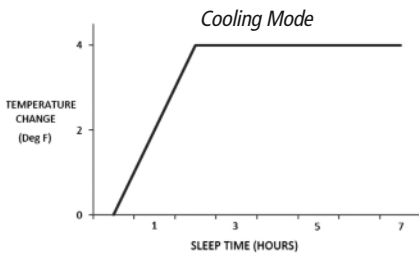



# OPERATION OF WIRELESS REMOTE CONTROLLER

## CHANGING BATTERIES AND ADDITIONAL NOTES

To change batteries, slide cover off battery compartment on back of remote controller. Remove and safely discard old batteries. Insert two new AAA 1.5V dry batteries, using correct polarity. Reattach back cover.

### NOTE:

- If the remote controller will not be used for a long time, remove batteries to prevent leakage damage.
- Be sure to aim the remote controller at the receiver of the main unit when operating.
- When remote emits a signal, icon will flicker; a tone will be heard when unit receives that signal.

## CHANGING BATTERIES

Remove old batteries

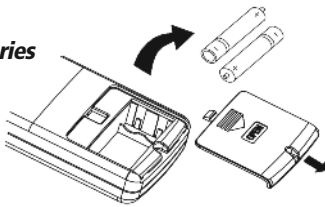

Install new batteries

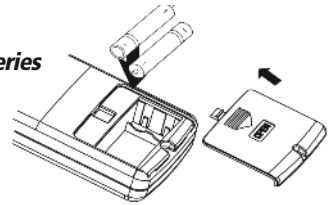

## DAMAGED OR LOST REMOTE CONTROLLER

If remote controller is lost or damaged, the Livo system can be turned off directly from the indoor unit. Lift the front panel of the indoor wall unit, then press the AUX button to turn on or turn off. When the unit is on, it will operate in AUTO Mode.

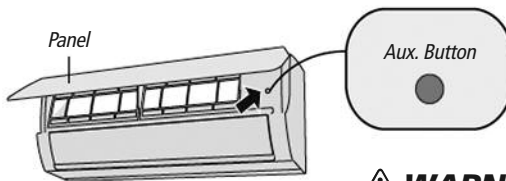

### **!** WARNING

Use insulated object to press the Aux. button.

# CARE AND CLEANING

## **WARNING**

**Take notice of the following items before cleaning your *Live* indoor wall unit.**

- To avoid electric shock or injury, do not attempt to clean the unit unless it has been turned off and the indoor and outdoor units have been disconnected from the main power supply.
- Do not wash the unit with water; this may cause an electric shock.
- During cleaning, be sure to use a stable and safe standing platform.

### **FRONT PANEL CLEANING**

Wash the front panel using warm water and mild detergent with a soft cloth or soft brush.

**NOTE:** Do not use bleach, abrasives or water above 110°F (45°C) as it may cause discoloration or damage to the surface of the unit.

### **AIR FILTER CLEANING**

Changing your air filter on a regular basis prevents many problems. Dirty air filters will affect the performance and the longevity of your unit. It is recommended that air filters be cleaned every three (3) months.

#### **To access and clean the filter:**

1. **Open Front Panel**  
Firmly grasp both sides of the front panel and pull upward to about 60 degree angle. (NOTE: do not force panel open).
2. **Remove Filter**  
Remove the filter as indicated in the figure at right.
3. **Clean Filter**  
Use vacuum to clean the filter.  
When the filter is very dirty, use warm water (below 110°F) to clean it, and then dry filter before replacing.
4. **Reinstall Filter**  
Reinstall the filter and then close the panel cover tightly.

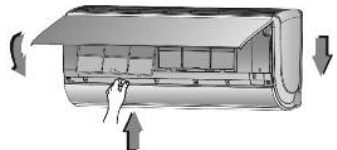
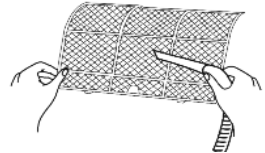
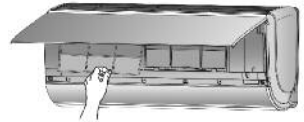
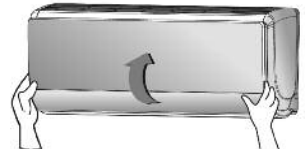

# TROUBLESHOOTING

PROBLEM	CAUSE/SOLUTION
System does not restart.	<p><b>Cause:</b> The system has a built-in three-minute delay to prevent short and/or rapid cycling of the compressor.</p> <p><b>Solution:</b> Wait three minutes for the protection delay to expire.</p>
Indoor unit emits unpleasant odor when started.	<p><b>Cause:</b> Typically unpleasant odors are the result of mold or mildew forming on the coil surfaces or the air filter.</p> <p><b>Solution:</b> Wash indoor air filter in warm water with mild cleaner. If odors persist, contact a qualified service professional to clean the coil surfaces.</p>
You hear a "water flowing" sound.	<p><b>Cause:</b> It is normal for the system to make "water flowing" or "gurgling" sounds from refrigerant pressures equalizing when the compressor starts and stops.</p> <p><b>Solution:</b> The noises should discontinue as the refrigerant system equalizes after two or three minutes.</p>
A thin fog or vapor coming out of the indoor unit when system is running.	<p><b>Cause:</b> It is normal for the system to emit a slight fog or water vapor when cooling extremely humid warm air.</p> <p><b>Solution:</b> The fog or water vapor will disappear as the system cools and dehumidifies the room space.</p>
You hear a slight cracking sound when the system stops or starts.	<p><b>Cause:</b> It is normal for the system to make "slight cracking" sounds from parts expanding and contracting during system starts and stops.</p> <p><b>Solution:</b> The noises will discontinue as temperature equalizes after 2 or 3 minutes.</p>
The system will not run.	<p><b>Cause:</b> There are a number of situations that will prevent the system from running.</p> <p><b>Solution:</b> Check for the following:</p> <ul style="list-style-type: none"> <li>• Circuit breaker is "tripped" or "turned off."</li> <li>• Power button of remote is not turned on.</li> <li>• Batteries in the remote controller are low.</li> <li>• Remote controller is in sleep mode or timer mode.</li> <li>• Otherwise, contact a qualified service professional for assistance.</li> </ul>
The unit is not heating or cooling adequately.	<p><b>Cause:</b> There are a number of reasons for inadequate cooling or heating.</p> <p><b>Solution:</b> Check the following:</p> <ul style="list-style-type: none"> <li>• Remove obstructions blocking airflow into the room.</li> <li>• Clean dirty or blocked air filter that is restricting airflow into the system.</li> <li>• Seal around door or windows to prevent air infiltration into the room.</li> <li>• Relocate or remove heat sources from the room.</li> </ul>
Water leakage from the outdoor unit.	<p><b>Cause:</b> It is normal for the outdoor unit to generate condensate water in the reverse cycle heating and defrost mode.</p> <p><b>Solution:</b> This is normal. No action is required.</p>

# TROUBLESHOOTING

PROBLEM	CAUSE/SOLUTION
<p>Water leaking from the indoor unit into the room.</p>	<p><b>Cause:</b> While it is normal for the system to generate condensate water in cooling mode, it is designed to drain this water via a condensate drain system to a safe location.</p> <p><b>Solution:</b> If water is leaking into the room, it may indicate one of the following.</p> <ul style="list-style-type: none"> <li>• The indoor unit is not level right to left. Level indoor unit.</li> <li>• The condensate drain pipe is restricted or plugged. All restrictions must be removed to allow continuous drainage by gravity.</li> <li>• If problem persists, contact a qualified service professional for assistance.</li> </ul>
<p>Wireless remote controller does not work.</p>	<p><b>Cause:</b> There are a number of possible reasons.</p> <p><b>Solution:</b> Check the following:</p> <ul style="list-style-type: none"> <li>• The batteries might be low. Change the batteries.</li> <li>• The remote controller must be within 25 ft. (7.5 m) with no obstructions of the indoor unit. If remote controller needs to be replaced, contact a qualified service professional for assistance. In the meantime, use the Aux Button to operate the system.</li> </ul>
<p>The unit will not deliver air.</p>	<p><b>Cause:</b> There are a number of system functions that will prevent air flow.</p> <p><b>Solution:</b> Check for the following:</p> <ul style="list-style-type: none"> <li>• In heating mode, the indoor fan may not start for three minutes if the room temperature is very low. This is to prevent blowing cold air.</li> <li>• In heat mode, if the outdoor temperature is low and humidity is high, the system may need to defrost for up to 10 minutes before beginning a heating cycle.</li> <li>• In dry mode, the indoor fan may stop for up to three minutes during the compressor off delay.</li> <li>• Otherwise, you should contact a qualified service professional for assistance.</li> </ul>
<p>Moisture or condensation on the discharge air louvers or outlet vents.</p>	<p><b>Cause:</b> It is normal for the system to develop condensation or moisture on the discharge air louvers when cooling warm humid air for a long period of time.</p> <p><b>Solution:</b> The condensation or moisture will disappear as the system cools and dehumidifies the room space.</p>



## CAUTION

### Stop operation and call for service in the following circumstances:

- You hear a harsh or unusual sound during operation.
- Unusually foul odor is emitted during operation.
- Water is leaking in the room.
- You notice a burning smell or see smoke.
- Circuit breaker trips frequently, or unit stops abnormally often.

## ENERGY SAVING TIPS

---

- 1. Reduce room setpoint at night:** During the nighttime hours you don't require the same level of conscious cooling or heating. Try using Sleep Mode to gradually relax room temperature and allow the unit to run less and save energy.
- 2. Curtains and shades:** In the summer, it is recommended to block the effects of the sun. Close window curtains and shades on the south and west side of your home to help block solar heat. In winter, the sun is your friend. Open curtains and shades to allow solar heat into your room.
- 3. Close doors:** If you don't need to heat and cool your whole home, confine the heating and cooling to one room by closing doors.
- 4. Service the unit:** Some basic maintenance might be all you need. The outdoor unit will greatly benefit from a good hosing off, especially in treed areas where seeds and other debris can stick to coil fins and make the unit work up to 15% harder!
- 5. Rearrange the room:** Furniture that obstructs airflow means you could be heating and cooling the back of a chair instead of the actual living space. Remove or rearrange obstacles blocking airflow.
- 6. Try 75 degrees:** 75°F is a good point for an air conditioner to run at its optimal performance level. Even a 5-degree change in temperature can make your unit use up to 40% more energy.
- 7. Lighting:** Turning lights off can help reduce your heat. Each light bulb is a tiny heater. Your air conditioner must waste energy overcoming the heat from your lights to reach and hold your desired room temperature.
- 8. Is anyone home?** If possible, while you're away turn your unit to Auto mode and make sure windows and curtains are closed. Although room temperature may be less than optimal for a few minutes when you return, the unit will soon have the room back to your desired temperature.
- 9. Don't forget the fan:** The fan is much like a car. The faster it runs, the more energy it uses. Sometimes we need the car to go fast, but slow is good enough most of the time. Try saving money by using the comfortable quiet low fan speed as much as possible.



## **LIMITED WARRANTY STATEMENT**