



Multi-Room Ductless heat-pump systems

Submittal Data: MULTI24HP230V1BO 24,000 BTU/H Wall Mounted Heat- Pump System

Job Name Location Date

Purchaser Engineer

Submitted To For Reference Approval Construction

Unit Designation Schedule No.

- GENERAL FEATURES**
- Up to 3 Indoor Units Comfort (3-Port)
 - G10 DC Inverter Technology
 - Quiet Operation - Both Indoor & Outdoor
 - Wireless Remote Controller
 - Acrylic Resin/Anti-Corrosion Coil Protection Inside & Out
 - Intelligent Defrost
 - Auto Restart on Power Outages
 - Multi-point Diagnostics
 - Limited 7 yr Compressor & 5 yr Parts Warranty



System Ratings

Non-Ducted Indoor		
Rated Cooling Capacity		26000 BTUH
Cooling Capacity (min-max)		7,500-33,000 BTUH
Rated Heating Capacity		29000 BTUH
Heating Capacity (min-max)		7,500-35,000 BTUH
SEER/EER		20.5/9.5
HSPF/COP		10.2/3.7
Ducted Indoor		
Rated Cooling Capacity		26000 BUTH
Cooling Capacity (min-max)		7,500-33,000 BTUH
Rated Heating Capacity		29000 BTUH
Heating Capacity (min-max)		7,500-35,000 BTUH
SEER/EER		14/9.5
HSPF/COP		9.0/3.0

Operating Range

Cooling	(min-max)	0 ~ 118°F
		-18 ~ 48°C
Heating	(min-max)	-4 ~ 75°F
		-20 ~ 24°C

Power Supply

Normal Operational Voltage	208/230 V, 1 Phase, 60 Hz
Voltage Range	187 - 253 V
Main Power Wire Size	8-2 AWG
Interconnecting Cable Wire Size	14-4 AWG
MCA	22.0 A
MOCP/Breaker Size	35 A

Outdoor Unit Data

Compressor	Type	DC Inverter Driven Rotary
	RLA	17.0 A
Fan Motor	Output Power	90 W
	FLA	0.6 A
	Air Flow (Max)	2354 CFM
Sound Pressure	Cooling	59 db(A)
	Heating	59 db(A)
Dimensions & Weights	Unit Dimensions (LxHxD)	38.6 x 31.1 x 17.3 -in
	Weight (Net/Shipping)	153/164 LBS
	Min. Number of Indoor Units	2
	Max. Number of Indoor Units	3

Refrigerant Piping Data

Refrigerant Type	R410A
Refrigerant Charge	77.6 oz
Additional Charge Per Line Length	0.21-oz/ft
Connection Method	Fared
Factory Charge for Total Line Length	98-ft
Total Refrigerant Pipe Length	197-ft
Max Refrigerant Piping Length to any Indoor Unit	65-ft
Min Refrigerant Piping Length to any Indoor Unit	10-ft
Max Elevation between Indoor Units	33-ft
Max Lift from Outdoor to Indoor Unit	33-ft
Max Drop from Outdoor to Indoor Unit	33-ft



Units: inch



24,000 BTUH MODEL

Model # MULTI24HP230V1BO 24,000 BTUH 230V

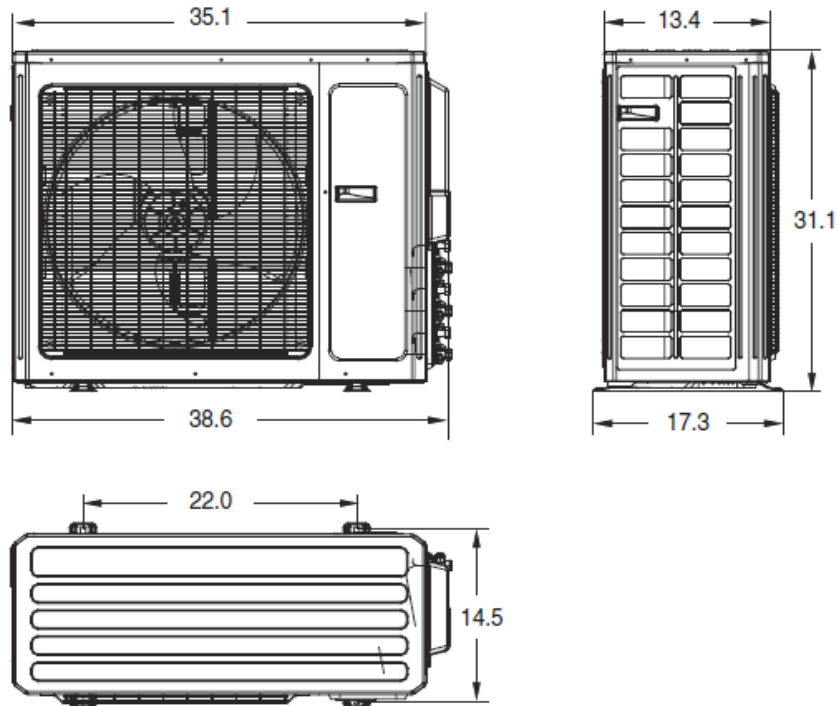

Suction/Gas Line Port Size

Port #1	3/8-in OD Flared
Port #2	3/8-in OD Flared
Port #3	3/8-in OD Flared

Liquid Line Port Size

Port #1	1/4-in OD Flared
Port #2	1/4-in OD Flared
Port #3	1/4-in OD Flared

MINIMUM SPACING REQUIREMENTS

Units: inch (mm)

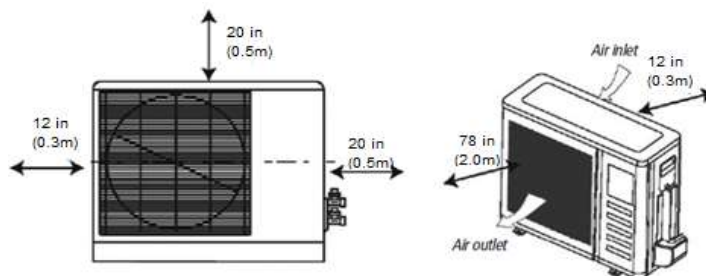

Notes:

1. Recommended Interconnecting Cable Type Stranded Copper Conductors THHN 600V Unshielded Wire
2. Power wiring cable size must comply with applicable national and local codes.
3. Test conditions are based on AHRI 210/240.

Specifications are subject to change without notice. Manufacturer reserves the right to discontinue or modify specifications or designs without notice or without incurring obligations. All rights reserved.

INDOOR DUCTLESS DIMENSIONAL SPECIFICATIONS

MULTI24HP230V1BO

Units: inch



9,000 AND 12,000 BTUH MODELS

Model # VIR09HP230V1AH 9,000 BTUH 230V

Model # VIR12HP230V1AH 12,000 BTUH 230V

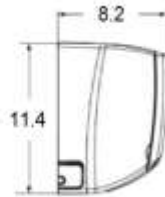
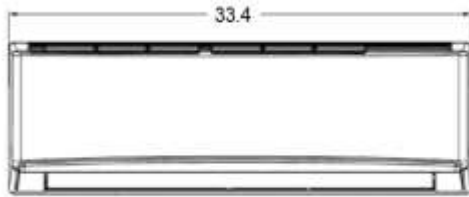

9,000 BTU	
Liquid Line Valve	1/4-in OD Flared
Suction/Gas Line Valve	3/8-in OD Flared
Drain Connector	5/8-in OD

12,000 BTU	
Liquid Line Valve	1/4-in OD Flared
Suction/Gas Line Valve	1/2-in OD Flared
Drain Connector	5/8-in OD

Note: Size Refrigerant lines based on evaporator port sizes.

Indoor Capacity Size	Rated Cooling	Rated Heating	Max. CFM	Dehum (Pt/Hr)	Min/Max Sound Power dB(A)**
9,000 BTUH	9,000	11,000	377	1.7	29/43
12,000 BTUH	12,000	13,000	400	3.0	29/45

18,000 BTUH MODEL

Model # VIR18HP230V1AH 18,000 BTUH 230V

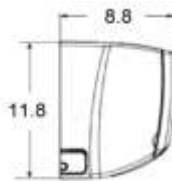
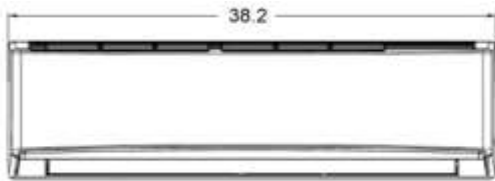

Liquid Line Valve	1/4-in OD Flared
Suction/Gas Line Valve	5/8-in OD Flared
Drain Connector	5/8-in OD

Note: Size Refrigerant lines based on evaporator port sizes.

Rated Cooling (BtuH)	Rated Heating	Max. CFM	Dehumid. (Pt/Hr)	Min/Max Sound Power dB(A)**
18,000	19,800	559	3.8	39/47

**Sound Power ratings are per AHRI 270 and AHRI 350

Specifications are subject to change without notice. Manufacturer reserves the right to discontinue or modify specifications or designs without notice or without incurring obligations. All rights reserved.

Units: inch (mm)

9,000 AND 12,000 BTUH MODELS



Model # TERRA09HP230V1AH 9,000 BTUH 230V

Model # TERRA12HP230V1AH 12,000 BTUH 230V

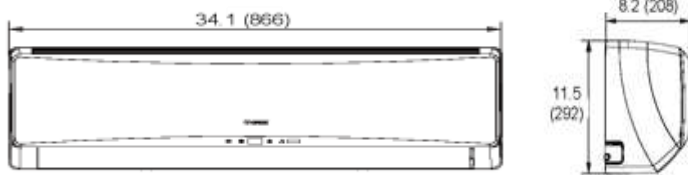

Liquid Line Valve	1/4-in OD Flared
Suction/Gas Line Valve	1/2-in OD Flared
Drain Connector	5/8-in OD

Note: Size Refrigerant lines based on evaporator port sizes.

Rated Cooling (BtuH)	Rated Heating	Max. CFM	Dehumid. (Pt/Hr)	Min/Max Sound Power dB(A)**
9,000	9,800	418	1.9	23/43
12,000	13,000	453	3	24/44

18,000 BTUH MODEL

Model # TERRA18HP230V1BH 18,000 BTUH 230V

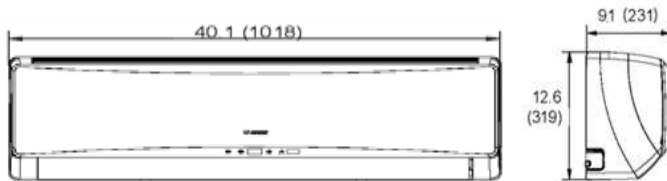

Liquid Line Valve	1/4-in OD Flared
Suction/Gas Line Valve	5/8-in OD Flared
Drain Connector	5/8-in OD

Note: Size Refrigerant lines based on evaporator port sizes.

Rated Cooling (BtuH)	Rated Heating	Max. CFM	Dehumid. (Pt/Hr)	Min/Max Sound Power dB(A)**
18,000	19,000	559	3.8	33/51

**Sound Power ratings are per AHRI 270 and AHRI 350

Specifications are subject to change without notice. Manufacturer reserves the right to discontinue or modify specifications or designs

without notice or without incurring obligations. All rights reserved.

Units: inch

9,000 BTUH MODELS

Model # CROWN09HP230V1AH 9,000 BTUH 230V

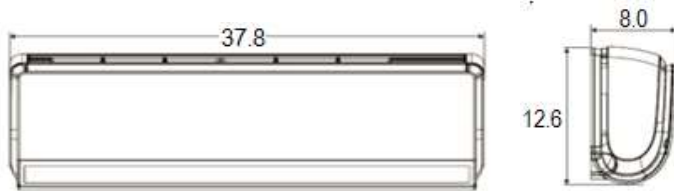

Liquid Line Valve	1/4-in OD Flared
Suction/Gas Line Valve	1/2-in OD Flared
Drain Connector	5/8-in OD

Note: Size Refrigerant lines based on evaporator port sizes.

Rated Cooling (BtuH)	Rated Heating	Max. CFM	Dehumid. (Pt/Hr)	Min/Max Sound Power dB(A)**
9,000	9,000	412	1.7	22/41

12,000 BTUH MODEL

Model # CROWN12HP230V1BH 12,000 BTUH 230V

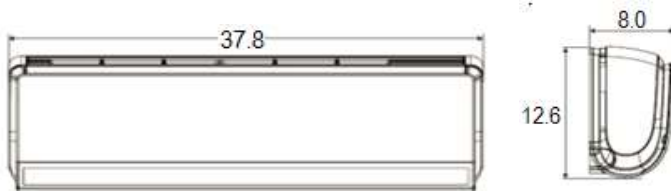

Liquid Line Valve	1/4-in OD Flared
Suction/Gas Line Valve	1/2-in OD Flared
Drain Connector	5/8-in OD

Note: Size Refrigerant lines based on evaporator port sizes.

Rated Cooling (BtuH)	Rated Heating	Max. CFM	Dehumid. (Pt/Hr)	Min/Max Sound Power dB(A)**
12,000	13,000	471	3.0	23/42

18,000 BTUH MODEL

Model # CROWN18HP230V1AH 18,000 BTUH 230V

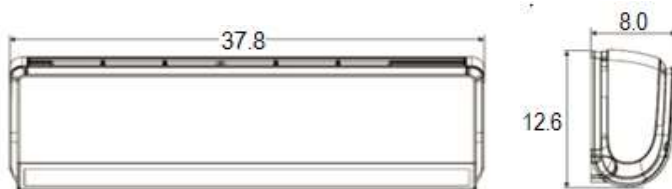

Liquid Line Valve	1/4-in OD Flared
Suction/Gas Line Valve	5/8-in OD Flared
Drain Connector	5/8-in OD

Note: Size Refrigerant lines based on evaporator port sizes.

Rated Cooling (BtuH)	Rated Heating	Max. CFM	Dehumid. (Pt/Hr)	Min/Max Sound Power dB(A)**
18,000	19,000	530	3.8	26/48

**Sound Power ratings are per AHRI 270 and AHRI 350

Specifications are subject to change without notice. Manufacturer reserves the right to discontinue or modify specifications or designs

without notice or without incurring obligations. All rights reserved.

COOLING CAPACITY (BTUH)

Indoor Units Combinations	Rated System Capacity (BtuH)	Indoor Unit A (BtuH)	Indoor Unit B (BtuH)	Indoor Unit C (BtuH)	Indoor Unit D (BtuH)
9K + 9K	18,000	9,000	9,000	NA	NA
9K + 12K	21,000	9,000	12,000	NA	NA
9K + 18K	25,000	8,400	16,600	NA	NA
12K + 12K	24,000	12,000	12,000	NA	NA
12K + 18K	25,000	10,000	15,000	NA	NA
18K + 18K	25,500	12,750	12,750	NA	NA
9K + 9K + 9K	26,001	8,667	8,667	8,667	NA
9K + 9K + 12K	26,000	8,000	8,000	10,000	NA
9K + 9K + 18K	26,000	7,000	7,000	12,000	NA
9K + 12K + 12K	26,000	6,000	10,000	10,000	NA
12K + 12K + 12K	26,001	8,667	8,667	8,667	NA

HEATING CAPACITY (BTUH)

Indoor Units Combinations	Rated System Capacity (BtuH)	Indoor Unit A (BtuH)	Indoor Unit B (BtuH)	Indoor Unit C (BtuH)	Indoor Unit D (BtuH)
9K + 9K	19,000	9,500	9,500	NA	NA
9K + 12K	22,500	9,500	13,000	NA	NA
9K + 18K	27,000	9,000	18,000	NA	NA
12K + 12K	26,000	13,000	13,000	NA	NA
12K + 18K	28,000	11,200	16,800	NA	NA
18K + 18K	28,500	14,250	14,250	NA	NA
9K + 9K + 9K	29,001	9,667	9,667	9,667	NA
9K + 9K + 12K	29,000	9,000	9,000	11,000	NA
9K + 9K + 18K	29,000	6,000	6,000	17,000	NA
9K + 12K + 12K	29,000	6,000	11,500	11,500	NA
12K + 12K + 12K	29,001	9,667	9,667	9,667	NA

Capacity data is based on the following conditions :

Cooling Nominal Test Conditions

Indoor: 80°F DB/67°F WB
 Outdoor: 95°F DB/75°F WB

Heating Nominal Test Conditions

Indoor: 70°F DB/60°F WB
 Outdoor: 47°F DB/43°F W

COOLING PERFORMANCE

		Indoor Ambient Temperature											
		70°F (21°C)			75°F (24°C)			80°F (27°C)			90°F (32°C)		
		59°F (15°C)			63°F (17°C)			67°F (19°C)			73°F (23°C)		
DB	WB	TC	SC	Input Power	TC	SC	Input Power	TC	SC	Input Power	TC	SC	Input Power
		(BtuH)	(BtuH)	(watts)	(BtuH)	(BtuH)	(watts)	(BtuH)	(BtuH)	(watts)	(BtuH)	(BtuH)	(watts)
Outdoor Ambient Temperature (DB)	-0.4°F (-18°C)	14,670	11,510	1,180	16,550	12,980	1,250	17,500	13,720	1,300	19,720	15,460	1,390
	5°F (-15°C)	15,050	11,800	1,180	16,970	13,320	1,260	18,160	14,240	1,300	20,220	15,860	1,390
	14°F (-10°C)	16,590	13,010	1,200	17,710	14,680	1,270	19,780	15,510	1,320	22,290	17,480	1,410
	23°F (-5°C)	18,170	14,260	1,200	20,700	16,240	1,270	22,270	17,470	1,310	24,500	19,220	1,400
	32°F (0°C)	19,103	14,986	1,196	21,764	14,466	1,265	22,379	17,543	1,309	25,759	20,204	1,404
	41°F (5°C)	20,083	15,754	1,257	22,880	15,208	1,330	23,527	18,442	1,376	27,080	21,240	1,476
	50°F (10°C)	20,919	16,411	1,310	23,833	15,841	1,386	24,507	19,211	1,433	28,209	22,125	1,538
	59°F (15°C)	22,040	17,290	1,380	25,110	16,690	1,460	25,820	20,240	1,510	29,720	23,310	1,620
	68°F (20°C)	24,961	19,577	2,028	26,521	20,797	2,092	28,341	22,228	2,219	32,501	25,494	2,375
	77°F (25°C)	24,666	19,349	2,082	26,235	20,578	2,146	28,081	22,026	2,283	32,241	25,283	2,448
	86°F (30°C)	23,453	18,392	2,329	25,013	19,621	2,402	27,301	21,412	2,548	31,245	24,502	2,731
	95°F (35°C)	22,196	17,409	2,503	23,748	18,620	2,576	26,001	20,394	2,740	29,927	23,475	2,932
	104°F (40°C)	21,122	16,566	2,585	22,664	17,777	2,667	25,325	19,867	2,831	28,853	22,623	3,032
	113°F (45°C)	20,038	15,714	2,640	21,581	16,926	2,722	24,250	19,015	2,895	27,769	21,781	3,096
118°F (48°C)	19,501	15,293	2,667	20,801	16,311	2,749	23,401	18,357	2,923	26,781	21,008	3,124	

HEATING PERFORMANCE

		Indoor Ambient Temperature											
		70°F (21°C)			75°F (24°C)			80°F (27°C)			90°F (32°C)		
		59°F (15°C)			63°F (17°C)			67°F (19°C)			73°F (23°C)		
DB	WB	TC	SC	Input Power	TC	SC	Input Power	TC	SC	Input Power	TC	SC	Input Power
		(BtuH)	(BtuH)	(watts)	(BtuH)	(BtuH)	(watts)	(BtuH)	(BtuH)	(watts)	(BtuH)	(BtuH)	(watts)
Outdoor Ambient Temperature (DB)	-4°F (-20°C)	15,660	15,660	1,440	15,220	15,220	1,470	15,070	15,070	1,490	14,550	14,550	1,550
	0°F (-18°C)	16,974	16,974	1,577	16,485	16,485	1,609	16,177	16,177	1,669	15,751	15,751	1,708
	5°F (-15°C)	17,442	17,442	1,613	16,939	16,939	1,645	16,622	16,622	1,706	16,187	16,187	1,746
	7°F (-14°C)	17,909	17,909	1,648	17,393	17,393	1,682	17,067	17,067	1,744	16,622	16,622	1,784
	17°F (-8°C)	19,224	19,224	1,719	18,662	18,662	1,754	18,308	18,308	1,819	17,828	17,828	1,861
	28°F (-2°C)	21,716	21,716	1,832	21,145	21,145	1,869	20,538	20,538	1,938	20,293	20,293	1,983
	38°F (3°C)	27,000	27,000	2,108	26,429	26,429	2,151	25,831	25,831	2,230	25,577	25,577	2,282
	47°F (8°C)	30,517	30,517	2,192	29,592	29,592	2,237	29,003	29,003	2,320	28,206	28,206	2,374
	57°F (14°C)	31,523	31,523	2,235	30,571	30,571	2,281	29,964	29,964	2,365	29,130	29,130	2,420
	68°F (20°C)	32,810	32,810	2,310	31,810	31,810	2,360	31,180	31,180	2,450	30,310	30,310	2,500
	77°F (25°C)	33,570	33,570	2,370	32,550	32,550	2,420	31,900	31,900	2,510	31,020	31,020	2,570

LEGEND

DB --- Dry Bulb
 WB --- Wet Bulb
 TC --- Total Net Cooling Capacity (BtuH)
 SC --- Sensible Capacity (BtuH)
 Input Power---(Watts)

Specifications are subject to change without notice. Manufacturer reserves the right to discontinue or modify specifications or designs without notice or without incurring obligations. All rights reserved.