

Submittal Data: LIVS36HP230V1A 36,000 BTU/H (208/230V) Wall Mounted Heat Pump System

Job Name	Location	Date
----------	----------	------

Purchaser	Engineer
-----------	----------

Submitted To	For	<input type="checkbox"/> Reference	<input type="checkbox"/> Approval	<input type="checkbox"/> Construction
--------------	-----	------------------------------------	-----------------------------------	---------------------------------------

Unit Designation	Schedule No.
------------------	--------------

- GENERAL FEATURES**
- High Efficiency DC Inverter Technology
 - Compact and Quiet Design
 - Vertical Swing Louver
 - Wireless Remote with LCD Display
 - XK-41 Wired Tether Controller (Sold Separately)
 - Low Ambient Cool to 0 deg F
 - Blue Fin Condenser Coil
 - 5 year Limited Parts Warranty
 - 7 year Limited Compressor Warranty



System Ratings

Cooling	
Rated Capacity	33,600 BTU/H
Capacity Range	7,400-36,000 BTU/H
Power Input (Max)	3,900 W
SEER	16.0
EER	8.2
Heating at 47° F	
Rated Capacity	34,600 BTU/H
Capacity Range	15,000-36,000 BTU/H
Power Input (Max)	3,800 W
HSPF	8.2
COP	2.7
Heating at 17° F	
Rated Capacity	20,600 BTU/H
Operating Range	
Cooling	(Max) 115°F (46 C)
	(Min) 0°F (-18 C)
Heating	(Max) 75°F (24 C)
	(Min) -4°F (-20 C)

Indoor Unit Data

Fan Motor	Type	Cross-Flow
	Output Power	70 W
	FLA	0.4 A
Airflow		
Cooling	Wet (Lo/Hi)	412/736 CFM
Heating	Dry (Lo/Hi)	412/736 CFM
Sound Pressure Level		
Cooling	(Min/Max)	41/56 db(A)
Heating	(Min/Max)	41/56 db(A)
Dehumidification		7.40 pt/hr

Refrigerant Piping Data

Gas Pipe Size (OD)	5/8-in
Liquid Pipe Size (OD)	1/4-in
Connection Method	Flared
Factory Charge	91.7 oz
Additional Charge	0.54 oz
Pre-Charge Length	25-ft
MAX Refrigerant Pipe Length	98-ft
MIN Refrigerant Pipe Length	10-ft
MAX Refrigerant Pipe Elevation	33-ft

Outdoor Unit Data

Compressor	Type	DC Inverter Driven Rotary
	RLA	17.5 A
Refrigerant Type		R410A
Fan Motor	Output Power	170 W
	FLA	0.73 A
Sound Pressure		
Cooling/Heating		65/65 db(A)

Electrical Data

Power Supply	
Normal Operational Voltage	208/230 V, 1 Phase, 60 Hz
Voltage Range	187 - 253 V
MCA	24.0 A
MOCP/Breaker Size	40 A
Main Power Wire Size	8-2 AWG

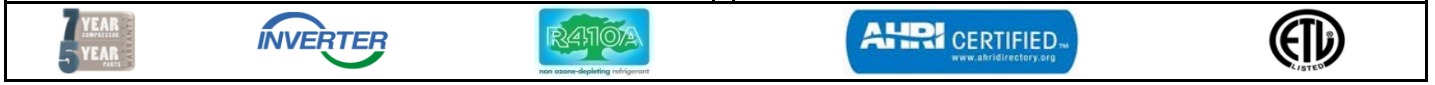

COOLING PERFORMANCE (BtuH)*

Outdoor Ambient DB	Indoor Ambient Temperature							
	68F DB (20C)		73F DB (23C)		80F DB (27C)		82F DB (28C)	
	57F WB (14C)		61F WB (16C)		67F WB (19C)		68F WB (20C)	
	TC	SHC	TC	SHC	TC	SHC	TC	SHC
0°F	18,931	14,847	19,999	15,679	22,571	17,703	22,909	17,968
5°F	19,555	15,337	20,658	16,196	23,315	18,286	23,665	18,561
14°F	20,803	16,316	21,977	17,230	24,803	19,454	25,175	19,745
23°F	22,792	17,879	24,379	19,123	27,933	21,909	28,352	22,237
32°F	23,932	18,773	25,598	20,079	29,330	23,004	29,770	23,349
41°F	25,129	19,712	26,878	21,083	30,796	24,154	31,258	24,517
50°F	26,385	20,697	28,222	22,138	32,336	25,362	32,821	25,742
59°F	27,640	21,677	29,564	23,186	32,379	25,388	32,864	25,769
68°F	31,303	24,551	33,259	26,081	35,542	27,876	36,075	28,294
77°F	30,933	24,265	32,900	25,806	35,216	27,622	35,744	28,037
86°F	29,412	23,065	31,368	24,606	34,237	26,852	34,751	27,255
95°F	27,836	21,832	29,781	23,351	32,607	25,575	33,096	25,958
104°F	26,488	20,775	28,422	22,294	31,759	24,914	32,236	25,288
113°F	25,129	19,707	27,064	21,226	30,411	23,846	30,868	24,204
115°F	25,000	19,605	26,897	21,095	30,228	23,703	30,681	24,059

HEATING PERFORMANCE (BtuH)*

Outdoor Ambient DB	Indoor Ambient Temperature							
	68F DB (20C)		73F DB (23C)		80F DB (27C)		86F DB (30C)	
	57F WB (14C)		61F WB (16C)		67F WB (19C)		72F WB (22C)	
	TC	SHC	TC	SHC	TC	SHC	TC	SHC
-4°F	17,515	17,515	17,220	17,220	16,718	16,718	16,525	16,525
0°F	18,979	18,979	18,663	18,663	18,104	18,104	17,894	17,894
6°F	20,022	20,022	19,685	19,685	19,104	19,104	18,874	18,874
10°F	20,854	20,854	20,506	20,506	19,895	19,895	19,664	19,664
16°F	21,486	21,486	21,128	21,128	20,489	20,489	20,253	20,253
19°F	21,896	21,896	21,538	21,538	20,885	20,885	20,643	20,643
24°F	24,361	24,361	23,992	23,992	23,322	23,322	23,108	23,108
32°F	27,226	27,226	26,857	26,857	26,156	26,156	25,972	25,972
41°F	30,501	30,501	30,143	30,143	29,395	29,395	29,248	29,248
43°F	31,323	31,323	30,954	30,954	30,208	30,208	30,069	30,069
47°F	34,040	34,040	33,450	33,450	32,416	32,416	31,997	31,997
53°F	34,377	34,377	33,777	33,777	32,739	32,739	32,313	32,313
59°F	35,167	35,167	34,546	34,546	33,478	33,478	33,050	33,050
64°F	35,915	35,915	35,283	35,283	34,197	34,197	33,756	33,756
70°F	36,589	36,589	35,957	35,957	34,843	34,843	34,398	34,398
75°F	37,105	37,105	36,452	36,452	35,333	35,333	34,872	34,872

* Maximum system capacity

TC- Total Capacity (BtuH)
 SHC- Sensible Capacity (BtuH)



MINIMUM SPACING REQUIREMENTS

Units: inch (mm)

INDOOR

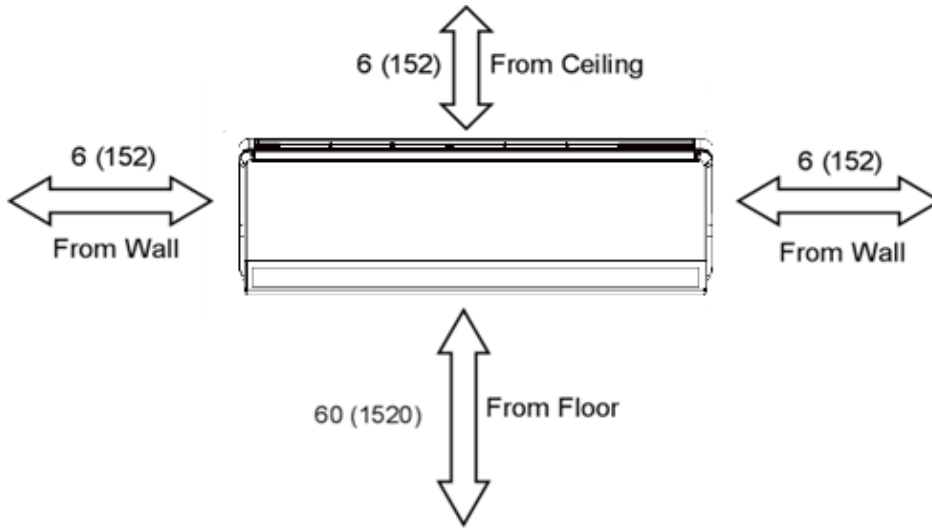

Units: inch (mm)

OUTDOOR

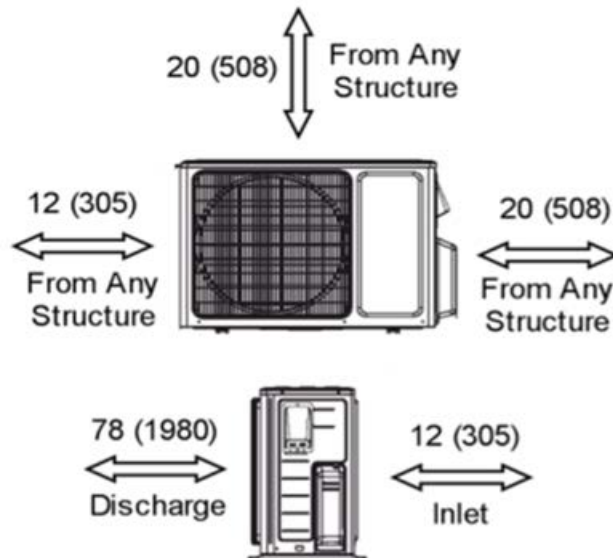

DIMENSIONAL SPECIFICATIONS

LIVS36HP230V1A

INDOOR UNIT DIMENSIONS

Units: inch

Model No: LIVS36HP230V1AH

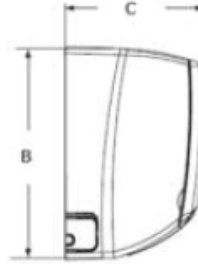
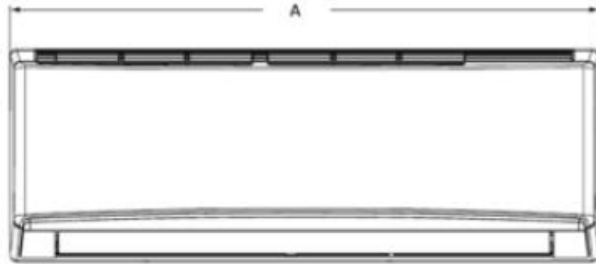

Dimensions	
A	53.2
B	12.8
C	10.0

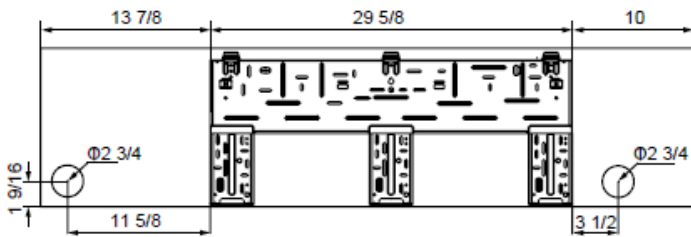

Weight (Net/Gross) 41.9/57.3 lbs

Liquid Line Valve	1/4-in OD Flared
Gas Line Valve	5/8-in OD Flared
Drain Connector	5/8-in OD

OUTDOOR UNIT DIMENSIONS

Units: inch

Model No: LIVS36HP230V1AO

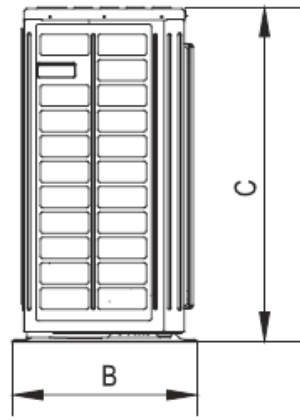
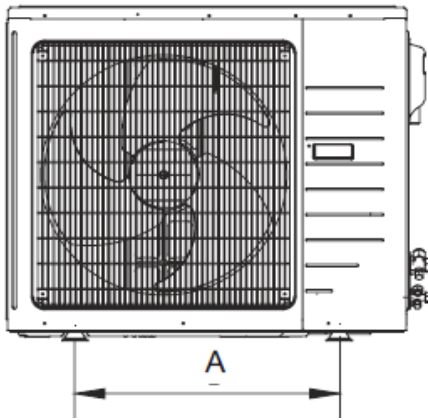

Dimensions	
A	24.0
B	16.8
C	31.2
D	39.4
E	15.6

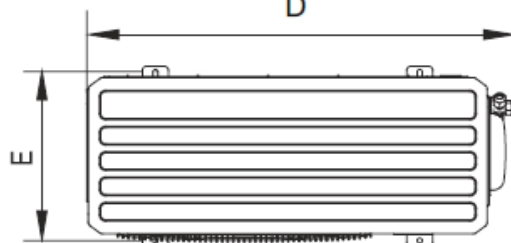

Weight (Net/Gross) 161/170 lbs

Liquid Line Valve	1/4-in OD Flared
Gas Line Valve	5/8-in OD Flared

Notes:

1. Recommended Interconnecting Cable Type 14 AWG 4 Stranded Bare Copper Conductors THHN 600V Wire
2. Power wiring cable size must comply with applicable national and local codes.
3. Test conditions are based on AHRI 210/240.



Specifications are subject to change without notice. Manufacturer reserves the right to discontinue or modify specifications or designs without notice or without incurring obligations. All rights reserved.